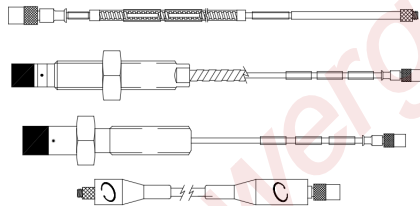
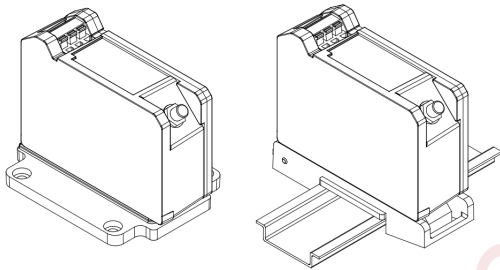


# 3300 XL NSv Proximity Transducer System

## Datasheet

Bently Nevada Machinery Condition Monitoring

147385 Rev. P



### Description

The 3300 XL NSv Proximity Transducer system is intended for use with centrifugal air compressors, refrigeration compressors, process gas compressors, and other machines with tight installation requirements. The 3300 XL NSv Proximity Transducer System consists of:

- a 3300 NSv probe
- a 3300 NSv extension cable
- a 3300 XL NSv Proximator Sensor<sup>(1)</sup>

The primary uses for the 3300 XL NSv Transducer System are for areas where counter bore, sideview, or rearview restrictions limit the use of standard Bently Nevada 3300 and 3300 XL 5 and 8 mm Transducer Systems. It is also ideal for small target applications, such as measuring radial vibration on shafts smaller than 51 mm (2 in) or axial position on flat targets smaller than 15 mm (0.6 in). It is primarily used in the following applications on fluid-filled bearing machines where a small shaft or reduced side-view is present:

- Radial vibration and radial position measurements
- Axial (thrust) position measurements
- Tachometer and zero speed measurements
- Phase reference (Keyphasor signals)

The 3300 XL NSv Transducer System design allows it to replace both the 3300 RAM Transducer Systems and the 3000-series or 7000-series 190 Transducer System. Upgrades from the 3300 RAM system to the 3300 XL NSv system may use the existing probe, extension cable, and monitoring



system with 3300 XL NSv Proximitior Sensor. Upgrades from the 3000-series or 7000-series Transducer System must replace the probe, extension cable, and Proximitior Sensor with NSv components.

The 3300 XL NSv Transducer System has an Average Scale Factor of 7.87 V/mm (200 mV/mil), which is the most common output for eddy current transducers. Its enhanced side-view and small target characteristics give it a shorter linear range than the Bently Nevada 3300 XL-series 5 and 8 mm Transducer System. The 1.5 mm (60 mils) of linear range exceeds the linear range of the 3000-series 190 Transducer System.



Although the terminals and connector on the Proximitior Sensor have protection against electrostatic discharge, take reasonable precautions to avoid electrostatic discharge during handling.

## Proximitior Sensor

The 3300 XL NSv Proximitior Sensor has similar features to those found in the 3300 XL 8 mm Proximitior Sensor. Its thin design allows the user to mount it in either a high-density DIN-rail installation or a more traditional panel mount configuration. Improved RFI/EMI immunity allows the 3300 XL NSv Proximitior Sensor to achieve European CE mark approvals without any special mounting considerations. This RFI immunity also prevents nearby high frequency radio signals from adversely affecting the transducer system. SpringLoc terminal strips on the Proximitior Sensor require no special installation tools and facilitate faster, highly robust field wiring connections.

## Proximity Probe and Extension Cable

The 3300 NSv probe and extension cable are mechanically and electrically compatible and interchangeable with Bently Nevada's previous 3300 RAM proximity probe and extension cable. The NSv probe has increased chemical resistance compared to the 3300 RAM probe, which allows its use in many process

compressor applications. The side-view characteristics of the 3300 NSv probe are also superior to those of the 3000-series 190 probe when gapping the 3300 NSv probe at the same distance from the probe target.

The 3300 NSv probe comes in varying probe case configurations, including armored and unarmored 1/4-28, 3/8-24, M8X1 and M10X1 probe threads. The reverse mount 3300 NSv probe comes standard with either 3/8-24 or M10X1 threads. All components of the transducer system have gold-plated brass ClickLoc connectors. ClickLoc connectors lock into place and prevent the connection from loosening. The patented TipLoc molding method provides a robust bond between the probe tip and the probe body. Bently Nevada's patented CableLoc design provides 220 N (50 lb) of pull strength and securely attaches the probe cable to the probe tip. Connector protectors are recommended for use on the probe-to-extension cable connection, as well as on the cable-to-Proximitior Sensor connection. Connector protectors prevent most liquids from entering into the ClickLoc connectors and adversely affecting the electrical signal(2).

Notes:

(1) Proximitior Sensors are supplied by default from the factory calibrated to AISI 4140 steel. Calibration to other target materials is available upon request.

(2) Silicone tape is also provided with each 3300 NSv extension cable and can be used instead of connector protectors. Silicone tape is not recommended in applications where the probe-to-extension cable connection will be exposed to turbine oil.

## Specifications

Unless otherwise noted, the following specifications are for a 3300 XL NSv Proximitor Sensor, extension cable and probe between 0°C and +45°C (+32°F to +113°F) at a maximum altitude of 2000 m, with a -24 Vdc power supply, a 10 kΩ load, a Bently Nevada supplied AISI 4140 steel target that is 31 mm (1.2 in) diameter or larger, and a probe gap of 1.0 mm (40 mils). The system accuracy and interchangeability specifications do not apply when using a transducer system calibrated to any target other than a Bently Nevada AISI 4140 steel target.

## Electrical

Proximitor Sensor Input	Accepts one non-contacting 3300 RAM or 3300 NSv Proximity Probe and Extension Cable.
Power	Requires -17.5 Vdc to -26 Vdc without barriers at 12 mA maximum consumption, -23 Vdc to -26 Vdc with barriers. Operation at a more positive voltage than -23.5 Vdc can result in reduced linear range.
Supply Sensitivity	Less than 2 mV change in output voltage per volt change in input voltage.
Output resistance	50 Ω
Probe dc Resistance	
Probe Length (m)	Resistance from the Center Conductor to the Outer Conductor ( $R_{PROBE}$ ) (ohms)
0.5	4.0 ± 0.5
1.0	4.2 ± 0.5
5.0	5.3 ± 0.7

7.0	5.9 ± 0.9
Extension cable dc resistance	Center conductor: 0.220 Ω/m (0.067 Ω/ft) Shield: 0.066 Ω/m (0.020 Ω/ft)
Extension cable capacitance	69.9 pF/m (21.3 pF/ft) typical
Field Wiring	0.2 to 1.5 mm <sup>2</sup> (16 to 24 AWG)[0.25 to 0.75 mm <sup>2</sup> (18 to 23 AWG) with ferrules]. Recommend using three-conductor shielded triad cable. Maximum length of 305 meters (1,000 feet) between the 3300 XL NSv Proximitor Sensor and the monitor. See the frequency response graphs Figure 16 and Figure 17 for signal rolloff at high frequencies when using longer field wiring lengths.
Linear Range	1.5 mm (60 mils). Linear range begins at approximately 0.25 mm (10 mils) from target and is from 0.25 to 1.75 mm (10 to 70 mils) (approximately -1 to -13 Vdc).
Recommended Gap Setting	1.0 mm (40 mils)
System performance over ambient temperature range (0°C to 45°C)	
Incremental Scale Factor (ISF)	7.87 V/mm (200 mV/mil) +12.5%/-20% including interchangeability error when measured in increments of 0.25 mm (10 mils) over the 1.5 mm (60 mil) linear range.
Deviation from best fit straight line (DSL)	Less than ±0.06 mm (±2.3 mils).

<p>Frequency Response</p>	<p>0 to 10 kHz: +0, -3 dB typical, with up to 305 meters (1000 feet) of field wiring.</p>		<p>Minimum (standard X-Y probe configuration): 30 mm (1.2 in)</p>
<p>Target Size (flat target)</p>	<p>Minimum: 8.9 mm (0.35 in) diameter</p> <p>Recommended minimum: 13 mm (0.5 in) diameter</p> <p>Axial position measurements on shaft diameters smaller than 13 mm (0.5 in) will generally result in a change in scale factor. Reducing the gap between the probe and target will help limit the change in scale factor. See Figure 12 for additional information.</p>	<p>Shaft Diameter</p>	<p>Minimum (X-Y proximity probes offset axially by 23 mm [0.9 in]): 20 mm (0.8 in)</p> <p>Measurements on shaft diameters smaller than 30 mm (1.2 in) usually require close spacing of radial vibration or axial position transducers. This creates the potential for their electromagnetic emitted fields to interact with one another (cross-talk), resulting in erroneous readings. To prevent cross-talk, maintain minimum separation of transducer tips of at least 25 mm (1.0 in) for axial position measurements or 23 mm (0.9 in) for radial vibration measurements. See <a href="#">Figure 14: Probe Cross-talk with Probes Mounted in Parallel</a> and <a href="#">Figure 15: Probe Cross-talk with Probes Mounted in X-Y Configuration</a>. Radial vibration or radial position measurements on shaft diameters smaller than 20 mm (0.8 in) will generally result in greater than a 10% change in Average Scale Factor (ASF). See Figure 13 for additional information.</p>

Counterbore	Minimum: 9.5 mm (0.375 in)
	Recommended minimum: 13 mm (0.5 in)
	Counterbores smaller than 13 mm (0.5 in) generally result in a change in scale factor at far gaps. Reducing the gap between the probe and the target will allow the transducer system to maintain its Average Scale Factor (ASF) over a reduced linear range. See Figure 9 for additional information.

Extension Cable Material	75 Ω coaxial, fluoroethylene propylene (FEP) insulated.
Proximator Sensor Material	A380 aluminum
System Length	5 or 7 meters including extension cable
Extension Cable Armor (optional)	Flexible AISI 302 SST with/without FEP outer jacket.
Tensile Strength (maximum rated)	220 N (50 lb) probe case to probe lead. 220 N (50 lb) at probe lead to extension cable connectors. 220 N (50 lb) probe case to stainless steel armor.
Connector material	Gold-plated brass

**Effects of 60 Hz Magnetic Fields Up to 300 Gauss (5 meter system)**

**Output voltage in mil pp/gauss**

Gap	Proximator Sensor	Probe	Ext. Cable
0.25 mm (10 mils)	0.006	0.001	0.001
1.0 mm (40 mils)	0.007	0.002	0.001
1.75 mm (70 mils)	0.008	0.002	0.003

**Connector-to-connector Torque**

Probe Case Torque	Maximum Rated	Recommended
1/4-28 or M8X1 probe cases	7.3 N•m (65 in•lb)	5.1 N•m (45 in•lb)
3/8-24 or M10X1 probe cases	33.9 N•m (300 in•lb)	11.3 N•m (100 in•lb)
3/8-24 or M10X1 probe cases – first three threads	22.6 N•m (200 in•lb)	7.5 N•m (66 in•lb)
Reverse mount probes	22.6 N•m (200 in•lb)	7.5 N•m (66 in•lb)
Recommended torque	Finger tight	
Maximum torque	0.56 N•m (5 in•lb)	


**Mechanical**


Probe Tip Material	Polyphenylene sulfide (PPS).
Probe Case Material	AISI 304 stainless steel (SST).
Probe Cable Specifications	75 Ω coaxial, fluoroethylene propylene (FEP) insulated probe cable in the following total probe lengths: 0.5, 1, 5, or 7 meters.

Minimum Bend Radius (with or without sst armor)	25.4 mm (1.0 in)
System Weight (typical)	
Probe	Approximately 14 to 150 g (0.5 to 5.3 oz)
Extension Cable	45 g/m (0.5 oz/ft)
Armored Extension Cable	64 g/m (0.7 oz/ft)
Proximator Sensor	255 g (9 oz)

### Thread Engagement Limits

Probe Case Thread	Maximum Length of Thread Engagement
<b>1/4-28</b>	0.375 in
<b>3/8-24</b>	0.563 in
<b>M8x1</b>	12 mm
<b>M10x1</b>	15 mm


 Maximum thread engagement lengths are per the industry standard of 1.5 times the nominal thread diameter. A fit class matching that of the external probe thread is assumed for all internal threads. Applications with thread engagement lengths exceeding the values in the table above may exhibit binding during installation. Contact your Bently Nevada representative if you require probe thread engagement lengths exceeding the values above. Bently Nevada does not replace proximity probes under warranty due to excessive thread engagement lengths.

 When drilling and tapping a mounting hole **for a 1/4-28 probe**, a **#3 or larger tap drill** is recommended.

### Environmental Limits

#### Probe Temperature Range

Operating Temperature	-52°C to +177°C (-62°F to +351°F)
Storage Temperature	-52°C to +177°C (-62°F to +351°F)

 Exposing the probe to temperatures below -34°C (-30°F) for a sustained period of time may cause premature failure of the pressure seal.

#### Extension Cable Temperature Range

Operating and Storage Temperature	-52°C to +177°C (-62°F to +351°F)
-----------------------------------	-----------------------------------

#### Proximator Sensor Temperature Range

Operating Temperature	-52°C to +100°C (-62°F to +212°F)
Storage Temperature	-52°C to +105°C (-62°F to +221°F)

Relative Humidity	100% condensing, non-submersible when connectors are protected. Tested to IEC 68-2-3 damp heat.
-------------------	---

Probe  
Pressure

3300 NSv probes are designed to seal differential pressure between the probe tip and case. The probe sealing material consists of a Viton O-ring. Probes are not pressure tested prior to shipment. Contact our custom design department if you require a test of the pressure seal for your application.



It is the responsibility of the customer or user to ensure that all liquids and gases are contained and safely controlled should leakage occur from a proximity probe. In addition, solutions with high or low pH values may erode the tip assembly of the probe causing media leakage into surrounding areas. Bently Nevada will not be held responsible for any damages resulting from leaking 3300 NSv Proximity Probes. In addition, 3300 NSv Proximity Probes does not be replaced under the service plan due to probe leakage.

## Compliance and Certifications

### FCC

This device complies with part 15 of the FCC Rules. Operation is subject to the following two conditions:

- This device may not cause harmful interference.
- This device must accept any interference received, including interference that may cause undesired operation.

### EMC

European Community Directive:

EMC Directive 2014/30/EU

Standards

EN 61000-6-2; Immunity for Industrial Environments

EN 61000-6-4; Emissions for Industrial Environments

### RoHS

European Community Directive:

RoHS Directive 2011/65/EU

### Maritime

2019 Rules for Conditions of Classification,

Part 1, 1-1-1/7.7, 1-1-A3, 1-1-A4

2019 Rules for Conditions of Classification,

Part 1, Offshore Units and Structures

1-1-4/9.7, 1-1-A2, 1-1-A3

### Functional Safety

SIL 2, HFT = 0

SIL 3, HFT = 1

## Hazardous Area Approvals



For the detailed listing of country and product-specific approvals, refer to the [Approvals Quick Reference Guide \(108M1756\)](#).

For additional technical documentation, please log in to [bntechsupport.com](http://bntechsupport.com) and access the Bently Nevada Media Library.

### cNRTLus

#### 3300 XL Proximito Sensor

<p><b>ia</b></p> <p>When installed with intrinsically safe zener barriers per drawing 141092 or when installed with galvanic isolators.</p>	<p>Class I, Zone 0: AEx/Ex ia IIC T4/T5 Ga; Class I, Groups A, B, C, and D, Class II, Groups E, F and G, Class III;</p> <p>T5 @ Ta= -55°C to + 40°C.                      T4 @ Ta= -55°C to + 80°C.</p>
<p><b>nA, ec</b></p> <p>When installed with non-incendive circuit connected per drawing 140979.</p>	<p>Class I, Zone 2: AEx/Ex nA IIC T4/T5 Gc; Class I, Division 2, Groups A, B, C, and D; Class I, Zone 2: AEx/Ex ec IIC T4/T5 Gc; Class I, Division 2, Groups A, B, C, and D;</p> <p>T5 @ Ta= -55°C to + 40°C                      T4 @ Ta= -55°C to + 80°C</p>

#### 3300 XL Probe



<p><b>ia</b></p> <p>When installed with intrinsically safe zener barriers per drawing 141092 or when installed with galvanic isolators.</p>	<p>Class I, Zone 0: AEx/Ex ia IIC T5...T1 Ga; Class I, Groups A, B, C, and D, Class II, Groups E, F, and G, Class III;</p> <p>(see Temperature Schedule table to follow)</p>
---	--



<p><b>nA, ec</b></p> <p>When installed with non-incendive circuit connected per drawing 140979.</p>	<p>Class I, Zone 2: AEx/Ex nA IIC T5...T1 Gc;                  Class I, Division 2, Groups A, B, C, D;                  Class I, Zone 2: AEx/Ex ec IIC T5...T1 Gc;                  Class I, Division 2, Groups A, B, C, and D;                  (see Temperature Schedule table to follow)</p>
---	---

## ATEX/IECEx



### 3300 XL Proximito Sensor

<p><b>ia</b></p>	<p style="text-align: right;"></p> <p>II 1 G                  Ex ia IIC T4/T5 Ga                  Ex ia III C T90C/T105C Dc                  For EPL Dc:                  T105C @ Ta = -55°C to 100°C                  T90C @ Ta = -55°C to +85°C</p> <table border="1" style="width: 100%;"> <tr> <td>Ui= -28V</td> <td>Uo= -28V</td> </tr> <tr> <td>Ii= 140mA</td> <td>Io= 140mA</td> </tr> <tr> <td>Pi= 0.91W</td> <td>Po= 0.742W</td> </tr> <tr> <td>Ci= 47nF</td> <td>Co= 1.5nF</td> </tr> <tr> <td>Li= 1460µH</td> <td>Lo= 610µH</td> </tr> </table>	Ui= -28V	Uo= -28V	Ii= 140mA	Io= 140mA	Pi= 0.91W	Po= 0.742W	Ci= 47nF	Co= 1.5nF	Li= 1460µH	Lo= 610µH
Ui= -28V	Uo= -28V										
Ii= 140mA	Io= 140mA										
Pi= 0.91W	Po= 0.742W										
Ci= 47nF	Co= 1.5nF										
Li= 1460µH	Lo= 610µH										
<p><b>nA, ec</b></p>	<p style="text-align: right;"></p> <p>II 3 G                  Ex nA IIC T4/T5 Gc                  Ex ec IIC T4/T5 Gc</p> <table border="1" style="width: 100%;"> <tr> <td>Ui= -28V</td> <td>Ii= 140 mA</td> </tr> </table> <p>T5 @ Ta= -55°C to + 40°C                  T4 @ Ta= -55°C to + 80°C</p>	Ui= -28V	Ii= 140 mA								
Ui= -28V	Ii= 140 mA										

### 3300 XL Probe



Probe entity parameters are met when used with BN extension cables and connected to BN Prox.

<p><b>ia</b></p>	<p style="text-align: right;"></p> <p>II 1 G                  Ex ia IIC T5...T1 Ga,                  (see Temperature Schedule table to follow)                  Ex ia III C T90°C ... T280°C Dc                  For EPL Dc:</p> <table border="1" style="width: 100%;"> <tr> <td>Ui= -28V</td> <td>Ci = 1.5 nF</td> </tr> <tr> <td>Ii = 140 mA</td> <td>Li = 610 µH</td> </tr> <tr> <td>Pi = 0.91 W</td> <td></td> </tr> </table>	Ui= -28V	Ci = 1.5 nF	Ii = 140 mA	Li = 610 µH	Pi = 0.91 W	
Ui= -28V	Ci = 1.5 nF						
Ii = 140 mA	Li = 610 µH						
Pi = 0.91 W							
<p><b>nA, ec</b></p>	<p style="text-align: right;"></p> <p>II 3 G                  Ex nA IIC T5...T1 Gc,                  Ex ec IIC T5...T1 Gc,                  (see Temperature Schedule table to follow)</p> <table border="1" style="width: 100%;"> <tr> <td>Ui= -28V</td> <td>Ii= 140 mA</td> </tr> </table>	Ui= -28V	Ii= 140 mA				
Ui= -28V	Ii= 140 mA						

## Temperature Schedule

Temperature Classification	Ambient Temperature (Probe Only)
For EPL Ga and Gc	
T1	-55°C to +232°C
T2	-55°C to +177°C
T3	-55°C to +120°C
T4	-55°C to +80°C
T5	-55°C to +40°C
For EPL Dc	
T280°C @ Ta	-55°C to +232°C
T225°C @ Ta	-55°C to +177°C
T170°C @ Ta	-55°C to +120°C
T130°C @ Ta	-55°C to +80°C
T105°C @ Ta	-55°C to +100°C
T90°C @ Ta	-55°C to +40°C

## Hazardous Area Conditions of Safe Use

### **cNRTLus:**

#### **ia**

Install per Bently Nevada drawing 141092.

#### **nA, ec**

Install per Bently Nevada drawing 140979.

### **ATEX/IECEX:**

#### **ia**

Install per Bently Nevada drawing 141092.

#### **nA, ec**

The Proximitor must be installed so as to provide the terminals with a degree of protection of at least IP54.

## Ordering Information



For the detailed listing of country and product-specific approvals, refer to the [Approvals Quick Reference Guide \(108M1756\)](#).

For additional technical documentation, please log in to [bntechsupport.com](http://bntechsupport.com) and access the Bently Nevada Media Library.

### 3300 NSv Proximity Probes

**330901** 3300 NSv Probe, 1/4-28 UNF thread, without armor

**330902** 3300 NSv Probe, 1/4-28 UNF thread, with armor

**330908** 3300 NSv Probe, 3/8-24 UNF thread, without armor

**330909** 3300 NSv Probe, 3/8-24 UNF thread, with armor

**Part Number-AA-BB-CC-DD-EE**

#### A: Unthreaded Length Option



Unthreaded length must be at least 0.7 inch less than the case length.

Order in increments of 0.1 in

Length configurations:

Maximum unthreaded length: 9.2 in

Minimum unthreaded length: 0.0 in

Example: **04** = 0.4 in

#### B: Overall Case Length Option

Order in increments of 0.1 in

Threaded length configurations:

Maximum case length: 9.9 in

Minimum case length: 0.8 in

Example: **2 4** = 2.4 in

#### C: Total Length Option

**05** 0.5 meter (20 in)

**10** 1.0 meter (39 in)

**50** 5.0 meters (16.4 feet)

**70** 7.0 meters (23.0 feet)

#### D: Connector and Cable-Type Option

**01** Miniature coaxial ClickLoc connector with connector protector, standard cable

**02** Miniature coaxial ClickLoc connector, standard cable

**11** Miniature coaxial ClickLoc connector with connector protector, FluidLoc cable

**12** Miniature coaxial ClickLoc connector, FluidLoc cable

#### E: Agency Approval Option

**00** Not required

**05** Multiple Approvals

### 3300 NSv Proximity Probes, Metric

**330903** 3300 NSv Probe, M8X1 thread, without armor

**330904** 3300 NSv Probe, M8X1 thread, with armor

**330905** 3300 NSv Probe, M10X1 thread, without armor

**330910** 3300 NSv Probe, M10X1 thread, with armor

**Part Number-AA-BB-CC-DD-EE**

**A: Unthreaded Length Option**



Unthreaded length must be at least 20 mm less than the case length.

Order in increments of 10 mm.

Length configuration:

Maximum unthreaded length:

230 mm

Minimum unthreaded length:

0 mm

Example:

**06** = 60 mm

**B: Overall Case Length Option**

Order in increments of 10 mm.

Metric thread configurations:

Maximum length: 250 mm

Minimum length: 20 mm

Example: **06** = 60 mm

**C: Total Length Option**

**05** 0.5 meter (20 in)

**10** 1.0 meter (39 in)

**50** 5.0 meters (16.4 feet)

**70** 7.0 meters (23.0 feet)

**D: Connector and Cable-Type Option**

**01** Miniature coaxial ClickLoc connector with connector protector, standard cable

**02** Miniature coaxial ClickLoc connector, standard cable

**11** Miniature coaxial ClickLoc connector with connector protector, FluidLoc cable

**12** Miniature coaxial ClickLoc connector, FluidLoc cable

**E: Agency Approval Option**

**00** Not required

**05** Multiple Approvals

**3300 NSv Reverse Mount Probe**

**330906-02-12-CC-DD-EE** 3/8-24 UNF threads

**330907-05-30- CC-DD-EE** M10X1 threads

**C: Total Length Option**

**05** 0.5 meter (20 in)

**10** 1.0 meter (39 in)

**50** 5.0 meters (16.4 feet)

**70** 7.0 meters (23.0 feet)

**D: Connector Option**

**02** Miniature coaxial ClickLoc connector, standard cable


**12** Miniature coaxial ClickLoc connector, FluidLoc cable

**E: Agency Approval Option**

**00** Not required

Multiple Approvals

05

 For a shorter delivery time, order commonly stocked probes. Currently, stocked probes consist of the following part numbers: 330901-00-24-05-02-00, 330901-00-90-05-02-00, 330902-00-50-05-02-00, 330902-00-95-05-02-00, 330903-00-02-10-02-00, 330903-00-03-10-02-00, 330906-02-12-05-02-00.

**3300 XL NSv Proximitor Sensor**

**330980-AA-BB**

**A: Total Length and Mounting Option**


<b>50</b>	5.0 meters (16.4 feet) system length, panel mount
<b>51</b>	5.0 meters (16.4 feet) system length, DIN mount
<b>52</b>	5.0 meters (16.4 feet) system length, no mounting hardware <sup>1</sup>
<b>70</b>	7.0 meters (23.0 feet) system length, panel mount
<b>71</b>	7.0 meters (23.0 feet) system length, DIN mount
<b>72</b>	7.0 meters (23.0 feet) system length, no mounting hardware <sup>1</sup>

**B: Agency Approval Option**

<b>00</b>	Not required
<b>05</b>	Multiple approvals

**3300 NSv Extension Cable**

**330930-AAA-BB-CC**

 Make sure that the extension cable length and the probe length, when added together, equal the Proximitor Sensor total length.

**A: Cable Length Option**

<b>040</b>	4.0 meters (13.1 feet)
<b>045</b>	4.5 meters (14.8 feet)
<b>060</b>	6.0 meters (19.7 feet)
<b>065</b>	6.5 meters (21.3 feet)

**B: Connector and Cable Option**

<b>00</b>	Without stainless steel armor
<b>01</b>	With stainless steel armor, with FEP jacket
<b>02</b>	With stainless steel armor, without FEP jacket
<b>03</b>	Without stainless steel armor, with connector protector
<b>04</b>	With stainless steel armor, with FEP jacket, with connector protector
<b>05</b>	With stainless steel armor, without FEP jacket, with connector protector
<b>06</b>	FluidLoc cable without stainless steel armor
<b>07</b>	FluidLoc cable with stainless steel armor, with FEP jacket
<b>08</b>	FluidLoc cable with stainless steel armor, without FEP jacket
<b>09</b>	FluidLoc without stainless steel armor, with connector protector

<b>10</b>	FluidLoc cable with stainless steel armor, with FEP jacket, with connector protector		
<b>11</b>	FluidLoc cable with stainless steel armor, without FEP jacket, with connector protector	03200006	Silicone self-fusing tape. A 9.1 meter (10 yard) roll of silicone tape to protect connectors. It is easy to install and provides excellent electrical isolation and protection from the environment. It is not recommended for use inside the casing of the machine.
<b>C: Agency Approval Option</b>			
<b>00</b>	Not Required		
<b>05</b>	Multiple Approvals	40113-03	Connector Protector Kit for 3300 NSv probes and extension cables, including connector protectors and installation tools.
<b>Accessories</b>			
147357	3300 XL NSv Proximitor User Guide		
02120015	Bulk field wire. 1.0 mm <sup>2</sup> (18 AWG), 3 conductor, twisted, shielded cable with drain wire. Specify length in feet.		
138492-01	Replacement panel-mount mounting pad		
138493-01	Replacement DIN-mount mounting pad		
01609137	BNC (F) to banana plugs		
01609138	Proximitor Connector Test Pin wiring (two test pins to a BNC (F) connector)		
40971-04	50 Ω cable with two BNC (M) connectors. Use this cable in combination with adapter 01609137 and adapter 01609138 when checking performance of the transducer system from the Proximitor Sensor test pin holes.	03800001	Connector Protector Adapter. Allows connector protector installation tools manufactured prior to 1998 to be used with 75 Ω ClickLoc connectors.
04310310	3300 XL Proximitor Sensor Panel-mount Screws. Package includes one 6-32 UNC thread forming mounting screw (supplied standard with 3300 XL Proximitor Housings [3300 XL option]).	330153-05	Connector Protectors. Package contains 10 pairs of connector protectors.
			Male Connector Protector. Placed on the extension cable to connect to the female connector protector on the probe and provide environmental protection of connectors.
			Female Connector Protector. Placed on the probe lead to connect to the male connector protector on the extension cable and provide environmental protection of connectors. Also placed on the extension cable to slide over the Proximitor Sensor connection and protect it from the environment.
			3300 NSv Connector Kit. Used on 3300 NSv probes and extension cables. Contains one set of male and female ClickLoc connectors, sleeves and one strip of silicone tape.

163356	<p>Connector Crimp Tool Kit. Includes one set of 75 <math>\Omega</math> ClickLoc inserts and connector installation instructions. Supplied with carrying case.</p> <p>Notes: 1. 330980 Proximitor Sensor A: options 52 and 72 come without a mounting pad and should be ordered only as spares. Each Proximitor Sensor needs a mounting pad to ensure that it is properly isolated from the housing ground.</p>
--------	---

## Graphs and Figures

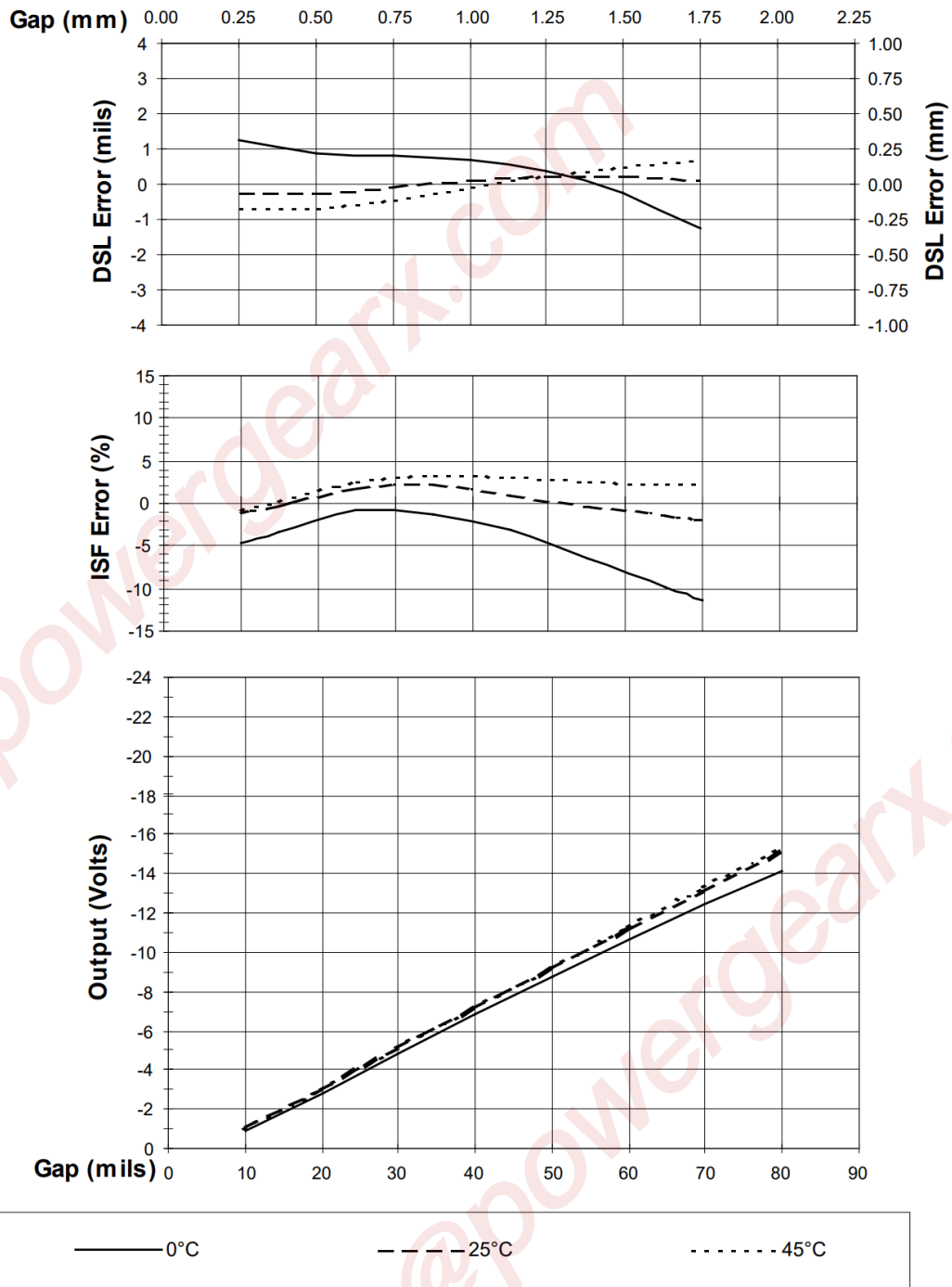


Figure 1: Typical 3300 XL NSv 5 m System over Ambient Temperature Range



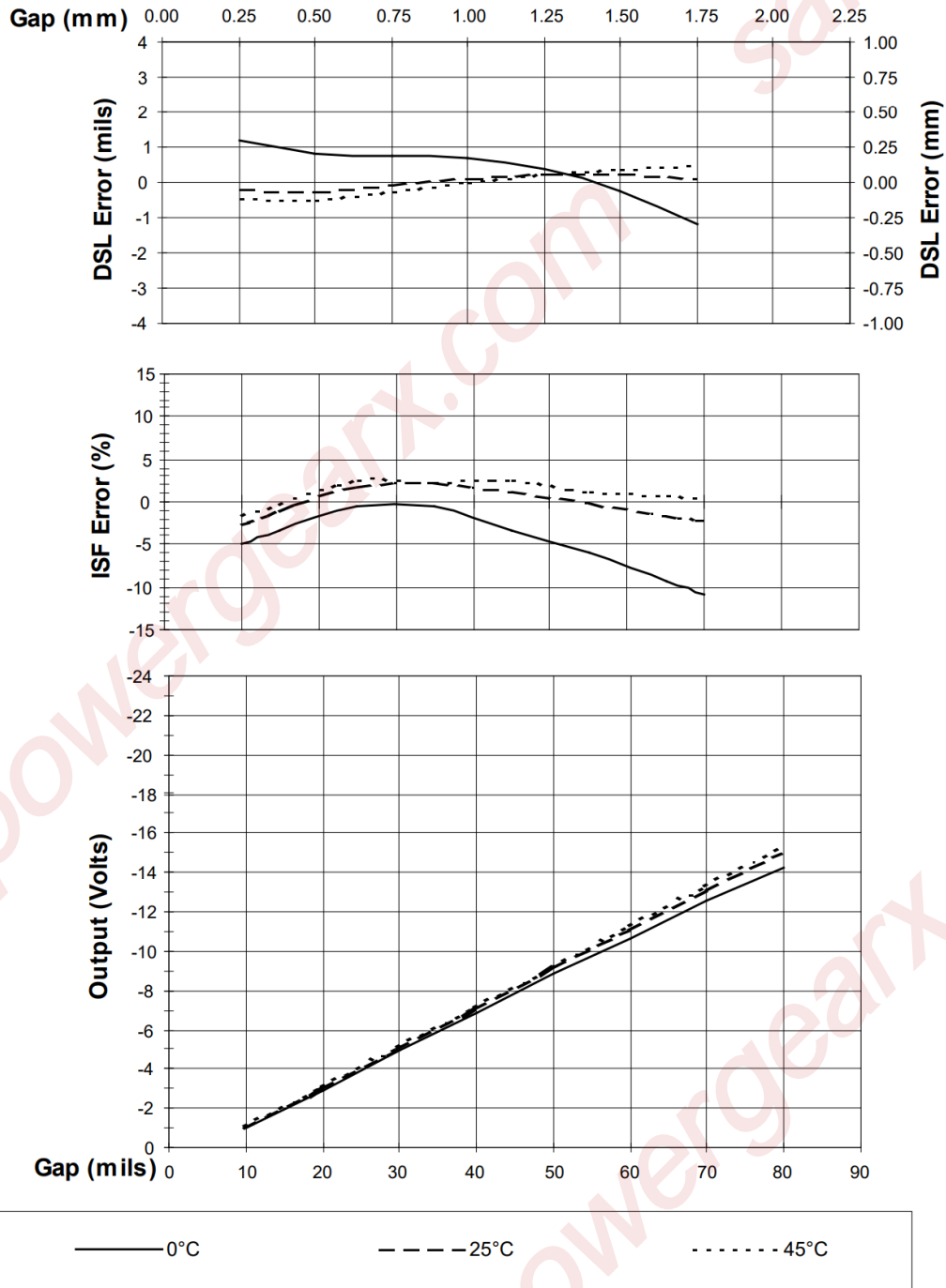
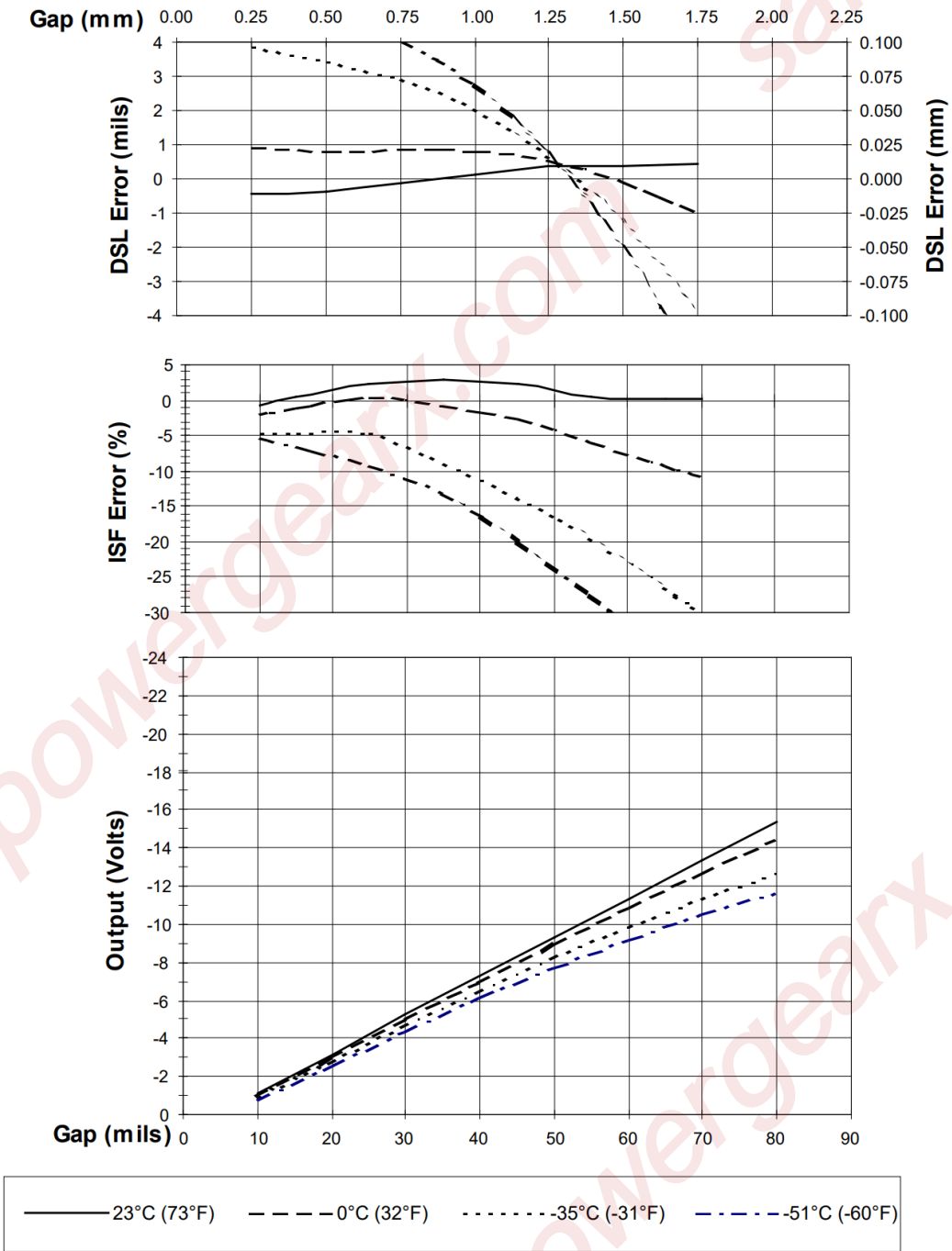
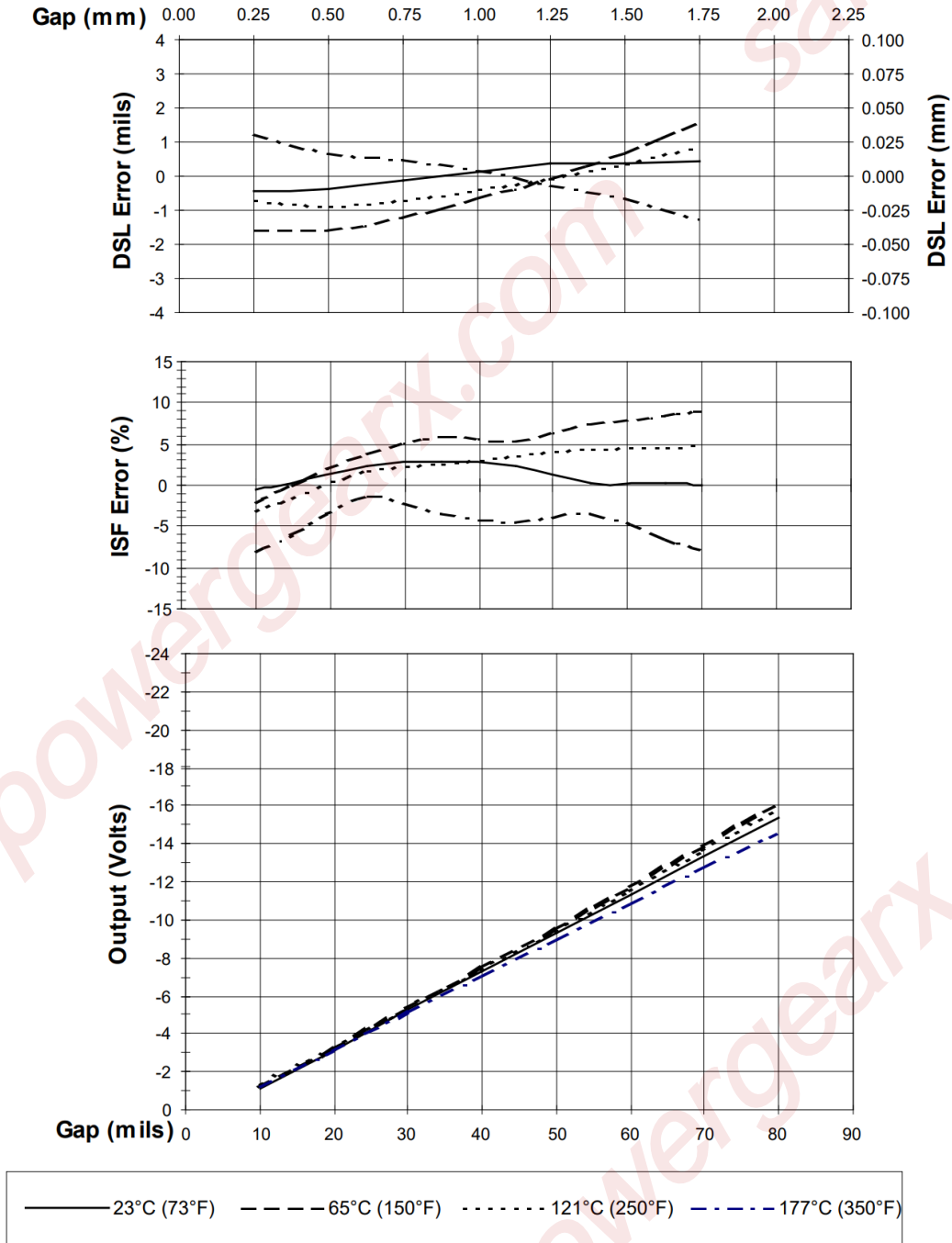


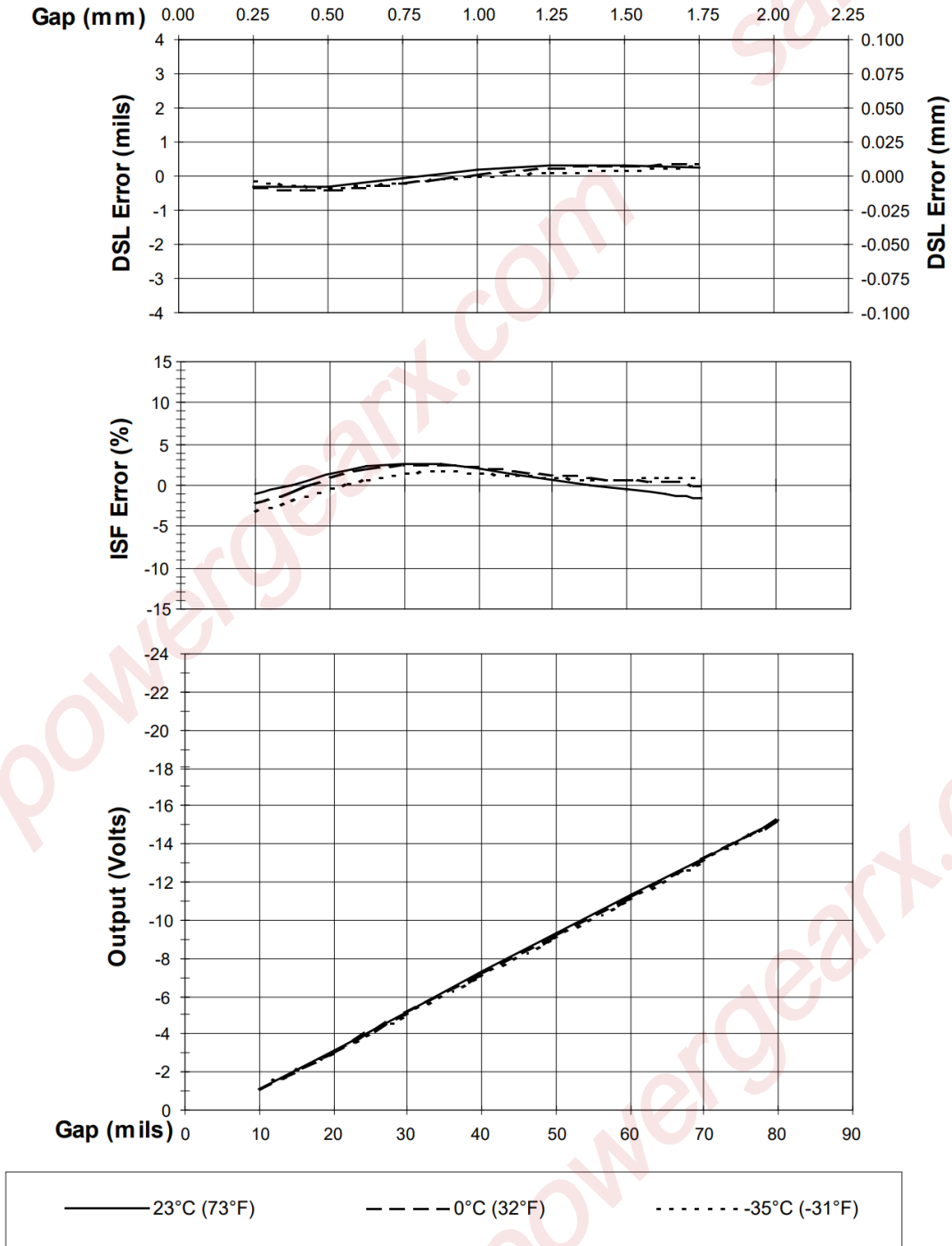
Figure 2: Typical 3300 XL NSv 7 m System over Ambient Temperature Range



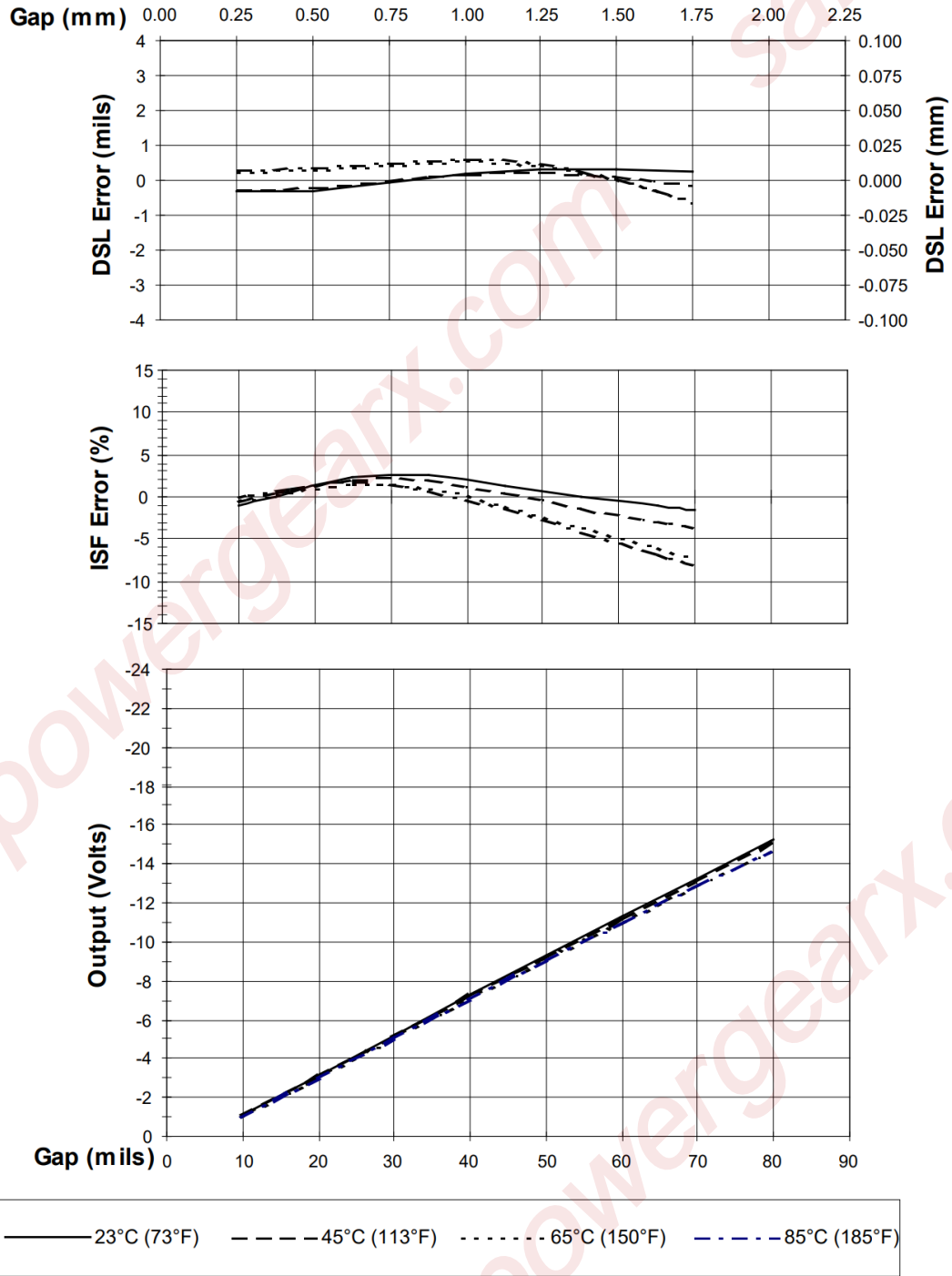
**Figure 3: Typical 3300 NSv Probe + 1m Cable @ Low Temperature (Proximitor Sensor + 4 m of Extension Cable @ 25°C)**



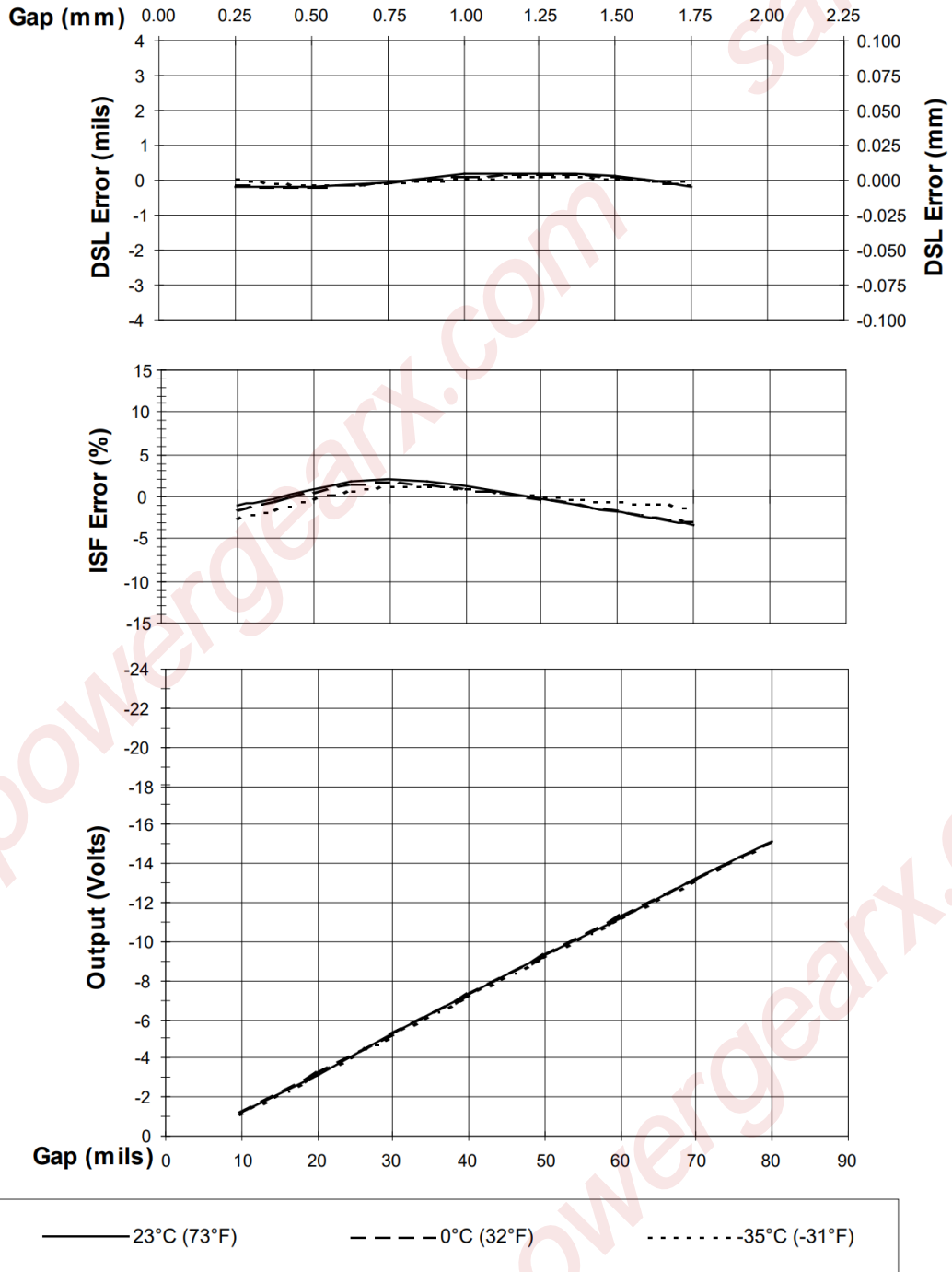
**Figure 4: Typical 3300 NSv Probe + 1 m Cable @ High Temperature (Proximitor Sensor + 4 m of Extension Cable @ 25°C)**



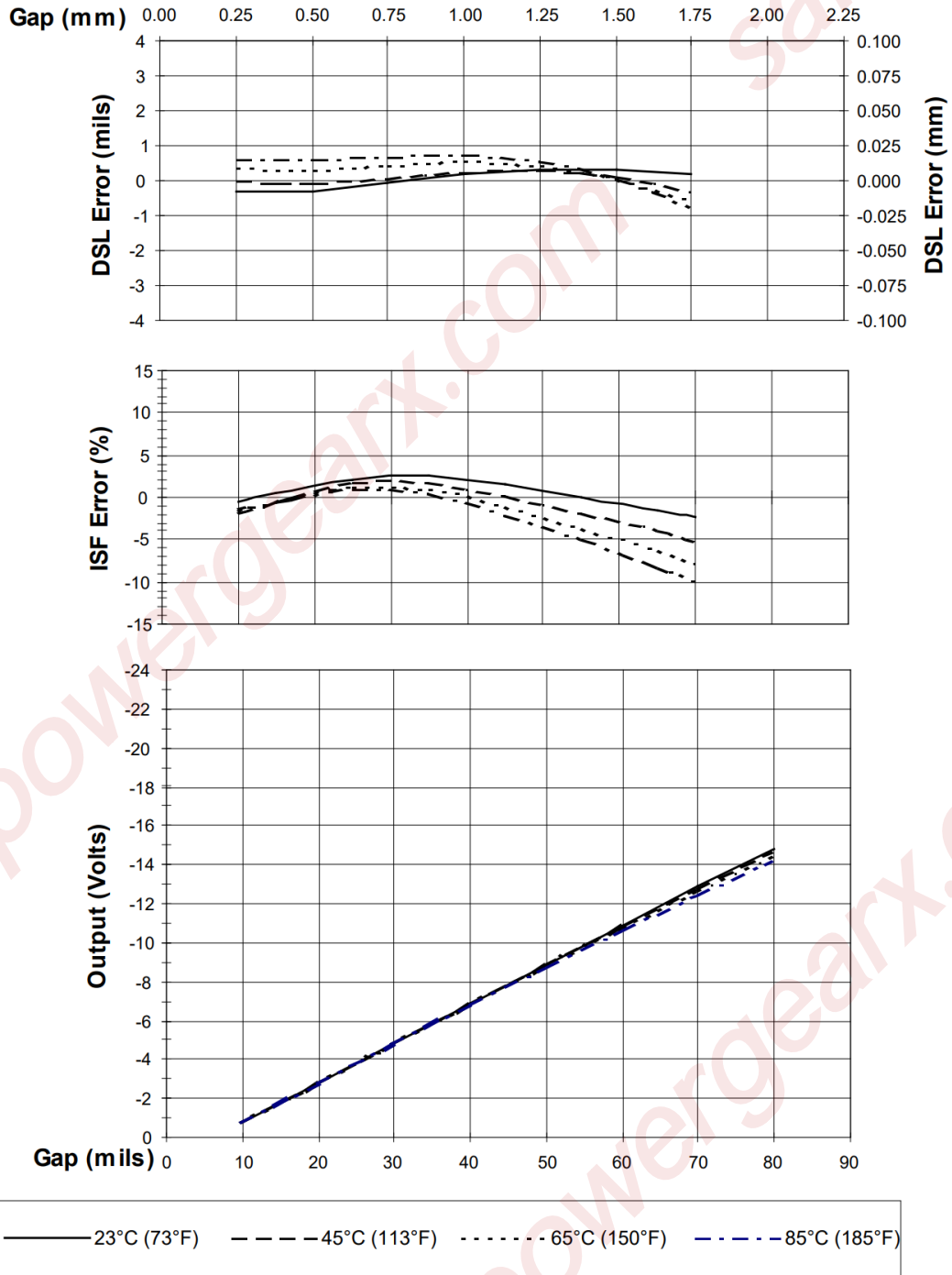
**Figure 5: Typical 3300 XL NSv 5 m Proximity Sensor with 4 m of Extension Cable @ Low Temperature (Probe is at 25°C)**



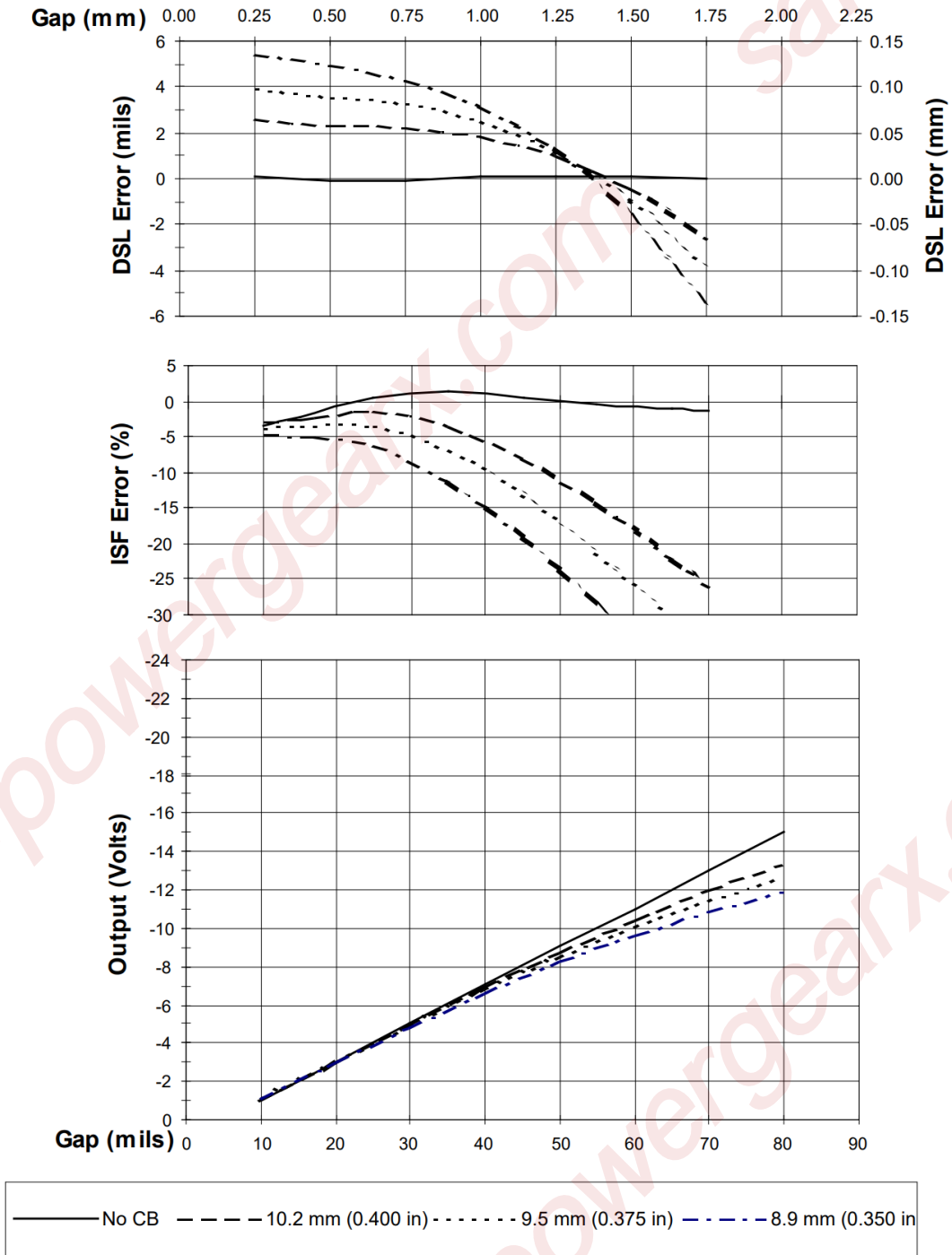
**Figure 6: Typical 3300 XL NSv 5 m Proximity Sensor with 4 m Extension Cable @ High Temperature (Probe is at 25°C)**



**Figure 7: Typical 3300 XL NSv 7 m Proximity Sensor with 6 m of Extension Cable @ Low Temperature (Probe is at 25°C)**

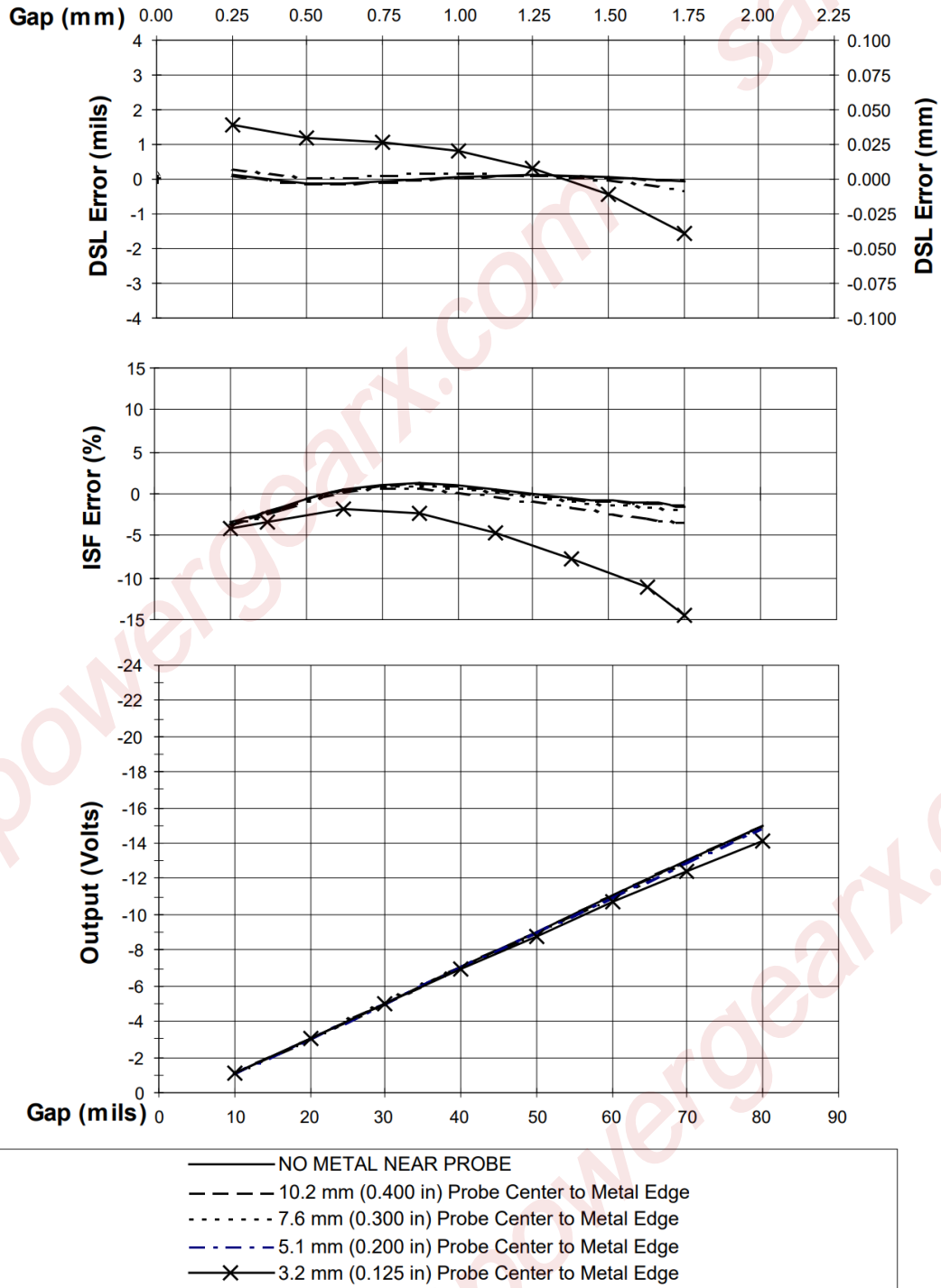


**Figure 8: Typical 3300 XL NSv 7 m Proximity Sensor with 6 m of Extension Cable @ High Temperature (Probe is at 25°C)**

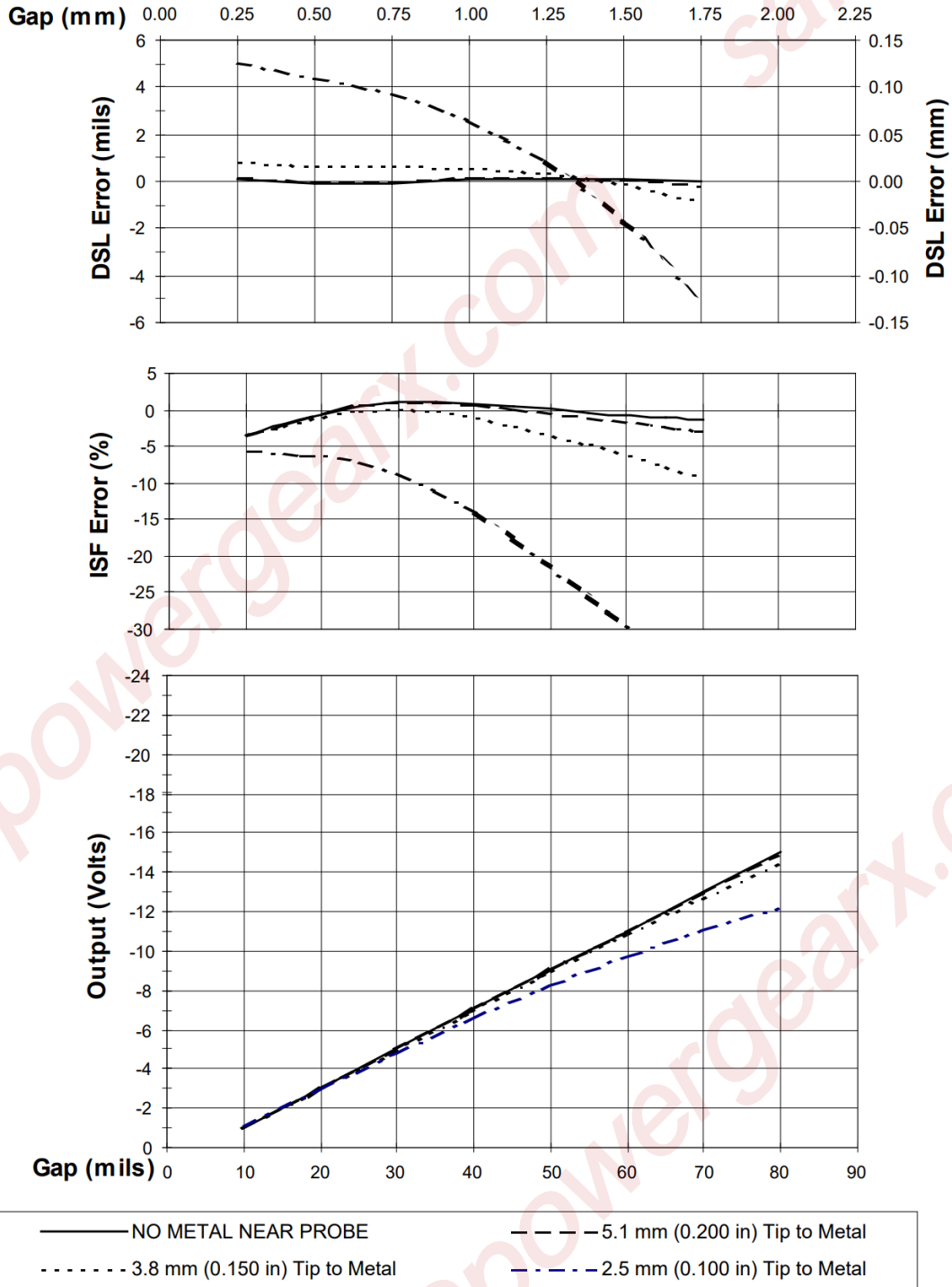


**Figure 9: Effect of Counterbore Side Clearance (4140 Material)**





**Figure 10: Effect of Flat Surface Side Clearance (4140 Material)**



**Figure 11: Effect of Rear Surface Clearance (4140 Material)**

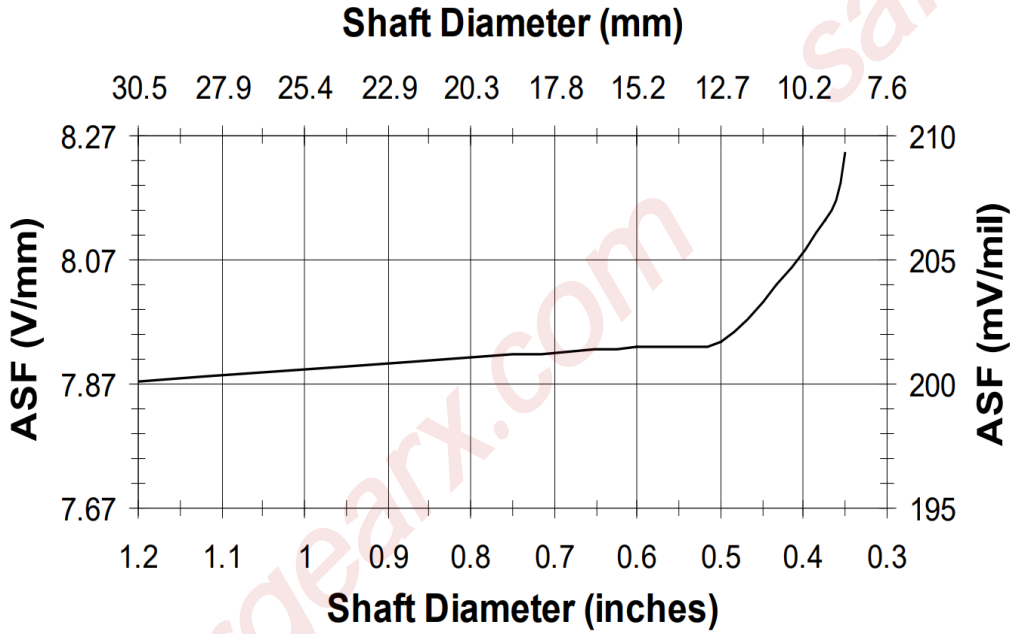


Figure 12: Axial Sensitivity to Shaft Size

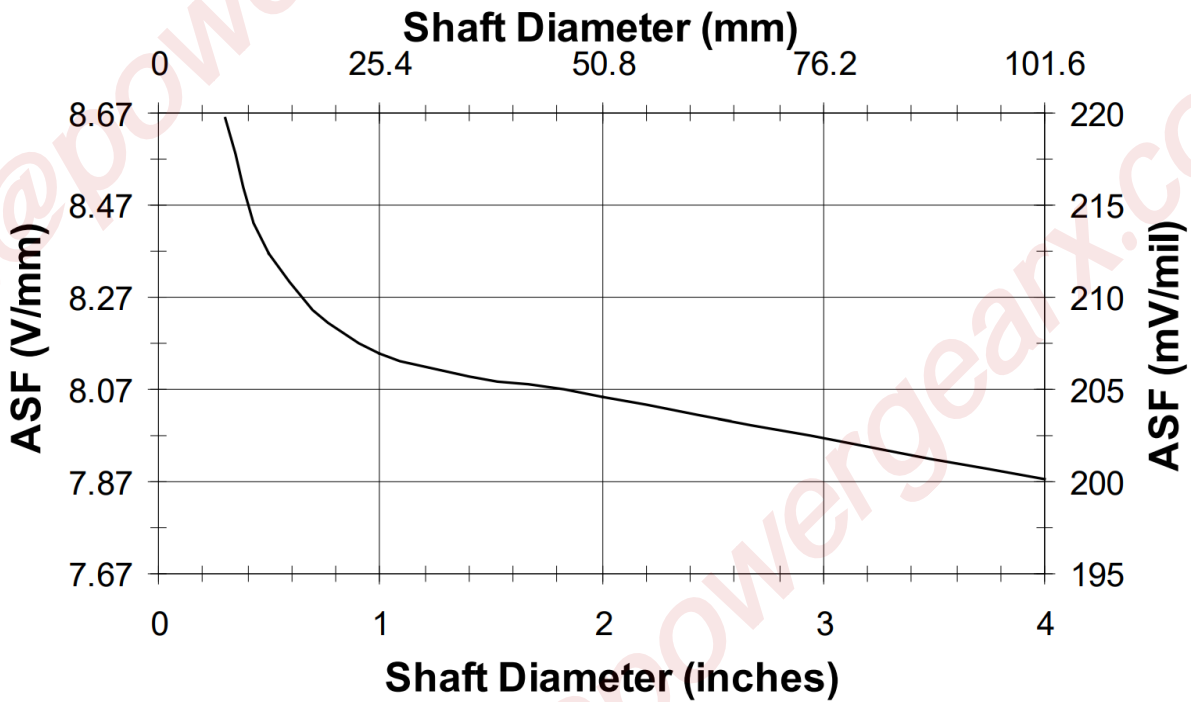


Figure 13: Radial Sensitivity to Shaft Size

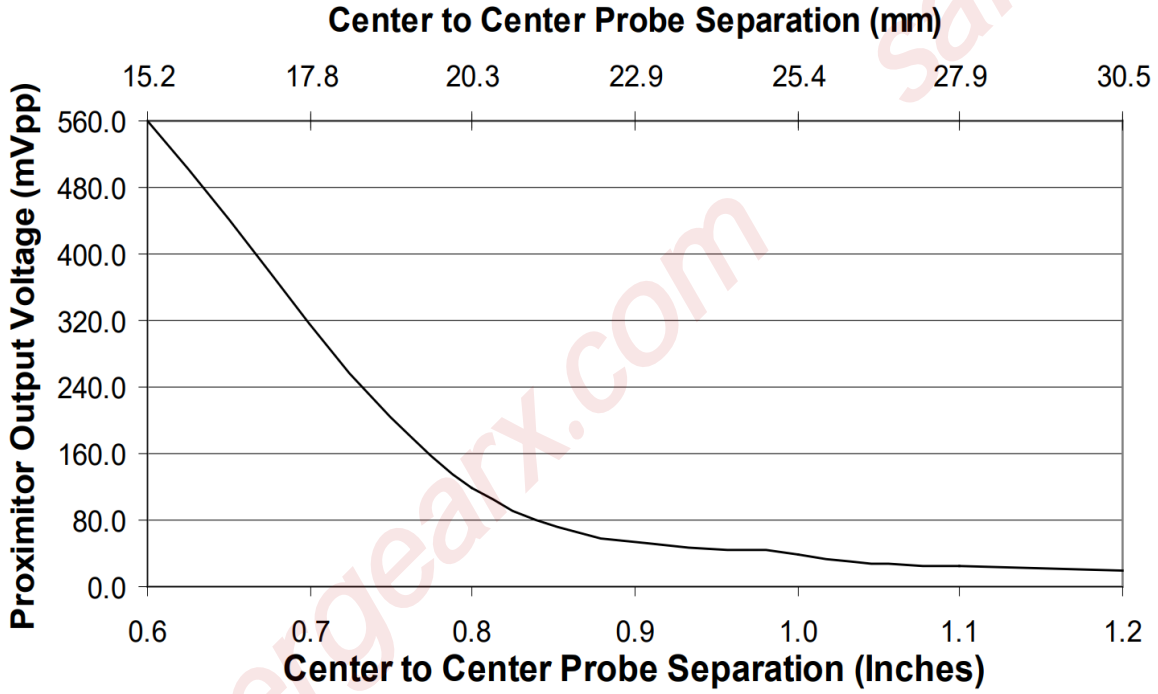


Figure 14: Probe Cross-talk with Probes Mounted in Parallel

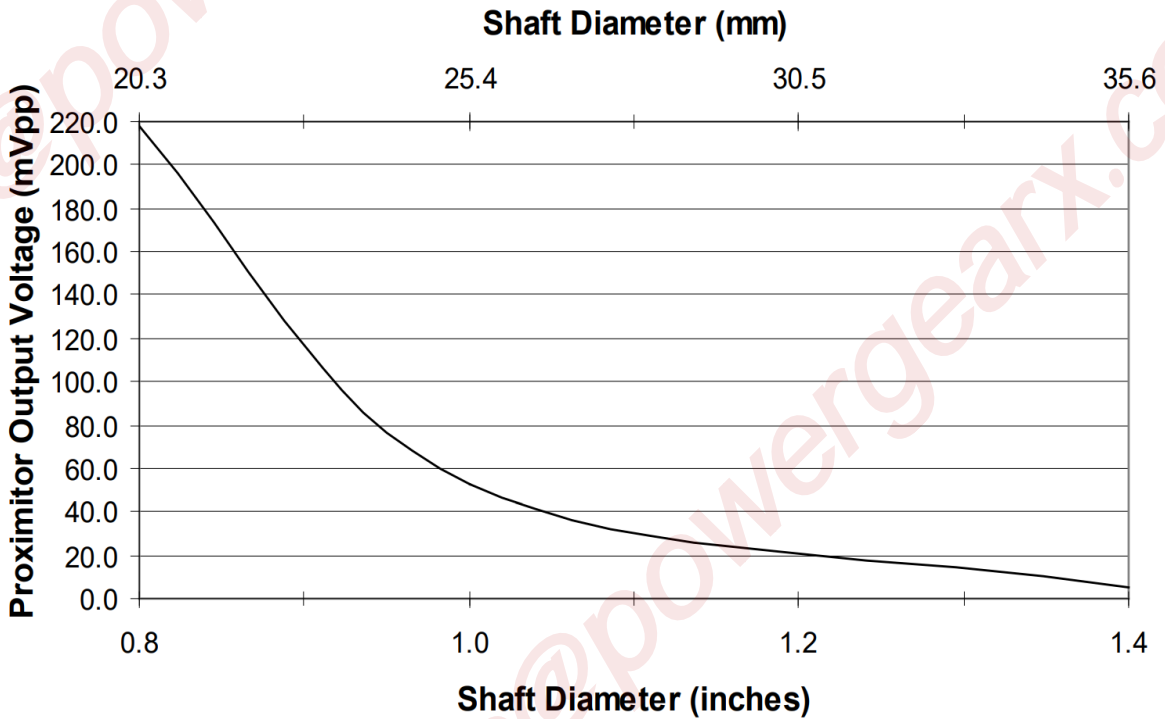
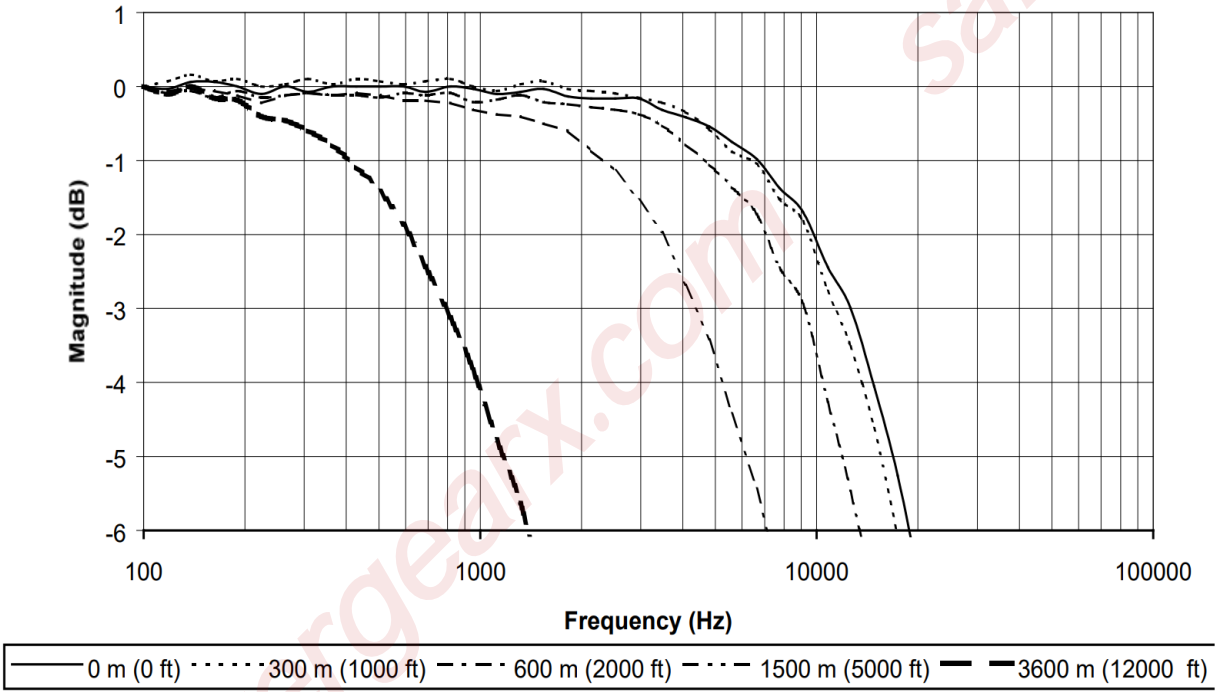
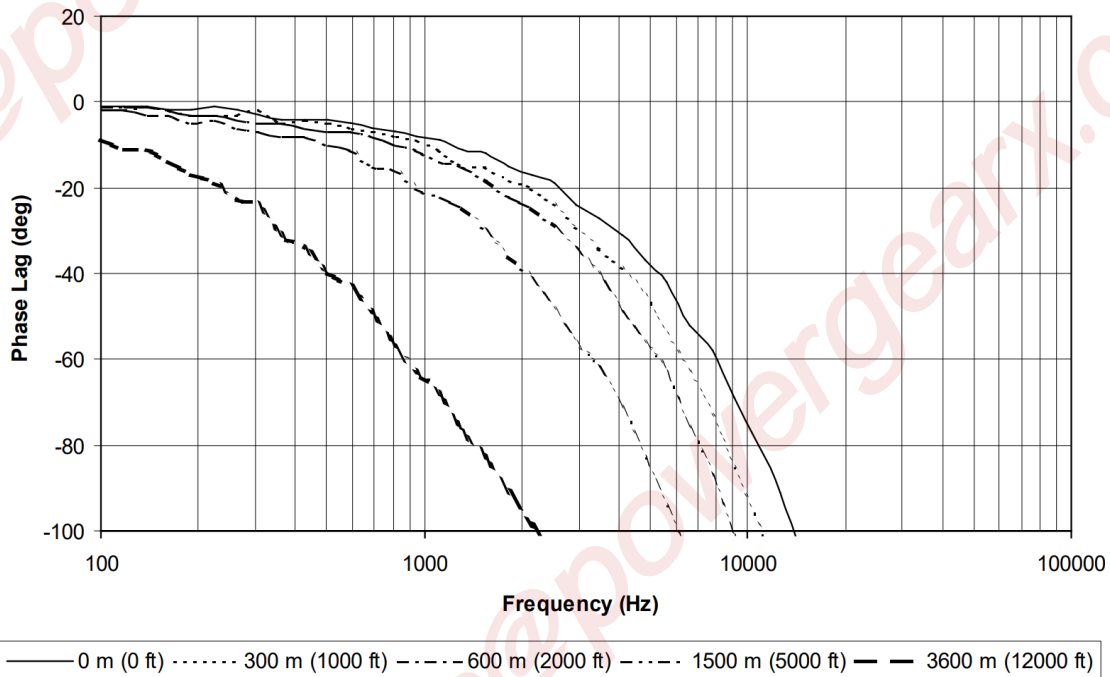


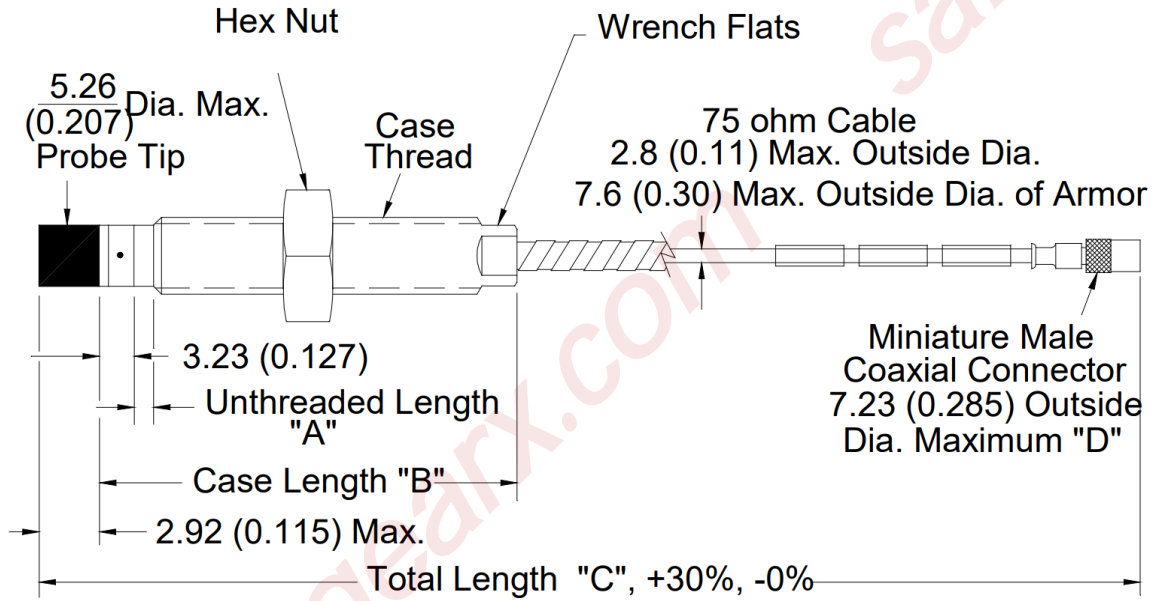
Figure 15: Probe Cross-talk with Probes Mounted in X-Y Configuration



**Figure 16: Frequency Response, magnitude of typical 3300 XL NSv System with various lengths of field wiring, no barriers**

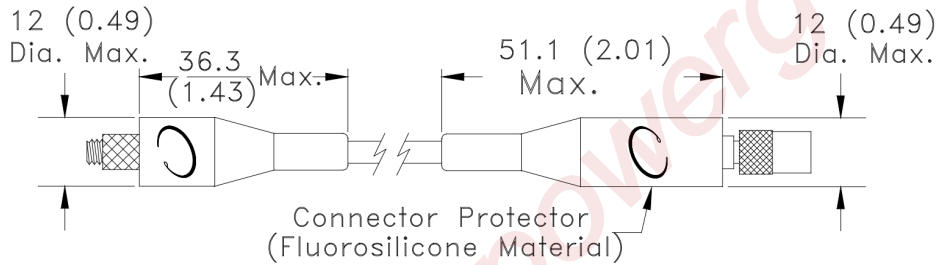


**Figure 17: Frequency Response, phase change of typical 3300 XL NSv System with various lengths of field wiring, no barriers**



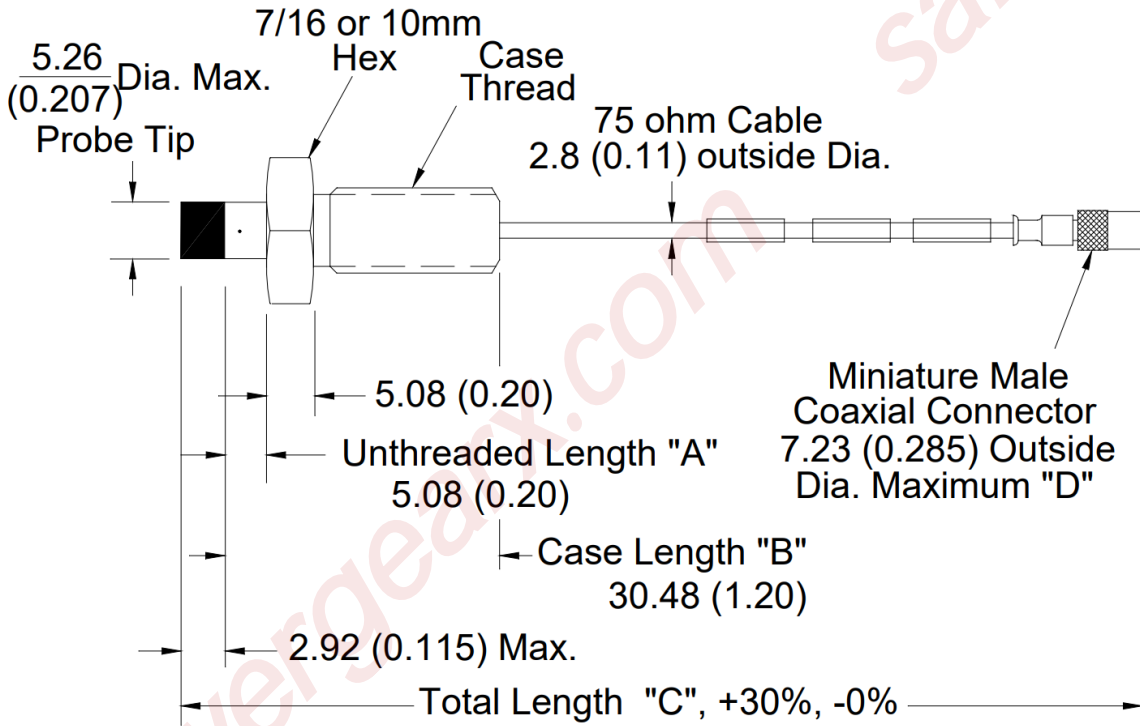
**Figure 18: 3300 NSv Proximity probes, Standard Mount**

- 330901, 1/4-28 UNF-2A, without armor
- 330902, 1/4-28 UNF-2A, with armor
- 330903, M8X1 thread, without armor
- 330904, M8X1 thread, with armor
- 330905, M10X1 thread, without armor
- 330908, 3/8-24 UNF-2A, without armor
- 330909, 3/8-24 UNF-2A, with armor
- 330910, M10X1 thread, with armor



Note: Connector Protector only installed on female end when optioned. Both ends available as accessories.

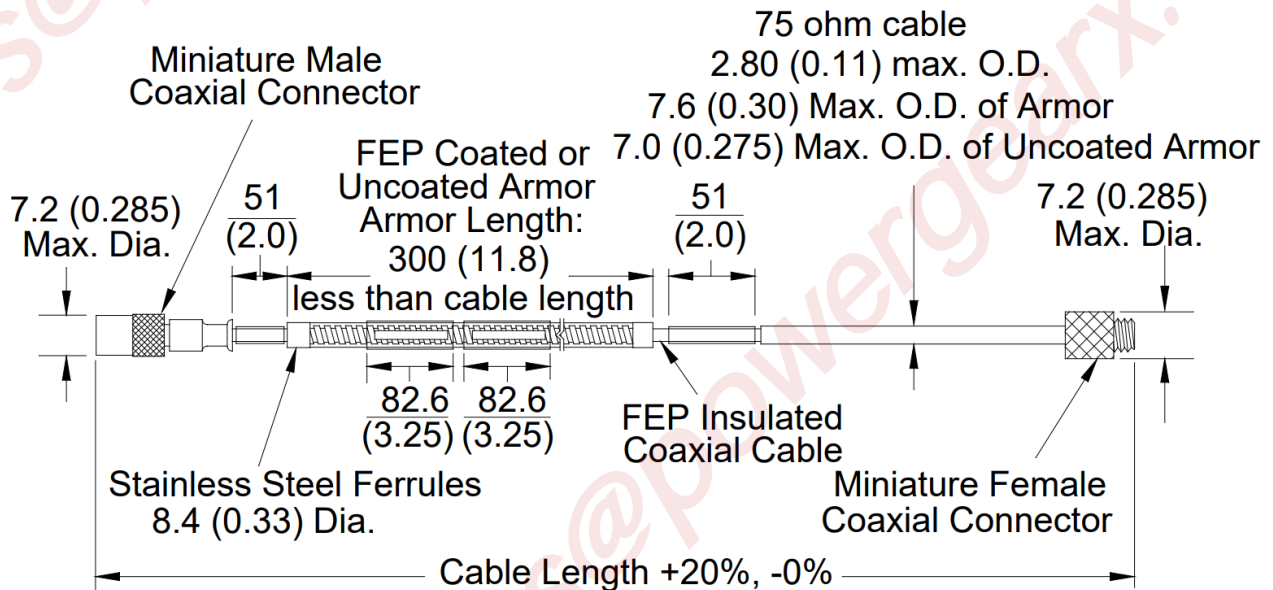
**Figure 19: Installed Connector Protectors**



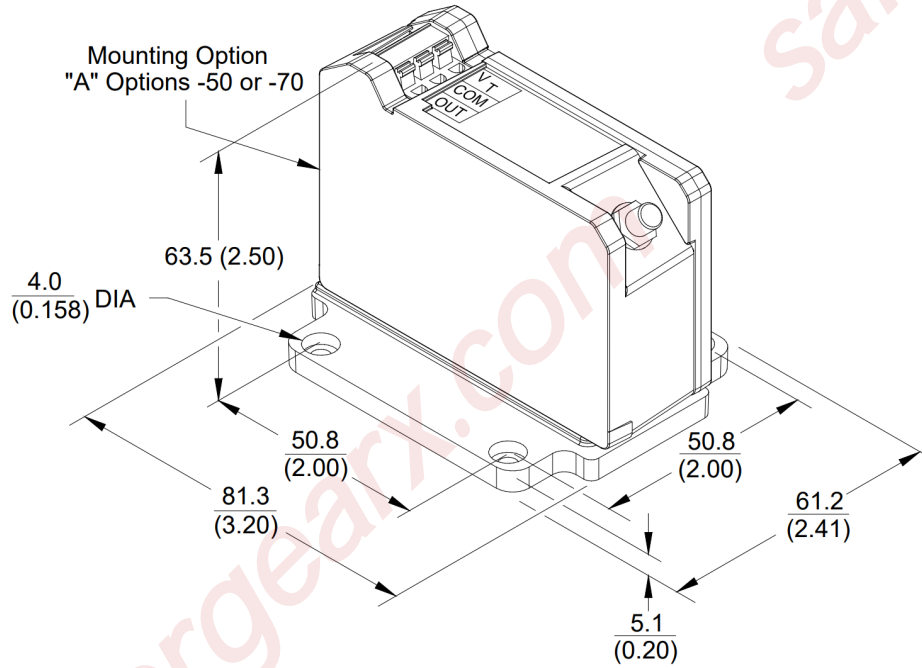
**Figure 20: 3300 NSv Proximity Probes, Reverse Mount**

330906, 3/8-24 UNF-2A threads

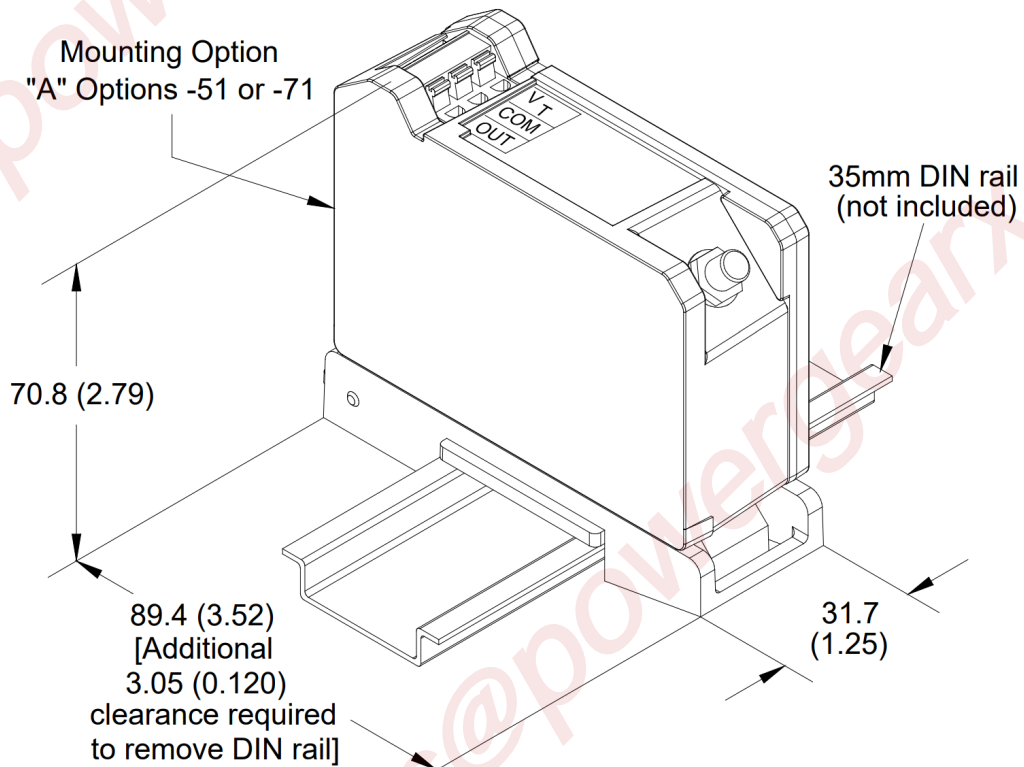
330907, M10X1 threads



**Figure 21: 330930, 3300 NSv Extension Cable**



**Figure 22: Panel Mount 3300 XL NSv Proximity Sensor**



**Figure 23: DIN Mount 3300 XL NSv Proximity Sensor**



**Notes:**

1. All dimensions on figures are in millimeters (inches) unless otherwise noted.
2. Standard mount 1/4 -28 UNF thread probes are supplied with 7/16 inch lock nut and 7/32 wrench flats.
3. Standard mount M8x1 thread probes are supplied with 13 mm lock nut and 7 mm wrench flats.
4. Standard mount 3/8-24 UNF thread probes are supplied with 9/16 inch lock nut and 5/16 wrench flats.
5. Standard mount M10X1 thread probes are supplied with 17 mm lock nut and 8 mm wrench flats.
6. Reverse mount probes are not available with armor or connector protector options.
7. Letters inside quotation marks on figures refer to probe ordering options.
8. Stainless steel armor is supplied with or without FEP outer jacket.
9. FEP jacket is standard on all non-armored probes.

Copyright 2024 Baker Hughes Company. All rights reserved.



Bently Nevada, Keyphasor, M2, Proximitor and Orbit Logo are registered trademarks of Bently Nevada, a Baker Hughes business, in the United States and other countries. The Baker Hughes logo is a trademark of Baker Hughes Company. All other product and company names are trademarks of their respective holders. Use of the trademarks does not imply any affiliation with or endorsement by the respective holders.

Baker Hughes provides this information on an "as is" basis for general information purposes. Baker Hughes does not make any representation as to the accuracy or completeness of the information and makes no warranties of any kind, specific, implied or oral, to the fullest extent permissible by law, including those of merchantability and fitness for a particular purpose or use. Baker Hughes hereby disclaims any and all liability for any direct, indirect, consequential or special damages, claims for lost profits, or third party claims arising from the use of the information, whether a claim is asserted in contract, tort, or otherwise. Baker Hughes reserves the right to make changes in specifications and features shown herein, or discontinue the product described at any time without notice or obligation. Contact your Baker Hughes representative for the most current information.

The information contained in this document is the property of Baker Hughes and its affiliates; and is subject to change without prior notice. It is being supplied as a service to our customers and may not be altered or its content repackaged without the express written consent of Baker Hughes. This product or associated products may be covered by one or more patents. See [Bentley.com/legal](https://www.bentley.com/legal).

1631 Bently Parkway South, Minden, Nevada USA 89423  
Phone: 1.775.782.3611 (US) or [Bentley.com/support](https://www.bentley.com/support)  
[Bentley.com](https://www.bentley.com)