

Operation and Maintenance Manual

Bently Nevada™ Asset Condition Monitoring

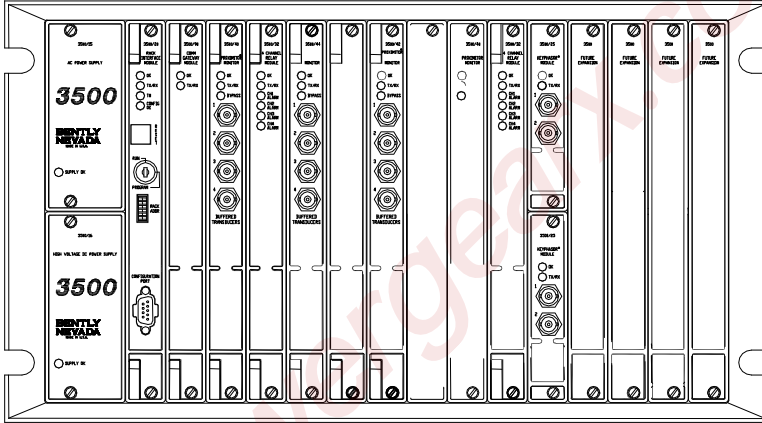

3500/42 Proximitors/Seismic Monitor Module

Copyright © 1995 Bently Nevada LLC
All rights reserved.

The information contained in this document is subject to change without notice.

The following are trademarks of General Electric Company in the United States and other countries:

Bently Nevada, Keyphasor and Proximitor

Contact Information

The following ways of contacting Bently Nevada are provided for those times when you cannot contact your local representative:

Mailing Address	1631 Bently Parkway South Minden, Nevada USA 89423 USA
Telephone	1.775.782.3611 1.800.227.5514
Fax	1.775.215.2873
Internet	www.ge-energy.com/bently

Additional Information

Notice:

This manual does not contain all the information required to operate and maintain the product. Refer to the following manuals for other required information.

**3500 Monitoring System Rack Installation and Maintenance Manual
(Part Number 129766-01)**

General description of a standard system.

General description of a Triple Modular redundant (TMR) system.

Instructions for installing the removing the module from a 3500 rack.

Drawings for all cables used in the 3500 Monitoring System.

**3500 Monitoring System Rack Configuration and Utilities Guide
(Part Number 129777-01)**

Guidelines for using the 3500 Rack Configuration software for setting the operating parameters of the module.

Guidelines for using the 3500 test utilities to verify that the input and output terminals on the module are operating properly.

**3500 Monitoring system Computer Hardware and Software Manual
(Part Number 128158-01)**

Instructions for connecting the rack to 3500 host computer.

Procedures for verifying communication.

Procedures for installing software.

Guidelines for using Data Acquisition / DDE Server and Operator Display Software.

Procedures and diagrams for setting up network and remote communications.

3500 Field Wiring Diagram Package (Part Number 130432-01)

Diagrams that show how to hook up a particular transducer.

Lists of recommended wiring.

Product Disposal Statement

Customers and third parties, who are not member states of the European Union, who are in control of the product at the end of its life or at the end of its use, are solely responsible for the proper disposal of the product. No person, firm, corporation, association or agency that is in control of product shall dispose of it in a manner that is in violation of any applicable federal, state, local or international law. Bently Nevada LLC is not responsible for the disposal of the product at the end of its life or at the end of its use.

Contents

1.	Receiving and Handling Instructions	1
	1.1 Receiving Inspection	1
	1.2 Handling and Storing Considerations	1
2.	General Information	2
	2.1 Triple Modular Redundant (TMR) Description	3
	2.2 Available Data	4
	2.2.1 Statuses	4
	2.2.2 Proportional Values	8
	2.3 LED Descriptions	9
3.	Configuration Information	10
	3.1 Software Configuration Options	10
	3.1.1 Proximator/Seismic Monitor Configuration Options	10
	3.1.2 Radial Vibration Channel Options	15
	3.1.3 Thrust Position Channel Options	27
	3.1.4 Differential Expansion Channel Options	37
	3.1.5 Eccentricity Channel Options	44
	3.1.6 Acceleration Channel Options	55
	3.1.7 Velocity Channel Options	66
	3.2 Setpoints	76
	3.3 Software Switches	80
4.	I/O Module Descriptions	83
	4.1 Setting the I/O Jumper	83
	4.2 Proximator/Seismic I/O Module (Internal Termination)	88
	4.3 Proximator/Seismic Internal Barrier I/O Module (Internal Termination)	89
	4.3.1 Wiring Euro Style Connectors	90
	4.4 External Termination I/O Modules	91
	4.4.1 Proximator/Seismic I/O Module (External Termination)	91
	4.4.2 Proximator/Seismic TMR I/O Module (External Termination)	92
	4.4.3 External Termination Blocks	93
	4.4.4 Cable Pin Outs	99
5.	Maintenance	101
	5.1 Verifying a 3500 Rack - Proximator®/Seismic Monitor Module	101

5.1.1	Choosing a Maintenance Interval	103
5.1.2	Required Test Equipment	103
5.1.3	Typical Verification Test Setup	105
5.1.4	Using the Rack Configuration Software	106
5.1.5	Radial Vibration Channels	110
5.1.6	Thrust Position and Differential Expansion Channels	143
5.1.7	Eccentricity Channels	156
5.1.8	Velocity Channels	170
5.1.9	Acceleration Channels	193
5.1.10	Verify Recorder Outputs	208
5.1.11	If a Channel Fails a Verification Test	209
5.2	Adjusting the Scale Factor and the Zero Position	210
5.2.1	Adjusting the Scale Factor	210
5.2.2	Zero Position Adjustment Description	211
5.2.3	Adjusting the Zero Position	217
6.	Troubleshooting	219
6.1	Self-test	219
6.2	LED Fault Conditions	220
6.3	System Event List Messages	221
6.4	Alarm Event List Messages	234
7.	Ordering Information	235
8.	Specifications	238

1. Receiving and Handling Instructions

1.1 Receiving Inspection

Visually inspect the module for obvious shipping damage. If shipping damage is apparent, file a claim with the carrier and submit a copy to Bently Nevada Corporation.

1.2 Handling and Storing Considerations

Circuit boards contain devices that are susceptible to damage when exposed to electrostatic charges. Damage caused by obvious mishandling of the board will void the warranty. To avoid damage, observe the following precautions in the order given:

Application Alert
Machinery protection will be lost when this module is removed from the rack.

- Do not discharge static electricity onto the circuit board. Avoid tools or procedures that would subject the circuit board to static damage. Some possible causes include ungrounded soldering irons, nonconductive plastics, and similar materials.
- Personnel must be grounded with a suitable grounding strap (such as 3M Velostat No. 2060) before handling or maintaining a printed circuit board.
- Transport and store circuit boards in electrically conductive bags or foil.
- Use extra caution during dry weather. Relative humidity less than 30 % tends to multiply the accumulation of static charges on any surface.

2. General Information

The 3500/42 Proximitor®/Seismic Monitor is a four channel monitor that accepts input from Proximitor and Seismic Transducers and uses this input to drive alarms. The monitor can be programmed using the 3500 Rack Configuration Software to perform any of the following functions: Radial Vibration, Thrust Position, Eccentricity, Differential Expansion, Acceleration, and Velocity. The monitor can receive input from many types of transducers including the following Bently Nevada transducers:

Proximitor Transducers	Acceleration	Velocity
7200 5, 8, 11, & 14 mm 3300 5, 8 mm, & 16 mm HTPS RAM 3000	Std. Accel Interface Module High Frequency Interface Module	9200, 47633, 86205 Velomitor High Temperature Velomitor

Front Panel

I/O Modules without Barriers

I/O Modules with Barriers

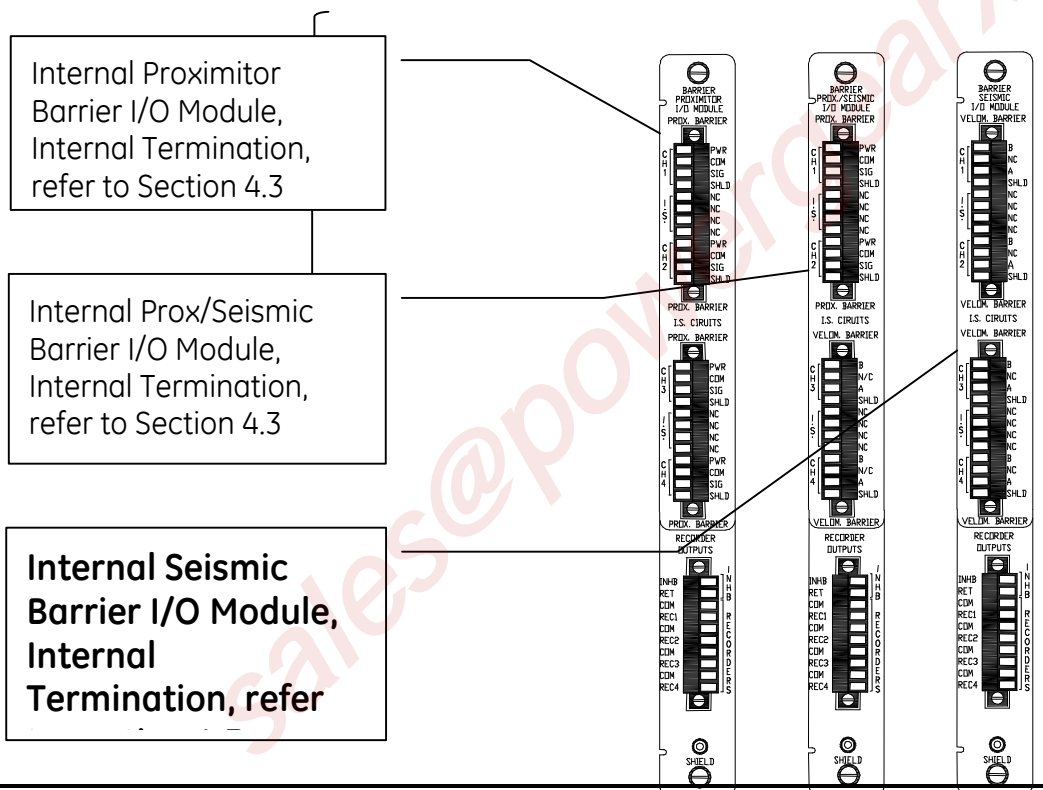

The primary purpose of the 3500/42 monitor is to provide 1) machinery protection by continuously comparing current machine vibration against configured alarm setpoints to drive alarms and, 2) essential machine vibration information to both operator and maintenance personnel. Alarm setpoints are configured using the 3500 Rack Configuration Software. Alarm setpoints can be configured for each active proportional value and danger setpoints can be configured for two of the active proportional values.

When shipped from the factory, the 3500/42 is delivered unconfigured. When needed, the 3500/42 can be installed into a 3500 rack and configured to perform the required monitoring function. This lets you stock a single monitor for use as a spare for many different applications.

2.1 Triple Modular Redundant (TMR) Description

When used in a TMR configuration, 3500/42 monitors and Proximity/Seismic TMR I/O Modules must be installed adjacent to each other in groups of three. When used in this configuration, two types of voting are employed to ensure accurate operation and to avoid single point failures.

The first level of voting occurs on the TMR Relay Module. With this voting, the selected alarm outputs for the three monitors are compared in a 2 out of 3 method. Two monitors must agree before the relay is driven. Refer to the 3500/32 & 34 Relay Module Operation and Maintenance Manual for more information on this voting.

The second type of voting is referred to as "Comparison" voting. With this type of voting, the proportional value outputs of each monitor in the group are compared with each other. If the output of one monitor differs from the output of the other monitors in the group by a specified amount, that monitor will add an entry to the System Event list. Configure comparison voting by setting Comparison and % Comparison in the Rack Configuration Software.

Comparison: The enabled proportional value of the TMR monitor group that is used to determine how far apart the values of the three monitors can be to each other before an entry is added to the System Event List.

% Comparison: The highest allowed percent difference between the middle value of the three monitors in a TMR group and the individual values of each monitor.

For TMR applications, two types of input configurations are available: bussed or discrete. Bussed configuration uses the signal from a single nonredundant transducer and provides that signal to all modules in the TMR group through a single 3500 Bussed External Termination Block.

Discrete configuration requires three redundant transducers at each measurement location on the machine. The input from each transducer is connected to separate 3500 External Termination Blocks.

2.2 Available Data

The Proximito/Seismic Monitor returns specific proportional values dependent upon the type of channel configured. This monitor also returns both monitor and channel statuses which are common to all types of channels.

2.2.1 Statuses

The following statuses are provided by the monitor. This section describes the available statuses and where they can be found.

Monitor Status

OK

This indicates if the monitor is functioning correctly. A not OK status is returned under any of the following conditions:

Module Hardware Failure

Node Voltage Failure

Configuration Failure

Transducer Failure

Slot ID Failure

Keyphasor Failure (if Keyphasor signals are assigned to channel pairs)

Channel not OK

If the Monitor OK status goes not OK, then the system OK Relay on the Rack Interface I/O Module will be driven not OK.

Alert/Alarm 1

This indicates whether the monitor has entered Alert/Alarm 1. A monitor will enter the Alert/Alarm 1 state when any proportional value provided by the monitor exceeds its configured Alert/Alarm 1 setpoint.

Danger/Alarm 2

This indicates whether the monitor has entered Danger/Alarm 2. A monitor will enter the Danger/Alarm 2 state when any proportional value provided by the monitor exceeds its configured Danger/Alarm 2 setpoint.

Bypass

This indicates when the monitor has bypassed alarming for one or more proportional values at a channel. When a channel bypass status is set, this monitor bypass status will also be set.

Configuration Fault

This indicates if the monitor configuration is valid.

Special Alarm Inhibit

This indicates whether all the nonprimary Alert/Alarm 1 alarms in the associated monitor channel are inhibited.

The Channel Special Alarm Inhibit function is active when:

- The Alarm Inhibit contact (INHB/RET) on the I/O Module is closed (active).
- A Channel Special Alarm Inhibit software switch is enabled.

Channel Status

OK

This indicates that no fault has been detected by the associated monitor channel.

There are three types of channel OK checking: Transducer Input Voltage, Transducer Supply Voltage, and Keyphasor OK. Keyphasor OK only affects channel pairs that have Keyphasor signals assigned to them. A channel OK status will be deactivated if any of the three OK types goes not OK.

Alert/Alarm 1

This indicates whether the associated monitor channel has entered Alert/Alarm 1. A channel will enter the Alert/Alarm 1 state when any proportional value provided by the channel exceeds its configured Alert/Alarm 1 setpoint.

Danger/Alarm 2

This indicates whether the associated monitor channel has entered Danger/Alarm 2. A channel will enter the Danger/Alarm 2 state when any proportional value provided by the channel exceeds its configured Danger/Alarm 2 setpoint.

Bypass

This indicates that the channel has bypassed alarming for one or more of its proportional values. A channel bypass status may result from the following conditions:

- A transducer is not OK, and the channel is configured for Timed OK Channel Defeat.

- The Keyphasor associated with the channel has gone invalid causing all proportional values related to the Keyphasor signal (for example 1X Amplitude, 1X Phase, Not 1X, ...) to be defeated and their associated alarms bypassed.
- The monitor has detected a serious internal fault.
- A software switch is bypassing any channel alarming function.
- The Special Alarm Inhibit is active and causing enabled alarms not to be processed.

Special Alarm Inhibit

This indicates whether all the nonprimary Alert/Alarm 1 alarms in the associated monitor channel are inhibited.

The Channel Special Alarm Inhibit function is active when:

- The Alarm Inhibit contact (INH/RET) on the I/O Module is closed (active).
- A Channel Special Alarm Inhibit software switch is enabled.

Off

This indicates whether the channel has been turned off. The monitor channels may be turned off (inactivated) using the Rack Configuration Software.

The following table shows where the statuses can be found:

Statuses	Communication Gateway Module	Rack Configuration Software	Operator Display Software
Monitor OK	X	X	
Monitor Alert/Alarm 1	X	X	
Monitor Danger/Alarm 2	X	X	
Monitor Bypass		X	
Monitor Configuration Fault		X	
Monitor Special Alarm Inhibit		X	
Channel OK	X	X	X
Channel Alert/Alarm 1	X	X	X
Channel Danger/Alarm 2	X	X	X
Channel Bypass	X	X	X
Channel Special Alarm Inhibit	X	X	X
Channel Off	X	X	

2.2.2 Proportional Values

Proportional values are vibration measurements used to monitor the machine. The Proximitors/Seismic Monitor returns the following proportional values:

Radial Vibration	Thrust Position	Differential Expansion
Direct *	Direct *	Direct *
Gap	Gap	Gap
1X Amplitude		
1X Phase Lag		
2X Amplitude		
2X Phase Lag		
Not 1X Amplitude		
S _{max} Amplitude		
Eccentricity	Acceleration	Velocity
Peak to Peak *	Direct *	Direct *
Gap		
Direct Min		
Direct Max		

* The primary value for the channel pair type. You can place these values into contiguous registers in the Communication Gateway or Display Interface Module.

2.3 LED Descriptions

The LED's on the front panel of the Proximator/Seismic Monitor indicate the operating status of the module as shown in the following figure. Refer to Section 6.2 (LED Fault Conditions) for all of the available LED conditions.

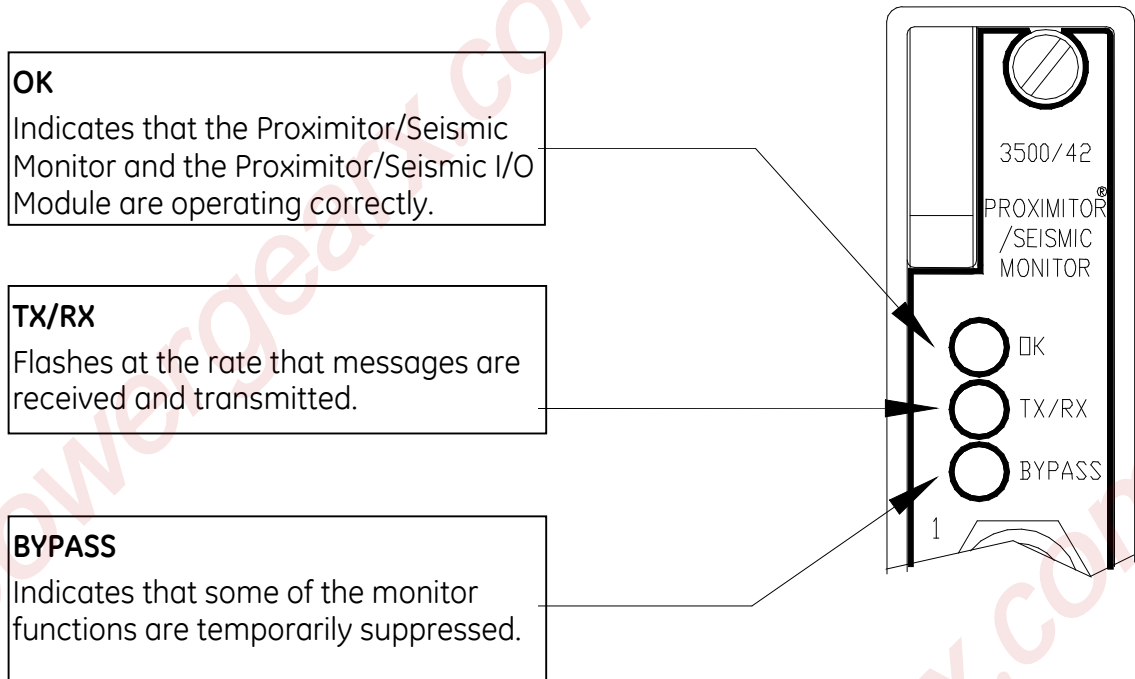

3. Configuration Information

This section describes how the 3500/42 Proximito®/Seismic Monitor is configured using the Rack Configuration Software. It also describes any configuration restrictions associated with this module. Refer to the 3500 Monitoring System Rack Configuration and Utilities Guide and the Rack Configuration Software for the details on how to operate the software.

3.1 Software Configuration Options

This section shows the configuration screens of the Rack Configuration Software that are associated with the monitor and discusses the configuration considerations. It will show a copy of the software screens and will explain the options that are available.

3.1.1 Proximito/Seismic Monitor Configuration Options

This section describes the options available on the Proximito/Seismic Monitor configuration screen.

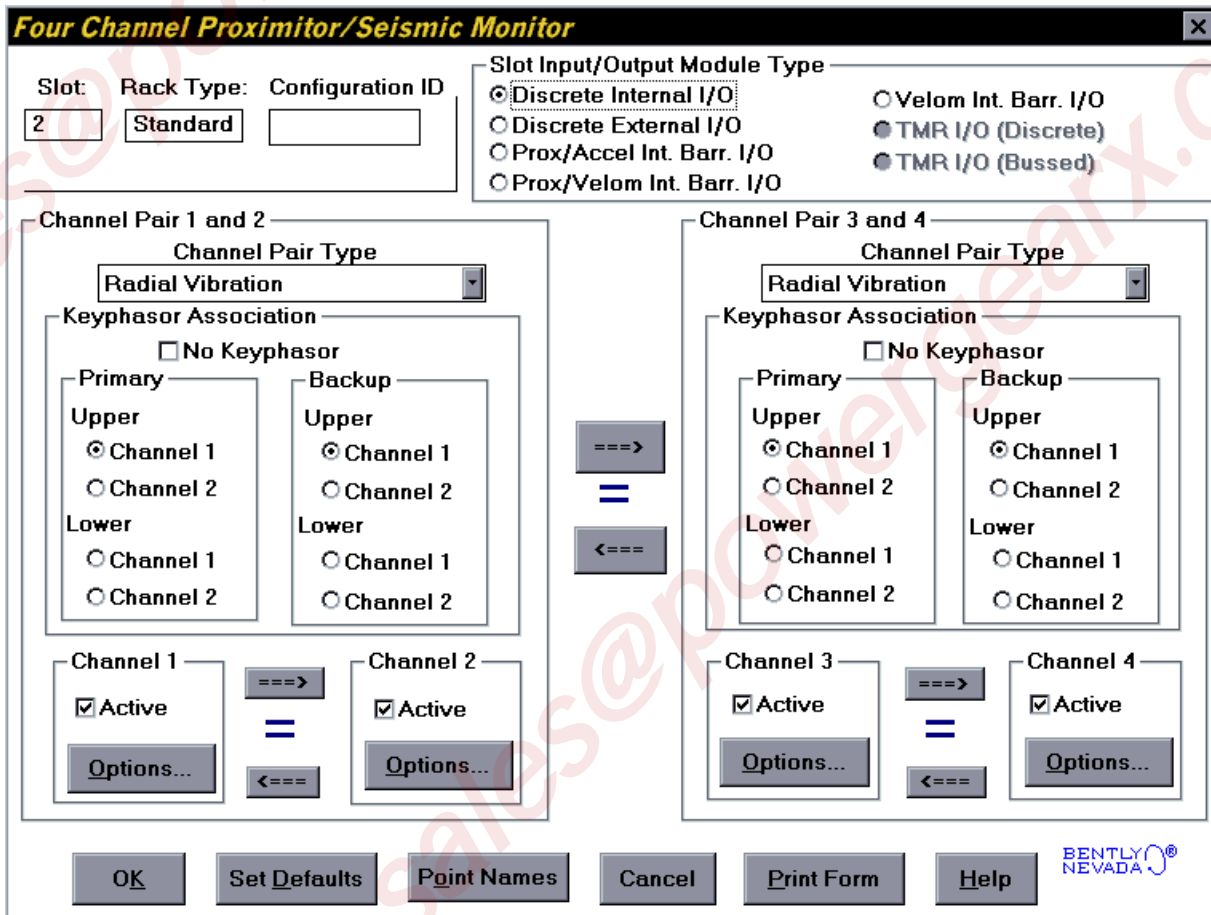

Reference Information

These fields contain information that indicates which module you are configuring.

Slot

The location of the monitor in the 3500 rack (2 through 15).

Rack Type

The type of Rack Interface Module installed in the rack (Standard or TMR).

Configuration ID

A unique six character identifier which is entered when a configuration is downloaded to the 3500 rack.

Slot Input/Output Module Type

The I/O field lets you identify the type of I/O Module that is attached to the monitor (The option selected must agree with the I/O module installed).

Discrete I/O

Used when each Proximator/Seismic Monitor and a Proximator/Seismic Discrete I/O Module are installed for a standard or nonredundant application.

Discrete Internal I/O

The transducer field wiring is connected directly to the I/O module.

Discrete External I/O

The transducer field wiring is connected to an External Termination Block and then routed from the External Termination Block to the I/O module through a 25-pin cable. The recorder field wiring is connected to an External Termination Block and then routed from the External Termination Block to the I/O module through a 9-pin cable.

Prox/Accel Internal Barrier I/O

The transducer field wiring is connected directly to the Proximitor/Seismic Monitor Internal Barrier I/O Module. Note that selecting the Prox/Accel Internal Barrier I/O option will disable certain transducer type options.

Prox/Velom Internal Barrier I/O

The transducer field wiring is connected directly to the Proximitor/Seismic Monitor Internal Barrier I/O Module. Note that selecting the Prox/Velom Internal Barrier I/O option will disable certain transducer type options.

Velom Internal Barrier I/O

The transducer field wiring is connected directly to the Proximitor/Seismic Monitor Internal Barrier I/O Module. Note that selecting the Velom Internal Barrier I/O option will disable certain transducer type options.

TMR I/O

Used when three identical adjacent monitors and three TMR I/O Modules are installed for a TMR application. Both the discrete and bussed configurations use the same external I/O modules but are wired differently as per the following paragraphs.

TMR I/O (Discrete)

This option is used when redundant transducers and field wiring are required. A set of twelve transducers are used to provide input signals to three identical adjacent monitors. Each transducer is connected to an External Termination Block and then routed to the Proximitor/Seismic TMR I/O Module using a 25-pin cable. The recorder field wiring is connected to an External Termination Block and then routed from the External Termination Block to the Proximitor/Seismic TMR I/O Module through a 9-pin cable.

TMR I/O (Bussed)

This option is used when redundant transducers and field wiring are not required. A single set of four transducers are sent to three identical adjacent monitors. Each transducer is connected to a Bussed External Termination Block and then the Bussed External Termination Block is connected to the Proximitor/Seismic TMR I/O Modules using three 25-pin

cables. The recorder field wiring is connected to an External Termination Block and then routed from the External Termination Block to the Proximator/Seismic TMR I/O Module through a 9-pin cable.

Channel Pair 1 and 2

Channel Pair 3 and 4

The fields within these boxes pertain to both channels of the channel pair.

Channel Pair Type

The type of monitoring which is to be performed by the channel pair. The following Channel Pair types are available in the monitor:

- Radial Vibration
- Thrust Position
- Differential Expansion
- Eccentricity
- Acceleration
- Velocity

Keyphasor® Association

No Keyphasor

Can be used when a Keyphasor is not available. If this is marked then the only data that will be available is Direct and Gap. This field will automatically be marked for channel pairs which do not require a Keyphasor transducer (for example Thrust Position and Differential Expansion).

Primary

The Keyphasor channel selected that is normally used for measurement. When this Keyphasor transducer is marked invalid, the backup Keyphasor transducer will provide the shaft reference information.

Backup

The Keyphasor channel selected that will be used if the primary Keyphasor fails. If you do not have a backup Keyphasor, select the same Keyphasor channel as the primary Keyphasor.

Note

For TMR applications, set Channel Pair 1 and 2 as primary Keyphasor and Channel Pair 3 and 4 as backup Keyphasor.

Active

Select whether the functions of the channel will be turned on () or off ().

Options

A button to display the configuration options for the selected channel type.

Notes:

The alarming hysteresis for all channel configurations for a 42 Monitor is 1/64 of Full Scale. When a channel exceeds an alarm setpoint, it must fall back below the setpoint less the hysteresis before it can go out of alarm. For example, consider a channel configuration with a 0–10 mils full scale and an alarm setpoint at 6 mils as illustrated below:

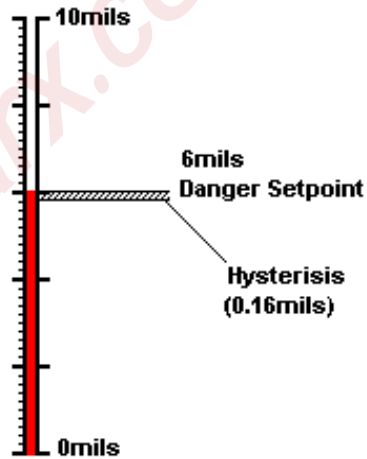

The hysteresis = 10 mils/64 = 0.16 mils. The channel input must fall below 6 mils - 0.16 mils (5.84 mils) before the channel is out of alarm.

3.1.2 Radial Vibration Channel Options

This section discusses the Configuration Considerations and the Rack Configuration Software screens associated with the Radial Vibration Channel.

3.1.2.1 Radial Vibration Channel Configuration Considerations

Consider the following items before configuring a Radial Vibration Channel:

- Internal Barrier I/O Modules and External barriers are not currently supported with 7200 11 mm or 14 mm, or 3000 Proximity sensors, or the 3300 16 mm HTPS.
- When "No Keyphasor" is selected, the 1X Amplitude (Ampl) and Phase Lag, 2X Amplitude (Ampl) and Phase Lag, Not 1X Amplitude (Ampl), and S_{max} Amplitude (Ampl) can not be selected.
- If a Keyphasor channel is selected, a Keyphasor Module must be installed in the rack.

- The full scale options allowed for each proportional value is dependent upon the transducer type.
- If a Non-Standard transducer is selected, the setpoint OK limits are set to ± 1 volt from the Upper and Lower OK limits that are selected.
- There are two selections for 3000 Series transducers:

3000(-24V) Proximitors

Select this option when connecting a 3000 Series proximitors directly to a 3500 monitor. A default scale factor of 285 mV/mil will be selected. This may be adjusted $\pm 15\%$. Note that the buffered transducers on the front of the monitors and to the Data Manager are not compensated and should be interpreted at 285 mV/mil.

3000(-18V) Proximitors

Select this option when connecting a 3000 Series proximitors directly to a 3500 monitor, but supplying proximitors power from an external 18 volt source. A default scale factor of 200 mV/mil will be selected. This may be adjusted $\pm 15\%$. Note that the buffered transducers on the front of the monitors and to the Data Manager are not compensated and should be interpreted at 200 mV/mil.

- Setpoints may only be set on proportional values which are enabled. Monitors must be configured in channel pairs (for example, Channels 1 and 2 may be configured as Radial Vibration and Channels 3 and 4 may be configured as Thrust Position).
- When a full-scale range is modified, the setpoints associated with this proportional value should be readjusted.
- It is best to set the Scale Factor value and the Trip Multiply value before the Zero Position value.
- 3000 (-18V), 3000 (-24V), and 3300 RAM Proximitors have limited linear ranges. Therefore, you should use caution when selecting the Full-scale range of the Direct, 1X Amplitude (Ampl), 2X Amplitude (Ampl), Not 1X Amplitude (Ampl) and S_{max} Amplitude (Ampl) PPLs. Full-scale value x Trip Multiply should not exceed the linear range of the transducer.

3.1.2.2 Radial Vibration Channel Configuration Options

This section describes the options available on the Radial Vibration Channel

Radial Vibration Channel Options

Channel: (Active) Slot: Rack Type:

Enable

	Full-scale Range	Clamp Value
Direct	0-10 mil pp	0.00
Gap	-24 Vdc	0.0
<input checked="" type="checkbox"/> 1X Ampl	0-10 mil pp	0.00
1X Phase Lag		0
<input checked="" type="checkbox"/> 2X Ampl	0-10 mil pp	0.00
2X Phase Lag		0
<input checked="" type="checkbox"/> Not 1X Ampl	0-10 mil pp	0.00
<input checked="" type="checkbox"/> Smax Ampl	0-10 mil	0.00

Zero Position (Gap) Volts

Trip Multiply 1.00 to 3.00 (steps of 0.25)

Direct Frequency Response cpm

Transducer Selection

Type

Transducer Jumper Status (on I/O Module):

Recorder Output Two mA Clamp

Delay

Alert	Danger
<input type="text" value="3"/> 1 - 60 s	<input type="text" value="1.0"/> 1.0 - 60.0 s <input type="checkbox"/> 100 ms

Alarm Mode

Alert

Latching Nonlatching

Danger

Latching Nonlatching

Transducer Orientation

Degrees Left Right

Barriers

None Internal
 MTL 796(-) Zener Ext.
 Galvanic Isolator

configuration screen.

Timed OK Channel Defeat

This prevents a channel from returning to an OK status until that channel's transducer has remained in an OK state for 30 seconds. This feature is always enabled in the Radial Vibration Channels. The option protects against false trips caused by intermittent transducers.

CP Mod

Selecting the CP Mod button Channel Options Dialog Box, allows a Custom channel configuration to be downloaded to the monitor. Custom configuration data is stored in a Custom Products Modification File. Custom Products Modification files follow the naming convention <modification #.mod>. These files must be located in the \3500\Rackcfg\Mods\ directory. When a CP Mod file is selected, a window is displayed which describes the function of the modification.

CP Mod files are available through Bently Nevada's Custom Products Division. Contact your local Bently Nevada Sales Representative for details.

Reference Information

These fields contain information that indicates which module you are configuring.

Channel

The number of the channel being configured (1 through 4).

Slot

The location of the monitor in the 3500 rack (2 through 15).

Rack Type

Identifies the type of Rack Interface Module installed in the rack (Standard or TMR).

Enable

An enabled proportional value specifies that the value will be provided by the channel (enabled, disabled).

Direct

Data which represents the overall peak to peak vibration. All frequencies within the selected Direct Frequency Response are included in this proportional value.

Gap

The physical distance between the face of a proximity probe tip and the observed surface. The distance can be expressed in terms of displacement (mils, micrometres) or in terms of voltage. Standard polarity convention dictates that a decreasing gap results in an increasing (less negative) output signal.

1X Ampl

In a complex vibration signal, notation for the amplitude component that occurs at the rotative speed frequency.

1X Phase Lag

In a complex vibration signal, notation for the phase lag component that occurs at the rotative speed frequency.

2X Ampl

In a complex vibration signal, notation for the amplitude component having a frequency equal to two times the shaft rotative speed.

2X Phase Lag

In a complex vibration signal, notation for the phase lag component having a frequency equal to two times the shaft rotative speed. 2X phase lag is the angular measurement from the leading or trailing edge of the Keyphasor pulse to the following positive peak of the 2X vibration signal.

Not 1X Ampl

In a complex vibration signal, notation for the amplitude component that occurs at frequencies other than rotative speed.

S_{max} Ampl

Single peak measurement of unfiltered XY (orthogonal) probes, in the measurement planes, against a calculated "quasi zero" point. Only one S_{max} Ampl value is returned per channel pair (channel 1 or channel 3).

Full Scale Range

Each selectable proportional value provides the ability to set a full scale value. If the desired full scale value is not in the pull down list, then the custom selection can be chosen.

The values in the following table are the same for all transducer types.

Direct
1X Ampl
2X Ampl
Not 1X Ampl
S_{max} Ampl

0-3 mil pp
0-5 mil pp
0-10 mil pp
0-15 mil pp
0-20 mil pp
0-100 µm pp

- 0-150 μm pp
- 0-200 μm pp
- 0-400 μm pp
- 0-500 μm pp
- Custom

Gap Full Scale Ranges by transducer type		
3300-5 mm Proximitor	7200-11 mm Proximitor	3000 (-18V) Proximitor
3300-8 mm Proximitor	7200-14 mm Proximitor	3000 (-24V) Proximitor
7200-5 mm Proximitor	3300-16 mm HTPS	3300 RAM Proximitor
7200-8 mm Proximitor	Nonstandard	
-24 Vdc	-24 Vdc	-24 Vdc
15-0-15 mil	15-0-15 mil	15-0-15 mil
25-0-25 mil	25-0-25 mil	300-0-300 μm
300-0-300 μm	50-0-50 mil	
600-0-600 μm	300-0-300 μm	
Custom	600-0-600 μm	
	1000-0-1000 μm	
	Custom	

Clamp Value

The value that a proportional value goes to when that channel or proportional value is bypassed or defeated (For example when a problem occurs with the transducer). The selected value can be between the minimum and maximum full-scale range values. (1X and 2X Phase Lag have available values of 0 to 359 degrees.) Only the values available from the Recorder Outputs, Communication Gateway and Display Interface Module are clamped to the specified value when the proportional value is invalid.

Recorder Output

The proportional value of a channel that is sent to the 4 to 20 mA recorder. The recorder output is proportional to the measured value over the channel full scale range. An increase in the proportional value that would be indicated as upscale on a bar graph display results in an increase in the current at the recorder output.

If 1X Phase Lag or 2X Phase Lag are selected then the two options available are with and without Hysteresis. If the channel is Bypassed, the output will be clamped to the selected clamp value or to 2 mA (if the 2 mA

clamp is selected).

The Hysteresis option helps prevent the Recorder Output from jumping from Full to Bottom Scale when the phase measurement is near 0 or 359 degrees. When the Hysteresis option is checked, the recorder signal operates as follows:

- The recorder output is scaled such that 4 mA corresponds to 0 degrees and 20 mA corresponds to 380 degrees (360 plus 20 degrees).
- The transition of a phase measurement that is increasing does not occur until the measurement has gone 20 degrees past 360 degrees. At this point, the recorder signal switches from 20 mA to a signal that corresponds to 20 degrees or 4.842 mA.
- The transition of a phase measurement that is decreasing occurs at 0 degrees (4 mA). At this point, the recorder signal switches from 4 mA to a signal that corresponds to 360 degrees or 19.158 mA.

Delay

The time which a proportional value must remain at or above an over alarm level or below an under alarm level before an alarm is declared as active.

Alert

First level alarm that occurs when the transducer signal level exceeds the selected Alert/Alarm 1 setpoint. This setpoint can be set on the Setpoint screen. The Alert time delay is always set at one second intervals (from 1 to 60) for all available proportional values.

Danger

Second level alarm that occurs when the transducer signal level exceeds the selected Danger/Alarm 2 setpoint. This setpoint can be set on the Setpoint screen.

100 ms option

The 100 ms (typical) option applies to the Danger time delay only and has the following results:

If the 100 ms option is off (

- The Danger time delay can be set at one second intervals (from 1 to 60).

- The Danger time delay can be set for up to two available proportional values.

If the 100 ms option is on (

- The Danger time delay is set to 100 ms.
- The Danger time delay can only be set for the primary proportional value.

Zero Position (Gap)

Represents the zero position (in volts) when the gap scale is to read the engineering units of displacement. To ensure maximum amount of zero adjustment, the probe should be gapped as close as possible to the center gap voltage specified in the OK Limit table. This field is not available for Voltage Gap Scale.

Adjust Button

Adjust the Zero Position voltage. When this button is clicked, a utility starts that helps you set the gap zero position voltage. Since this utility provides active feedback from the 3500 rack, a connection with the rack is required. Refer to Section 5.2 (Adjusting the Scale Factor and the Zero Position).

Trip Multiply

The value selected to temporarily increase the alarm (Alert and Danger) setpoint values. This value is normally applied by manual (operator) action during startup to allow a machine to pass through high vibration speed ranges without monitor alarm indications. Such high vibration speed ranges may include system resonances and other normal transient vibrations.

Direct Frequency Response

The upper and lower corners for the band-pass filter used with direct vibration measurements. The available ranges are 240 to 240,000 cpm and 60 to 36,000 cpm.

Transducer Selection

The following transducer types are available for the Radial Vibration Channel (non-barrier I/O module):

- 3300 – 5 mm Proximitor
- 3300 – 8 mm Proximitor
- 7200 – 5 mm Proximitor
- 7200 – 8 mm Proximitor
- 7200 – 11 mm Proximitor
- 7200 – 14 mm Proximitor
- 3000 (-18 V) Proximitor
- 3000 (-24 V) Proximitor
- 3300 RAM Proximitor
- 3300 – 16 mm HTPS
- Nonstandard

The following transducer types are available for the Radial Vibration Channel (barrier I/O module):

- 3300 – 5 mm Proximitor
- 3300 – 8 mm Proximitor
- 7200 – 5 mm Proximitor
- 7200 – 8 mm Proximitor
- 3300 RAM Proximitor
- Nonstandard

Customize button

Used to adjust the Scale Factor for transducers. If Non-standard is selected as the transducer type, the OK Limits can also be adjusted. The Non-standard transducer's scale factor must be between 85 and 230 mV/mil. Also, there must be at least 2 volts between the Upper and Lower OK Limits.

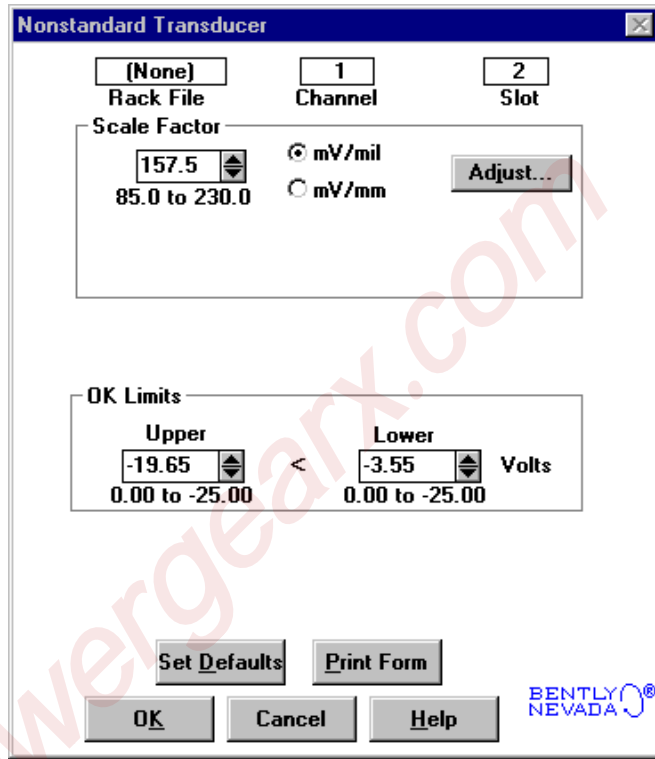

Transducer	Scale Factor				
	Without Barriers	With Bently Nevada Internal Barriers	Standard I/O With Barriers	Discrete TMR I/O With Barriers	Bussed TMR I/O With Barriers
3300 5 and 8 mm	200 mV/mil	200 mV/mil	192 mV/mil	200 mV/mil	199 mV/mil
7200 5 and 8 mm					
7200 11 mm	100 mV/mil	*	*	*	*
7200 14 mm	100 mV/mil	*	*	*	*
3000 (-18V)	200 mV/mil	*	*	*	*
3000 (-24V)	285 mV/mil	*	*	*	*
3300 RAM	200 mV/mil	200 mV/mil	192 mV/mil	200 mV/mil	199 mV/mil
3300 16 mm HTPS	100 mV/mil	*	*	*	*

Note: ±15 % scale factor adjustment allowed.

* Barriers are not supported with this transducer option.

Transducer	OK Limits					
	Upper		Lower		Center Gap Voltage	
	Without Barriers (V)	With Barriers (V)	Without Barriers (V)	With Barriers (V)	Without Barriers (V)	With Barriers (V)
3300 8 mm	-16.75	-16.75	-2.75	-2.75	-9.75	-9.75
3300 5 mm						
7200 5 mm						
7200 8 mm						
7200 11 mm	-19.65	*	-3.55	*	-11.6	*
7200 14 mm	-16.75	*	-2.75	*	-9.75	*
3000 (-18V)	-12.05	*	-2.45	*	-7.25	*
3000 (-24V)	-15.75	*	-3.25	*	-9.5	*
3300 RAM	-12.55	-12.15	-2.45	-2.45	-7.5	-7.3
3300 16 mm HTPS	-16.75	*	-2.75	*	-9.75	*

* Barriers are not supported with this transducer option.
Note: With Barriers includes BNC Internal Barrier I/O Modules.

Transducer Jumper Status (on I/O Module)

Returns the position of the Transducer Jumper on the Proximito/Seismic I/O Module. Refer to Section 4.1(Setting the I/O Jumper)for the function of this jumper.

Alarm Mode

Latching

Once an alarm is active it will remain active even after the proportional value drops below the configured setpoint level. The channel will remain in alarm until it is reset using one of the following methods:

- the reset switch on the front of the Rack Interface Module
- the contact on the Rack Interface I/O Module
- the Reset button in the Operator Display Software
- the reset command through the Communication Gateway Module
- the reset command through the Display Interface Module
- the reset command in the Rack Configuration Software

Nonlatching

When an alarm is active it will go inactive as soon as the proportional value drops below the configured setpoint level.

Alert should be the first level alarm that occurs when the transducer signal level exceeds the selected value. Danger should be the second level alarm that occurs when the transducer signal level exceeds the selected value. The Alert and Danger values are set on the Setpoint screen.

Transducer Orientation

Degrees

The location of the transducer on the machine. The range for orientation angle is 0 to 180 degrees left or right as observed from the driver to the driven end of the machine train. Refer to the following figure:

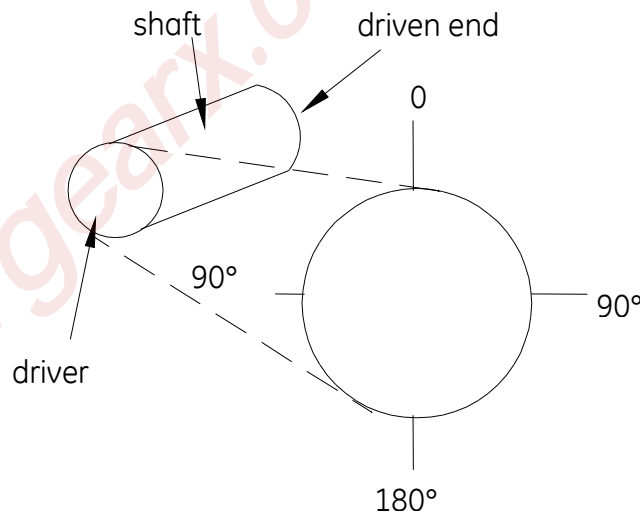

This drawing is for horizontal shafts.

Barriers

Select the MTL 796(-) Zener External option, or Galvanic Isolators if external safety barriers are connected between the monitor and the transducer. If using an Internal Barrier I/O Module, select the internal option. These devices are used to restrict the amount of energy that can flow into a hazardous area.

3.1.3 Thrust Position Channel Options

This section discusses the Configuration Considerations and the Rack Configuration Software screens associated with the Thrust Position Channel.

3.1.3.1 Thrust Position Channel Configuration Considerations

Consider the following items before configuring a Thrust Position Channel:

- Internal Barrier I/O Modules are not currently supported with 7200 11 mm or 14 mm, or 3000 Proximitys, or the 3300 16 mm HTPS.

- The "No Keyphasor" option is automatically selected for this channel type. No Keyphasors are required.
- The Thrust Direct full-scale range is dependent upon the transducer type.
- The Zero Position voltage range is dependent upon the direct full-scale range and the upscale direction.
- Monitors must be configured in channel pairs (for example, Channels 1 and 2 may be configured as Thrust Position and Channels 3 and 4 may be configured as Radial Vibration).
- When a full-scale range is modified, the setpoints associated with this proportional value should be readjusted.
- If a Non-Standard transducer is selected, the setpoint OK limits are set to ± 1 volt from the Upper and Lower OK limits that are selected.
- There are two selections for 3000 Series transducers:

3000(-24V) Proximitors

Select this option when connecting a 3000 Series proximitors directly to a 3500 monitor. A default scale factor of 285 mV/mil will be selected. This may be adjusted ± 15 %. Note that the buffered transducers on the front of the monitors and to the Data Manager are not compensated and should be interpreted at 285 mV/mil.

3000(-18V) Proximitors

Select this option when connecting a 3000 Series proximitors directly to a 3500 monitor, but supplying proximitors power from an external 18 volt source. A default scale factor of 200 mV/mil will be selected. This may be adjusted ± 15 %. Note that the buffered transducers on the front of the monitors and to the Data Manager are not compensated and should be interpreted at 200 mV/mil.

3.1.3.2 Thrust Position Channel Configuration Options

This section describes the options available on the Thrust Position Channel

Thrust Position Channel Options

Channel: (Active) Slot: Rack Type:

Enable

Full-scale Range: Direct Gap Clamp Value:

Recorder Output: Two mA Clamp

OK Mode

Latching Nonlatching

Delay

Alert: 1 - 60 s Danger: 1.0 - 60.0 s 100 ms

Alarm Mode

Alert: Latching Nonlatching

Danger: Latching Nonlatching

Barriers

None Internal MTL 796(-) Zener Ext. Galvanic Isolator

Normal Thrust Direction

Toward Probe Away From Probe

Zero Position (Direct): -6.33 to -13.99 Volts

Transducer Type: Transducer Jumper Status (on I/O Module):

configuration screen.

CP Mod

Selecting the CP Mod button in the Channel Options Dialog Box, allows a Custom channel configuration to be downloaded to the monitor. Custom configuration data is stored in a Custom Products Modification File. Custom Products Modification files follow the naming convention <modification #.mod>. These files must be located in the \3500\Rackcfg\Mods\ directory. When a CP Mod file is selected, a window is displayed which describes the function of the modification. CP Mod files are available through Bently Nevada's Custom Products Division. Contact your local Bently Nevada Sales Representative for details.

Reference Information

These fields contain information that indicates which module you are configuring.

Channel

The number of the channel being configured (1 through 4).

Slot

The location of the monitor in the 3500 rack (2 through 15).

Rack Type

Identifies the type of Rack Interface Module installed in the rack (Standard or TMR).

Enable

Direct

Average position, or change in position, of a rotor in the axial direction with respect to some fixed reference. This value may be displayed in mils or μm . This proportional value supports both center zero and noncenter zero Full Scale Ranges.

Gap

The physical distance between the face of a proximity probe tip and the observed surface. The distance is expressed in terms of voltage. Standard polarity convention dictates that a decreasing gap results in an increasing (less negative) output signal.

Direct Full Scale Ranges by transducer type

3300 - 5 and 8 mm Proximitors 7200 - 5 and 8 mm Proximitors	7200 - 11 and 14 mm Proximitors 3300 - 16 mm HTPS Nonstandard	3000 (-18V) Proximitors 3000 (-24V) Proximitors 3300 RAM Proximitors
25-0-25 mil	25-0-25 mil	25-0-25 mil
30-0-30 mil	30-0-30 mil	0.5 - 0 - 0.5 mm
40-0-40 mil	40-0-40 mil	Custom
0.5 - 0 - 0.5 mm	50-0-50 mil	
1.0 - 0 - 1.0 mm	75-0-75 mil	
Custom	0.5 - 0 - 0.5 mm	
	1.0 - 0 - 1.0 mm	
	2.0 - 0 - 2.0 mm	

Custom

The Gap Full Scale Ranges are the same for all transducer types.

Gap

-24 Vdc

Custom

Clamp Value

The value that a proportional value goes to when that channel or proportional value is Bypassed or defeated. The selected value can be between the minimum and maximum full-scale range values. Only the values available from the Recorder Outputs, Communication Gateway and Display Interface Module are clamped to the specified value when the proportional value is invalid.

Recorder Output

The proportional value of a channel that is sent to the 4 to 20 mA recorder. The recorder output is proportional to the measured value over the channel full scale range. An increase in the proportional value that would be indicated as upscale on a bar graph display results in an increase in the current at the recorder output. If the channel is bypassed, the output will be clamped to the selected clamp value or to 2 mA (if the 2 mA clamp is selected).

OK Mode

Latching

If a channel is configured for Latching OK, once the channel has gone not OK the status stays not OK until a reset is issued. Reset a latched not OK by using one of the following methods:

- the reset switch on the front of the Rack Interface Module
- the contact on the Rack Interface I/O Module
- the Reset button in the Operator Display Software
- the reset command through the Communication Gateway Module
- the reset command through the Display Interface Module
- the reset command in the Rack Configuration Software

Nonlatching

The OK status of that channel will track the defined OK status of the transducer.

Delay

The time which a proportional value must remain at or above an over alarm level or below an under alarm level before an alarm is declared as active.

Alert

First level alarm that occurs when the transducer signal level exceeds the selected Alert/Alarm 1 setpoint. This setpoint can be set on the Setpoint screen. The Alert time delay is always set at one second intervals (from 1 to 60) for all available proportional values.

Danger

Second level alarm that occurs when the transducer signal level exceeds the selected Danger/Alarm 2 setpoint. This setpoint can be set on the Setpoint screen.

100 ms option

The 100 ms (typical) option applies to the Danger time delay only and has the following results:

If the 100 ms option is off ():

- The Danger time delay can be set at one second intervals (from 1 through 60).
- The Danger time delay can be set for all available proportional values.

If the 100 ms option is on ():

- The Danger time delay is set to 100 ms.
- The Danger time delay can only be set for the primary proportional value.

Zero Position (Direct)

Represents the transducer DC voltage corresponding to the zero indication on the channel's meter scale for the direct proportional value. The amount of adjustment allowed is dependent upon the Direct Full Scale Range and the transducer OK limits. For maximum amount of zero adjustment, gap the transducer as close as possible to the ideal zero position voltage based on the full-scale range, the transducer scale factor, and the Upscale Direction. For a mid-scale zero the ideal gap is the center of the range.

Adjust Button

Adjust the Zero Position voltage. When this button is clicked a utility starts that helps you set the direct zero position voltage. Since this utility provides active feedback from the 3500 rack, a connection with the rack is required. Refer to Section 5.2 (Adjusting the Scale Factor and the Zero Position).

Transducer

The following transducer types are available for the Thrust Position Channel (non-barrier I/O module):

- 3300 - 5mm Proximitor
- 3300 - 8mm Proximitor
- 7200 - 5mm Proximitor
- 7200 - 8mm Proximitor
- 7200 - 11mm Proximitor
- 7200 - 14mm Proximitor
- 3000 (-18V) Proximitor
- 3000 (-24V) Proximitor
- 3300 RAM Proximitor
- 3300 - 16mm HTPS
- Nonstandard

The following transducer types are available for the Thrust Position Channel (barrier I/O module):

- 3300 - 5mm Proximitor
- 3300 - 8mm Proximitor
- 7200 - 5mm Proximitor
- 7200 - 8mm Proximitor
- 3300 RAM Proximitor
- Nonstandard

Customize button

Used to adjust the Scale Factor for transducers. If Non-standard is selected as the transducer type, the OK Limits can also be adjusted. The Non-standard transducer's scale factor must be between 85 and 230 mV/mil. Also, there must be at least 2 volts between the Upper and Lower OK Limits.

Transducer	Scale Factor				
	Without Barriers	With Bently Nevada Internal Barriers	Standard I/O With Barriers	Discrete TMR I/O With Barriers	Bussed TMR I/O With Barriers
3300 5 and 8 mm	200 mV/mil	200 mV/mil	192 mV/mil	200 mV/mil	199 mV/mil
7200 5 and 8 mm					
7200 11 mm	100 mV/mil	*	*	*	*
7200 14 mm	100 mV/mil	*	*	*	*
3000 (-18V)	200 mV/mil	*	*	*	*
3000 (-24V)	285 mV/mil	*	*	*	*
3300 RAM	200 mV/mil	200 mV/mil	192 mV/mil	200 mV/mil	199 mV/mil
3300 16 mm HTPS	100 mV/mil	*	*	*	*

Note: ±15 % scale factor adjustment allowed.

* Barriers are not supported with this transducer option.

Transducer	OK Limits					
	Upper		Lower		Center Gap Voltage	
	Without Barriers (V)	With Barriers (V)	Without Barriers (V)	With Barriers (V)	Without Barriers (V)	With Barriers (V)
3300 8 mm	-19.04	-18.20	-1.28	-1.10	-10.16	-9.65
3300 5 mm				-1.28 [†]		-9.74 [†]
7200 5 mm						
7200 8 mm						
7200 11 mm	-20.39	*	-3.55	*	-11.97	*
7200 14 mm	-18.05	*	-1.65	*	-9.85	*
3000 (-18V)	-13.14	*	-1.16	*	-7.15	*
3000 (-24V)	-16.85	*	-2.25	*	-9.55	*
3300 RAM	-13.14	-12.35	-1.16	-1.05 -1.16 [†]	-7.15	-6.7 -6.76 [†]
3300 16 mm HTPS	-18.05	*	-1.65	*	-9.85	*

* Barriers are not supported with this transducer option.
[†] BNC Internal Barrier I/O Modules.

Transducer Jumper Status (on I/O Module)

Returns the position of the Transducer Jumper on the Proximito/Seismic I/O Module. Refer to Section 4.1 (Setting the I/O Jumper) for the function of this jumper.

Alarm Mode

Latching

Once an alarm is active it will remain active even after the proportional value drops below the configured setpoint level. The channel will remain in alarm until it is reset using one of the following methods:

- the reset switch on the front of the Rack Interface Module
- the contact on the Rack Interface I/O Module
- the Reset button in the Operator Display Software
- the reset command through the Communication Gateway Module
- the reset command through the Display Interface Module
- the reset command in the Rack Configuration Software

Nonlatching

When an alarm is active it will go inactive as soon as the proportional value drops below the configured setpoint level.

Alert should be the first level alarm that occurs when the transducer signal level exceeds the selected value. Danger should be the second level alarm that occurs when the transducer signal level exceeds the selected value. The Alert and Danger values are set on the Setpoint screen.

Barriers

Select the MTL 796(-) Zener External option, or Galvanic Isolators if external safety barriers are connected between the monitor and the transducer. If using an Internal Barrier I/O Module, select the internal option. These devices are used to restrict the amount of energy that can flow into a hazardous area.

Normal Thrust Direction

Towards the active thrust bearing (for example towards or away from the probe mounting). This field defines whether rotor movement toward or away from the thrust probe corresponds to a more positive thrust reading (for example upscale on a bar graph). If this field is set to "Toward Probe", then as the rotor moves

toward the thrust probe the thrust position direct proportional value will increase and go upscale on a bar graph.

3.1.4 Differential Expansion Channel Options

This section discusses the Configuration Considerations and the Rack Configuration Software screens associated with the Differential Expansion Channel.

3.1.4.1 Differential Expansion Channel Configuration Considerations

Consider the following items before configuring a Differential Expansion Channel:

- None of the differential expansion channel transducers are able to support discrete Internal Barrier I/O modules.
- The "No Keyphasor" option is automatically selected for this channel type. No Keyphasors are required.
- The Differential Expansion Direct full-scale range is dependent upon the transducer type.
- The Zero Position voltage range is dependent upon the direct full-scale range.
- Monitors must be configured in channel pairs (for example, Channels 1 and 2 may be configured as Differential Expansion and Channels 3 and 4 may be configured as Thrust Position).
- When a full-scale range is modified, the setpoints associated with this proportional value should be readjusted.
- The Latching OK Mode and the Timed OK Channel Defeat options are not compatible.
- If a Non-Standard transducer is selected, the setpoint OK limits are set to ± 1 volt from the Upper and Lower OK limits that are selected.

3.1.4.2 Differential Expansion Channel Configuration Options

This section describes the options available on the Differential Expansion Channel configuration screen.

Differential Expansion Channel Options

Channel: (Active) Slot: Rack Type:

Enable

Full-scale Range: Clamp Value:

Direct: Gap: Zero Position (Direct): -6.40 to -7.50 Volts

Recorder Output: Two mA Clamp

Transducer Type: Customize...
Transducer Jumper Status (on I/O Module):

Delay

Alert: Danger: 100 ms

Upscale Direction: Toward Probe Away From Probe

Alarm Mode

Alert: Latching Nonlatching

Danger: Latching Nonlatching

OK Mode

Latching Nonlatching

Timed OK Channel Defeat

Enabled Disabled

Buttons: BENTLY NEVADA®

CP Mod

Selecting the CP Mod button in the Channel Options Dialog Box, allows a Custom channel configuration to be downloaded to the monitor. Custom configuration data is stored in a Custom Products Modification File. Custom Products Modification files follow the naming convention <modification #.mod>. These files must be located in the \3500\Rackcfg\Mods\ directory. When a CP Mod file is selected, a window is displayed which describes the function of the modification. CP Mod files are available through Bently Nevada's Custom Products Division. Contact your local Bently Nevada Sales Representative for details.

Reference Information

These fields contain information that indicates which module you are configuring.

Channel
 The number of the channel being configured (1 through 4).

Slot
 The location of the monitor in the 3500 rack (12 through 15).

Rack Type
 Identifies the type of Rack Interface Module installed in the rack (Standard or TMR).

Enable
 Direct
 Change in position of the shaft due to the thermal growth relative to the machine casing. This value may be displayed in inches or mm. This proportional value supports both center zero and noncenter zero Full Scale Ranges.

Gap
 The physical distance between the face of a proximity probe tip and the observed surface. The distance is expressed in terms of voltage. Standard polarity convention dictates that a decreasing gap results in an increasing (less negative) output signal.

Direct Full Scale Ranges by transducer type	
25 mm Extended Range Proximitors 35 mm Extended Range Proximitors	50 mm Extended Range Proximitors Nonstandard
5-0-5 mm	5-0-5 mm
0-10 mm	0-10 mm
0.25 - 0 - 0.25 in	10-0-10 mm
0.0 - 0.5 in	0-20 mm
Custom	0-25 mm
	0.25 - 0 - 0.25 in
	0.0 - 0.5 in
	0.5 - 0 - 0.5 in
	0.0 - 1.0 in
	Custom

The Gap Full Scale Ranges are the same for all transducer types.

Gap

-24 Vdc
Custom

Clamp Value

The value that a proportional value goes to when that channel or proportional value is Bypassed or defeated (For example when a problem occurs with the transducer). The selected value can be between the minimum and maximum full-scale range values. Only the values available from the Recorder Outputs, Communication Gateway and Display Interface Module are clamped to the specified value when the proportional value is invalid.

Recorder Output

The proportional value of a channel that is sent to the 4 to 20 mA recorder. The recorder output is proportional to the measured value over the channel full-scale range. An increase in the proportional value that would be indicated as upscale on a bar graph display results in an increase in the current at the recorder output. If the channel is Bypassed, the output will be clamped to the selected clamp value or to 2 mA (if the 2 mA clamp is selected).

OK Mode

Latching

If a channel is configured for Latching OK, once the channel has gone not OK the status stays not OK until a reset is issued. Reset a latched not OK by using one of the following methods:

- the reset switch on the front of the Rack Interface Module
- the contact on the Rack Interface I/O Module
- the Reset button in the Operator Display Software
- the reset command through the Communication Gateway Module
- the reset command through the Display Interface Module
- the reset command in the Rack Configuration Software

Nonlatching

The OK status of the channel will track the defined OK status of the transducer.

Timed OK Channel Defeat

An option that prevents a channel from returning to an OK status until that channel's transducer has remained in an OK state for the specified period of time. If the option is enabled, the time is set to 10 seconds. The option protects against false trips caused by intermittent transducers.

Delay

The time which a proportional value must remain at or above an over alarm level or below an under alarm level before an alarm is declared as active.

Alert

First level alarm that occurs when the transducer signal level exceeds the selected Alert/Alarm 1 setpoint. This setpoint can be set on the Setpoint screen. The Alert time delay is always set at one second intervals (from 1 to 60) for all available proportional values.

Danger

Second level alarm that occurs when the transducer signal level exceeds the selected Danger/Alarm 2 setpoint. This setpoint can be set on the Setpoint screen.

100 ms option

The 100 ms (typical) option applies to the Danger time delay only and has the following results:

If the 100 ms option is off (

- The Danger time delay can be set at one second intervals (from 1 to 60).
- The Danger time delay can be set for all available proportional values.

If the 100 ms option is on (

- The Danger time delay is set to 100 ms.
- The Danger time delay can only be set for the primary proportional value.

Zero Position (Direct)

Represents the transducer DC voltage corresponding to the zero indication on the channel's meter scale for the direct proportional value. The amount of adjustment allowed is dependent upon the Direct Full Scale Range and the transducer OK limits. For maximum amount of zero adjustment, gap the transducer as close as possible to the ideal zero position voltage based on the

full-scale range, the transducer scale factor, and the Upscale Direction. For a mid-scale zero the ideal gap is the center of the range.

Adjust Button

Adjust the Zero Position voltage. When this button is clicked a utility starts that helps you set the direct zero position voltage. Since this utility provides active feedback from the 3500 rack, a connection with the rack is required. Refer to Section 5.2 (Adjusting the Scale Factor and the Zero Position).

Transducer

The following transducer types are available for the Differential Expansion Channel:

- 25mm Extended Range Proximitors
- 35mm Extended Range Proximitors
- 50mm Extended Range Proximitors
- Nonstandard

Customize button

Used to adjust the Scale Factor of transducers. If Non-standard is selected as the transducer type, the OK Limits can also be adjusted. The Non-standard transducer's scale factor must be between 8.5 and 23 mV/mil. Also, there must be at least 2 volts between the Upper and Lower OK Limits.

Scale Factor	
Transducer	Without Barriers
25 mm	20 mV/mil
35 mm	20 mV/mil
50 mm	10 mV/mil

Note: ±15 % scale factor adjustment allowed.

OK Limits			
Transducer	Upper (V)	Lower (V)	Center Gap Voltage (V)
25mm	-12.55	-1.35	-6.95
35mm	-12.55	-1.35	-6.95
50mm	-12.55	-1.35	-6.95

Transducer Jumper Status (on I/O Module)

Returns the position of the Transducer Jumper on the Proximitors/Seismic I/O Module. Refer to Section 4.1 (Setting the I/O Jumper) for the function of this jumper.

Alarm Mode

Latching

Once an alarm is active, it will remain active even after the proportional value drops below the configured setpoint level. The channel will remain in alarm until it is reset using one of the following methods:

- the reset switch on the front of the Rack Interface Module
- the contact on the Rack Interface I/O Module
- the Reset button in the Operator Display Software
- the reset command through the Communication Gateway Module
- the reset command through the Display Interface Module
- the reset command in the Rack Configuration Software

Nonlatching

When an alarm is active, it will go inactive as soon as the proportional value drops below the configured setpoint level. Alert should be the first level alarm that occurs when the transducer signal level exceeds the selected value. Danger should be the second level alarm that occurs when the transducer signal level exceeds the selected value. The Alert and Danger values are set on the Setpoint screen.

Upscale Direction

Towards or away from the probe mounting. This field defines whether rotor movement toward or away from the differential expansion corresponds to a more positive differential expansion (for example upscale on a bar graph). If this field is set to "Toward Probe", then as the rotor moves toward the differential expansion probe the differential expansion direct proportional value will increase and go upscale on a bar graph.

3.1.5 Eccentricity Channel Options

This section discusses the Configuration Considerations and the Rack Configuration Software screens associated with the Eccentricity Channel.

3.1.5.1 Eccentricity Channel Configuration Considerations

Consider the following items before configuring an Eccentricity Channel:

- Internal Barrier I/O Modules are not currently supported with 7200 11 mm or 14 mm, 3000 Proximitors, 3300 16 mm HTPS, or 3300 RAM.
- If a Keyphasor channel is selected, a Keyphasor Module must be installed in the rack.
- The full-scale options allowed for each proportional value is dependent upon the transducer type.
- External barriers are not currently supported with 7200 11 mm, 14 mm, or 3300 16 mm HTPS.
- Monitors must be configured in channel pairs (for example Channels 1 and 2 may be configured as Eccentricity and Channels 3 and 4 may be configured as Thrust Position).
- When a full-scale range is modified, the setpoints associated with this proportional value should be readjusted.
- The Peak to Peak proportional value is disabled when "No Keyphasor" is selected on the Four Channel Proximitors/Seismic Monitor screen.
- The Latching OK Mode and the Timed OK Channel Defeat options are not compatible.
- If a Non-Standard transducer is selected, the setpoint OK limits are set to ± 1 volt from the Upper and Lower OK limits that are selected.

3.1.5.2 Eccentricity Channel Configuration Options

This section describes the options available on the Eccentricity Channel configuration screen.

Eccentricity Channel Options

Channel: (Active) Slot: Rack Type:

Enable

Full-scale Range

Peak to Peak: Clamp Value:

Direct:

Gap:

Recorder Output: Two mA Clamp

Zero Position (Direct): -6.80 to -12.70 Volts

Transducer Type:
 Transducer Jumper Status (on I/O Module):

Delay

Alert: 1 - 60 s
 Danger: 1.0 - 60.0 s 100 ms

Instantaneous Crossover: rpm

Direct Channel Above 600 RPM: Enabled Disabled

Alarm Mode

Alert: Latching Nonlatching

Danger: Latching Nonlatching

Barriers

None Internal
 MTL 796(-) Zener Ext.
 Galvanic Isolator

OK Mode

Latching Nonlatching

Timed OK Channel Defeat

Enabled Disabled

CP Mod

Selecting the CP Mod button in the Channel Options Dialog Box, allows a Custom channel configuration to be downloaded to the monitor. Custom configuration data is stored in a Custom Products Modification File. Custom Products Modification files follow the naming convention <modification #.mod>. These files must be located in the \3500\Rackcfg\Mods\ directory. When a CP Mod file is selected, a window is displayed which describes the function of the modification. CP Mod files are available through Bently Nevada's Custom Products Division. Contact your local Bently Nevada Sales Representative for details.

Reference Information

These fields contain information that indicates which module you are configuring.

Channel

The number of the channel being configured (1 through 4).

Slot

The location of the monitor in the 3500 rack (2 through 15).

Rack Type

Identifies the type of Rack Interface Module installed (Std or TMR).

Enable

Peak to Peak

The difference between the positive and the negative extremes of the rotor bow. The proportional value is only available when a Keyphasor channel has been selected. This value may be displayed in mils or μm .

Direct

The instantaneous eccentricity value. The direct value can be displayed three ways:

- At shaft rotative speeds greater than 600 rpm, the direct value is the average distance between the probe tip and the shaft and is displayed in a way similar to a thrust measurement. This direct measurement is displayed only when Direct Channel Above 600 rpm is enabled.
- At shaft rotative speeds between 600 rpm and the rpm setting for Instantaneous Crossover, the direct measurement consists of two

values: a maximum and minimum value relative to a zero reference. These two direct values are called Direct Max and Direct Min.

- At shaft rotative speeds less than the rpm setting for Instantaneous Crossover, Direct Max and Direct Min are equal and the direct measurement consists of an instantaneous measurement relative to a zero reference. This type of direct measurement is called instantaneous gap.

Instantaneous Crossover

The value for shaft rotative speed where the direct eccentricity measurement changes from Direct Max/ Direct Min to instantaneous gap. The value for Instantaneous Crossover must be between 1 and 10 rpm.

Gap

The physical distance between the face of a proximity probe tip and the observed surface. The distance is expressed in terms of voltage. Standard polarity convention dictates that a decreasing gap results in an increasing (less negative) output signal.

Peak to Peak Full Scale Ranges by transducer type	
3300 - 5 and 8 mm Proximitors	7200 - 11 and 14 mm Proximitors
7200 - 5 and 8 mm Proximitors	3300 - 16 mm HTPS
	Nonstandard
0-5 mil pp	0-5 mil pp
0-10 mil pp	0-10 mil pp
0-20 mil pp	0-20 mil pp
0-30 mil pp	0-30 mil pp
0-100 µm pp	0-50 mil pp
0-200 µm pp	0-100 µm pp
0-500 µm pp	0-200 µm pp
Custom	0-500 µm pp
	0-1000 µm pp
	Custom

Direct Full Scale Ranges by transducer type	
3300 - 5 and 8 mm Proximitor	7200 - 11 and 14 mm Proximitor
7200 - 5 and 8 mm Proximitor	3300 - 16 mm HTPS
	Nonstandard
5-0-5 mil	5-0-5 mil
10-0-10 mil	10-0-10 mil
20-0-20 mil	20-0-20 mil
30-0-30 mil	30-0-30 mil
100-0-100 μm	50-0-50 mil
200-0-200 μm	100-0-100 μm
500-0-500 μm	200-0-200 μm
Custom	500-0-500 μm
	1000-0-1000 μm
	Custom

The Gap values are the same for all transducer types.

Gap

- 24 Vdc
- Custom

Clamp Value

The value that a proportional value goes to when that channel or proportional value is bypassed or defeated (For example when a problem occurs with the transducer). The selected value can be between the minimum and maximum full-scale range values. Only the values available from the Recorder Outputs, Communication Gateway and Display Interface Module are clamped to the specified value when the proportional value is invalid.

Recorder Output

The proportional value of a channel that is sent to the 4 to 20 mA recorder. The recorder output is proportional to the measured value over the channel full-scale range. An increase in the proportional value that would be indicated as upscale on a bar graph display results in an increase in the

current at the recorder output. If the channel is Bypassed, the output will be clamped to the selected clamp value or to 2 mA (if the 2 mA clamp is selected).

Delay

The time which a proportional value must remain at or above an over alarm level or below an under alarm level before an alarm is declared as active.

Alert

First level alarm that occurs when the transducer signal level exceeds the selected Alert/Alarm 1 setpoint. This setpoint can be set on the Setpoint screen. The Alert time delay is always set at one second intervals (from 1 to 60) for all available proportional values.

Danger

Second level alarm that occurs when the transducer signal level exceeds the selected Danger/Alarm 2 setpoint. This setpoint can be set on the Setpoint screen.

100 ms option

The 100 ms (typical) option applies to the Danger time delay only and has the following results:

- If the 100 ms option is off (

50

If the 100 ms option is on (☑):

- The Danger time delay is set to 100 ms.
- The Danger time delay can only be set for the primary proportional value.

Direct Channel Above 600 RPM

Disabled

Display and alarming of the Direct proportional value will be disabled when the shaft rotative speed exceeds 600 rpm.

Enabled

Display and alarming of the Direct proportional value will remain active when shaft rotative speed exceeds 600 rpm.

Zero Position (Direct)

Represents the transducer DC voltage corresponding to the zero indication on the channel's meter scale for the direct proportional value. The amount of adjustment allowed is dependent upon the Direct Full Scale Range and the transducer OK limits. To ensure maximum amount of zero adjustment, gap the probe as close as possible to the center gap voltage specified in the OK Limit table.

Adjust Button

Adjust the Zero Position voltage. When this button is clicked a utility starts that helps you set the direct zero position voltage. Since this utility provides active feedback from the 3500 rack, a connection with the rack is required. Refer to Section 5.2 (Adjusting the Scale Factor and the Zero Position).

Transducer

The following transducer types are available for the Eccentricity Channel (non-barrier I/O module):

- 3300 – 5 mm Proximitior
- 3300 – 8 mm Proximitior
- 3300 – 16 mm HTPS
- 7200 – 5 mm Proximitior
- 7200 – 8 mm Proximitior
- 7200 – 11 mm Proximitior

7200 – 14 mm Proximito
Nonstandard

The following transducer types are available for the Eccentricity Channel (barrier I/O module):

- 3300 – 5 mm Proximito
- 3300 – 8 mm Proximito
- 7200 – 5 mm Proximito
- 7200 – 8 mm Proximito
- Nonstandard

Customize button

Used to adjust the Scale Factor for transducers. If Non-standard is selected as the transducer type, the OK Limits can also be adjusted. The Non-standard transducer's scale factor must be between 85 and 230 mV/mil. Also, there must be at least 2 volts between the Upper and Lower OK Limits.

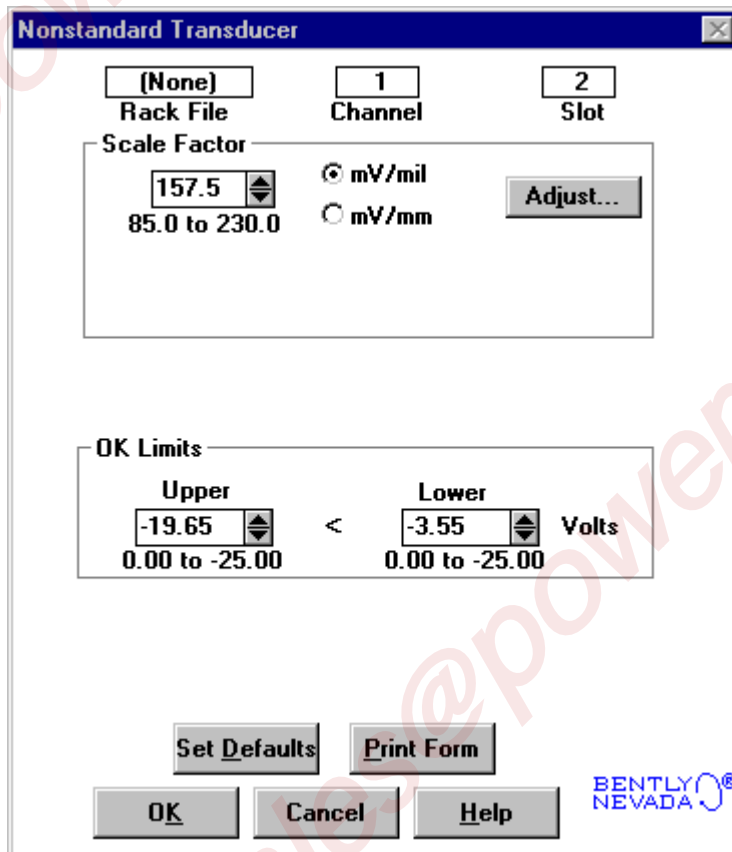

Section 3 - Configuration Information

Transducer	Scale Factor				
	Without Barriers	With Bently Nevada Internal Barriers	Standard I/O With Barriers	Discrete TMR I/O With Barriers	Bussed TMR I/O With Barriers
3300 5 and 8 mm	200 mV/mil	200 mV/mil	192 mV/mil	200 mV/mil	199 mV/mil
7200 5 and 8 mm					
7200 11 mm	100 mV/mil	*	*	*	*
7200 14 mm	100 mV/mil	*	*	*	*
3300 16 mm HTPS	100 mV/mil	*	*	*	*

Note: ±15 % scale factor adjustment allowed.

* Barriers are not supported with this transducer option.

Transducer	OK Limits					
	Upper		Lower		Center Gap Voltage	
	Without Barriers (V)	With Barriers (V)	Without Barriers (V)	With Barriers (V)	Without Barriers (V)	With Barriers (V)
3300 8 mm	-16.75	-16.75	-2.75	-2.75	-9.75	-9.75
3300 5 mm						
7200 5 mm						
7200 8 mm						
7200 11 mm	-19.65	*	-3.55	*	-11.60	*
7200 14 mm	-16.75	*	-2.75	*	-9.75	*
3300 16 mm HTPS	-16.75	*	-2.75	*	-9.75	*

* Barriers are not supported with this transducer option.

Note: With Barriers includes BNC Internal Barrier I/O Modules.

Transducer Jumper Status (on I/O Module)

Returns the position of the Transducer Jumper on the Proximitior/Seismic I/O Module. Refer to Section 4.1 (Setting the I/O Jumper) for the function of

this jumper.

Alarm Mode

Latching

Once an alarm is active, it will remain active even after the proportional value drops below the configured setpoint level. The channel will remain in alarm until it is reset using one of the following methods:

- the reset switch on the front of the Rack Interface Module
- the contact on the Rack Interface I/O Module
- the Reset button in the Operator Display Software
- the reset command through the Communication Gateway Module
- the reset command through the Display Interface Module
- the reset command in the Rack Configuration Software

Nonlatching

When an alarm is active, it will go inactive as soon as the proportional value drops below the configured setpoint level.

Alert should be the first level alarm that occurs when the transducer signal level exceeds the selected value. Danger should be the second level alarm that occurs when the transducer signal level exceeds the selected value. The Alert and Danger values are set on the Setpoint screen.

Barriers

Select the MTL 796(-) Zener External option, or Galvanic Isolators if external safety barriers are connected between the monitor and the transducer. If using an Internal Barrier I/O Module, select the internal option. These devices are used to restrict the amount of energy that can flow into a hazardous area.

OK Mode

Latching

If a channel is configured for Latching OK, once the channel has gone not OK the status stays not OK until a reset is issued. Reset a latched not OK by using one of the following methods:

- the reset switch on the front of the Rack Interface Module
- the contact on the Rack Interface I/O Module
- the Reset button in the Operator Display Software
- the reset command through the Communication Gateway Module
- the reset command through the Display Interface Module
- the reset command in the Rack Configuration Software

Nonlatching

If a channel is configured for Nonlatching OK, the OK status of that channel will track the defined OK status of the transducer.

Timed OK Channel Defeat

An option that prevents a channel from returning to an OK status until that channel's transducer has remained in an OK state for the specified period of time. If the option is enabled, the time is set to 60 seconds. The option protects against false trips caused by intermittent transducers.

3.1.6 Acceleration Channel Options

This section discusses the Configuration Considerations and the Rack Configuration Software screens associated with the Acceleration Channel.

3.1.6.1 Acceleration Channel Configuration Considerations

Consider the following items before configuring an Acceleration Channel:

- The "No Keyphasor" option is automatically selected for this channel type. No Keyphasors are required.
- The Acceleration Direct full-scale range is dependent upon the transducer type.
- Monitors must be configured in channel pairs (for example, Channels 1 and 2 may be configured as Acceleration and Channels 3 and 4 may be configured as Radial Vibration).
- When a full-scale range is modified, the setpoints associated with this proportional value should be readjusted.
- If a Non-Standard transducer is selected, the setpoint OK limits are set to ± 1 volt from the Upper and Lower OK limits that are selected.
- When integration is selected, the available Direct Full-scale ranges will change to reflect this.
- When band-pass filtering is selected, the high-pass and low-pass filters must be set a minimum of two octaves apart.
- When two channels of acceleration are activated, the maximum channel

frequency supported is as shown:

Dual Channel Frequencies	Configuration Settings**		
	Filtering	RMS	Integration
3 to 30 kHz	No	No	No
10 to 30 kHz	No	Yes	No
3 to 9115 Hz	Yes	No	No
10 to 9115 Hz	---	---	Yes
10 to 9115 Hz	Yes	Yes	No

** Three dashes represent both yes and no

- When a single channel of acceleration is activated, the maximum channel frequency supported is as shown:

Single Channel Frequencies	Configuration Settings**		
	Filtering	RMS	Integration
3 to 30 kHz	---	No	No
10 to 30 kHz	---	Yes	No
3 to 9115 Hz	---	---	Yes

** Three dashes represent both yes and no

- The Latching OK Mode and the Timed OK Channel Defeat options are not compatible.
- Internal Barrier I/O Modules and External Barriers are not supported with high frequency accelerometer transducers.
- Only 18 high frequency accelerometer transducers can be installed along with a full rack of standard transducers. This is due to the fact that the rack can only power 18 high frequency Accelerometer transducers.

3.1.6.2 Acceleration Channel Configuration Options

This section describes the options available on the Acceleration Channel configuration screen.

Acceleration Channel Options

Channel: (Active) Slot: Rack Type:

Channel Frequency Support

Enable

Direct Full-scale Range Clamp Value

Integrate

Recorder Output Two mA Clamp

Corner Frequencies

High-pass Filter 3 - 2,000 Hz

Low-pass Filter 20 - 8,000 Hz

Delay

Alert 1 to 60 s

Danger 1.0 to 60.0 s 100 ms

Trip Multiply 1.00 to 3.00 (steps of 0.25)

Transducer Selection

Type

Transducer Jumper Status (on I/O Module):

Alarm Mode

Alert

Latching

Nonlatching

Danger

Latching

Nonlatching

Barriers

None Internal

MTL 796(-) Zener Ext.

Galvanic Isolator

OK Mode

Latching

Nonlatching

Timed OK Channel Defeat

Enabled Disabled

CP Mod

Selecting the CP Mod button in the Channel Options Dialog Box, allows a Custom channel configuration to be downloaded to the monitor. Custom configuration data is stored in a Custom Products Modification File. Custom Products Modification files follow the naming convention <modification #.mod>. These files must be located in the \3500\Rackcfg\Mods\ directory. When a CP Mod file is selected, a window is displayed which describes the function of the modification. CP Mod files are available through Bently Nevada's Custom Products Division. Contact your local Bently Nevada Sales Representative for details.

Reference Information

These fields contain information that indicates which module you are configuring.

Channel

The number of the channel being configured (1 through 4).

Slot

The location of the monitor in the 3500 rack (2 through 15).

Rack Type

Identifies the type of Rack Interface Module installed in the rack (Standard or TMR).

Channel Frequency Support

Supported frequency range of the selected transducer depends upon the number of channels selected. See 3.1.6.1 (Acceleration Channel Configuration Considerations).

Enable

Direct

Machine data using accelerometers for the transducer inputs and generally used for high frequency measurements. The signal will be changed if filtering is selected (High-pass, Low-pass or High-pass and Low-pass selected).

Direct Full Scale Ranges by transducer type		
23733-03 Std Acceleration Interface Module 24145-02 Hi Freq Acceleration Interface Module 330400 Std Integral Accelerometer Nonstandard	49578-01 Std Acceleration Interface Module 155023-01 Hi Freq Acceleration Interface Module	330425 Std Integral Accelerometer
0-2 g pk	0-20 g pk (49578-01 Only)	0-20 g pk
0-5 g pk	0-25 g pk (49578-01 Only)	0-25 g pk
0-10 g pk	0-40 g pk (49578-01 Only)	0-40 g pk
0-20 g pk	0-50 g pk (49578-01 Only)	0-50 g pk
0-25 g pk (23733-03 and Nonstandard Only)	0-20 g rms	0-20 g rms
0-40 g pk (23733-03 and Nonstandard Only)	0-25 g rms	0-25 g rms
0-45 g pk (23733-03 and Nonstandard Only)	0-40 g rms	0-40 g rms
0-2 g rms	0-50 g rms	0-40 g rms
0-5 g rms	0-20 m/s ² rms (49578-01 Only)	0-50 g rms
0-10 g rms	0-50 m/s ² rms (49578-01 Only)	0-20 m/s ² pk
0-20 g rms (Not 24145-02)	0-100 m/s ² rms (49578-01 Only)	0-50 m/s ² pk
0-20 m/s ² pk	0-200 m/s ² rms	0-100 m/s ² pk
0-50 m/s ² pk	0-250 m/s ² rms	0-200 m/s ² pk
0-100 m/s ² pk	0-400 m/s ² rms	0-250 m/s ² pk
0-200 m/s ² pk	0-500 m/s ² rms	0-400 m/s ² pk
0-250 m/s ² pk (23733-03 and Nonstandard Only)	0-20 m/s ² pk (49578-01 Only)	0-500 m/s ² pk
0-400 m/s ² pk (23733-03 and Nonstandard Only)	0-50 m/s ² pk (49578-01 Only)	0-20 m/s ² rms
0-450 m/s ² pk (Nonstandard Only)	0-100 m/s ² pk (49578-01 Only)	0-50 m/s ² rms
0-20 m/s ² rms	0-200 m/s ² pk (49578-01 Only)	0-100 m/s ² rms
0-50 m/s ² rms	0-250 m/s ² pk (49578-01 Only)	0-200 m/s ² rms
0-100 m/s ² rms	0-400 m/s ² pk (49578-01 Only)	0-250 m/s ² rms
0-200 m/s ² rms (Not 24145-02)	0-500 m/s ² pk (49578-01 Only)	0-400 m/s ² rms
Custom	Custom	Custom

Integrate

When Integrate is enabled, the Direct Full-scale range selections change to the following:

Direct values (Integrated) by transducer types	
23733-02 Std Acceleration Interface Module	49578-01 Std Acceleration Interface Module
24145-02 Hi Freq Acceleration Interface Module	155023-01 Hi Freq Acceleration Interface Module
330400 Std Integral Accelerometer Nonstandard	330425 Std Integral Accelerometer
0-1 in/s pk	0-2 in/s pk (Not 155023-01)
0-2 in/s pk	0-2 in/s rms (Not 155023-01)
0-1 in/s rms	0-100 mm/s pk (Not 155023-01)
0-2 in/s rms	0-100 mm/s rms
0-25 mm/s pk	
0-50 mm/s pk	
0-100 mm/s pk (Not 330400)	
0-25 mm/s rms	
0-50 mm/s rms	
Custom	

Clamp Value

The value that a proportional value goes to when that channel or proportional value is bypassed or defeated (for example when a problem occurs with the transducer). The selected value can be between the minimum and maximum full-scale range values. Only the values available from the Recorder Outputs, Communication Gateway and Display Interface Module are clamped to the specified value when the proportional value is invalid.

Recorder Output

The proportional value of a channel that is sent to the 4 to 20 mA recorder. The recorder output is proportional to the measured value over the channel full-scale range. An increase in the proportional value that would be indicated as upscale on a bar graph display results in an increase in the current at the recorder output. If the channel is Bypassed, the output will be clamped to the current proportional to the selected clamp value or to 2 mA (if the 2 mA clamp is selected).

Corner Frequencies

High-pass Filter

A four-pole filter that must be at least two octaves away from the Low-pass Filter.

HPF = High-pass Filter; LPF = Low-pass Filter

$$\text{HPF} \leq (\text{LPF} / 4)$$

Low-pass Filter

A four-pole filter that must be at least two octaves away from the High-pass Filter.

HPF = High-pass Filter; LPF = Low-pass Filter

$$\text{LPF} \geq (\text{HPF} * 4)$$

Delay

The time which a proportional value must remain at or above an alarm level or outside an acceptance region before an alarm is declared as active.

Alert

First level alarm that occurs when the transducer signal level exceeds the selected value. The Alert time delay is always set at one second intervals for all available proportional values.

Danger

Second level alarm that occurs when the transducer signal level exceeds the selected value.

100 ms option

The 100 ms (typical) option applies to the Danger time delay only and has the following results:

If the 100 ms option is off (

- The Danger time delay can be set at one second intervals.
- The Danger time delay can be set for all available proportional values.

If the 100 ms option is on (

- The Danger time delay is set to 100 ms.

- The Danger time delay can only be set for the primary proportional value.

Trip Multiply

The value selected to temporarily increase the alarm (Alert and Danger) setpoint values. This value is normally applied by manual (operator) action during startup to allow a machine to pass through high vibration speed ranges without monitor alarm indications. Such high vibration speed ranges may include system resonances and other normal transient vibrations.

Transducer Selection

The following transducer types are available for the Acceleration Channel (non-barrier I/O module):

- 23733-03 Std Acceleration Interface Module
- 24145-02 Hi Freq Acceleration Interface Module
- 330400 Std Integral Accelerometer
- 330425 Std Integral Accelerometer
- 49578-01 Std Acceleration Interface Module
- 155023-01 Hi Freq Acceleration Interface Module
- Nonstandard

The following transducer types are available for the Acceleration Channel (barrier I/O module):

- 23733-03 Std Acceleration Interface Module
- 330400 Std Integral Accelerometer
- 330425 Std Integral Accelerometer
- 49578-01 Std Acceleration Interface Module
- Nonstandard

Customize button

Used to adjust the Scale Factor for standard transducers. If Non-standard is selected as the transducer type, the Scale Factor and the OK Limits can be adjusted. The Non-standard transducer's scale factor must be between 21.2 and 115 mV/mil. Also, there must be at least 2 volts between the Upper and Lower OK Limits.

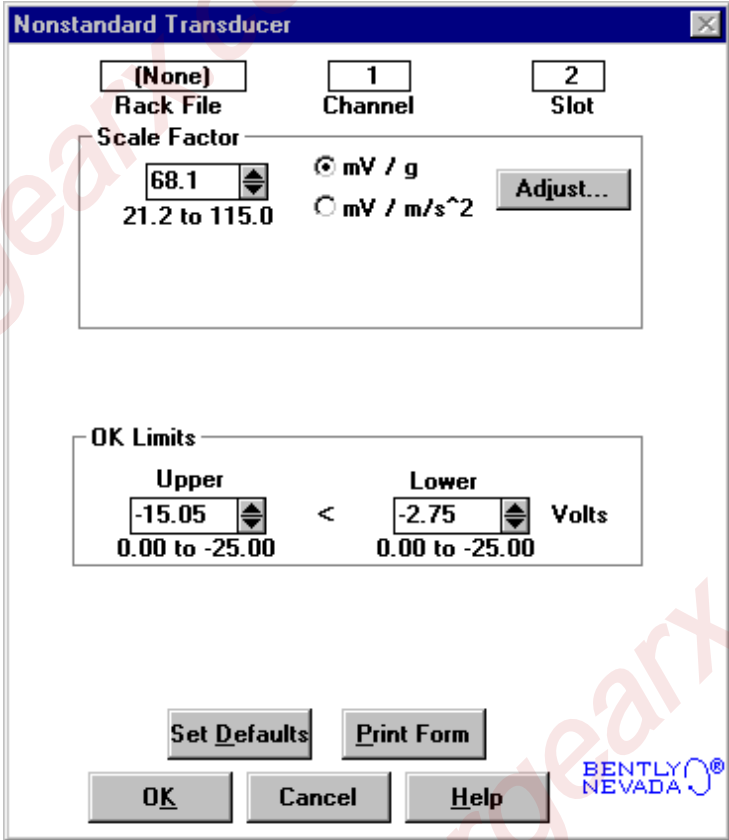

3500/42 Proximito/Seismic Monitor Module Operation and Maintenance Manual

Transducer	Scale Factor				
	Without Barriers	With Bently Nevada Internal Barriers	Standard I/O With Barriers	Discrete TMR I/O With Barriers	Bussed TMR I/O With Barriers
23733-03	100 mV/g	100 mV/g	95.6mV/g	100 mV/g	99.4 mV/g
24145-02	100 mV/g	*	*	*	*
330400	100 mV/g	100 mV/g	95.6mV/g	95.6 mV/g	95.6 mV/g
330425	25 mV/g	25 mV/g	23.9mV/g	23.9 mV/g	23.9 mV/g
49578-01	25 mV/g	25 mV/g	23.9mV/g	25 mV/g	24.9 mV/g
155023-01	25 mV/g	*	*	*	*

Note: ±15 % scale factor adjustment allowed.

* Barriers are not supported with this transducer option.

Transducer	OK Limits					
	Upper		Lower		Center Gap Voltage	
	Without Barriers (V)	With Barriers (V)	Without Barriers (V)	With Barriers (V)	Without Barriers (V)	With Barriers (V)
23733-03	-15.05	-13.85 -15.05 [†]	-2.75	-3.10 -2.75 [†]	-8.90	-8.475 -8.90 [†]
24145-02	-15.05	*	-2.75	*	-8.90	*
330400	-15.05	-13.85 -15.05 [†]	-2.75	-3.10 -2.75 [†]	-8.90	-8.475 -8.90 [†]
330425	-11.37	-10.86 -11.37 [†]	-5.63	-5.34 -5.63 [†]	-8.50	-8.10 -8.50 [†]
49578-01	-11.37	-10.86 -11.37 [†]	-5.63	-5.34 -5.63 [†]	-8.50	-8.10 -8.50 [†]
155023-01	-11.37	*	-5.63	*	-8.50	*

- * Barriers are not supported with this transducer option.
- † BNC Internal Barrier I/O Modules.

Transducer Jumper Status (on I/O Module)

Returns the position of the Transducer Jumper on the Proximito/Seismic I/O Module. Refer to Section 4.1 (Setting the I/O Jumper) for the function of this jumper.

Alarm Mode

Latching

Once an alarm is active, it will remain active even after the proportional value is no longer in alarm. The alarm state will continue until the channel is reset. See Page 54.

Nonlatching

When an alarm is active, it will go inactive as soon as the proportional value is no longer in alarm.

Alert is the first level alarm that occurs when the transducer signal level exceeds the selected value. Danger is the second level alarm that occurs when the transducer signal level exceeds the selected value. The Alert and Danger values are set on the Setpoint screen.

Barriers

Select the MTL 796(-) Zener External option, or Galvanic Isolators if external safety barriers are connected between the monitor and the transducer. If using an Internal Barrier I/O Module, select the internal option. These devices are used to restrict the amount of energy that can flow into a hazardous area.

OK Mode

Latching

If a channel is configured for Latching OK, once the channel has gone not OK the status stays not OK until a reset is issued. See page 54.

Nonlatching

If a channel is configured for Nonlatching OK, the OK status of that channel will track the defined OK status of the transducer.

Timed OK Channel Defeat

An option that prevents a channel from returning to an OK status until that channel's transducer has remained in an OK state for the specified period of time. If the option is enabled, the time is set to 30 seconds. This option prevents false trips caused by intermittent transducers.

3.1.7 Velocity Channel Options

This section discusses the Configuration Considerations and the Rack Configuration Software screens associated with the Velocity Channel.

3.1.7.1 Velocity Channel Configuration Considerations

Consider the following items before configuring a Velocity Channel:

- Internal Barrier I/O Modules are not currently supported with 9200, 47633, 86205, and non-standard 2-wire seismoprobes.
- The "No Keyphasor" option is automatically selected for this channel type. No Keyphasors are required.
- The Velocity Direct full-scale range is dependent upon the transducer type.
- When a full-scale range is modified, readjust the setpoints associated with this proportional value.
- Monitors must be configured in channel pairs (for example, Channels 1 and 2 may be configured as Velocity and Channels 3 and 4 may be configured as Thrust Position).
- When integration is selected, the available Direct Full-scale Ranges will change to reflect this.
- When band-pass filtering is selected, the high-pass and low-pass filters must be set a minimum of a decade apart.
- The 100ms danger alarm is only available for the Velomitor and High Temperature Velomitor options.
- When a single or dual channel of velocity is activated, the maximum channel frequency supported is as shown:

Channel Frequencies	Configuration Settings		
	Filtering	RMS	Integration
3 to 5500 Hz	---	No	---
10 to 5500 Hz	---	Yes	---

** dashes represent both yes and no

- The Latching OK Mode and the Timed OK Channel Defeat options are not compatible.
- If a Non-Standard transducer is selected, the setpoint OK limits are set to ± 1 volt from the Upper and Lower OK limits that are selected.
- If the monitor is configured to alarm on high velocity conditions on a reciprocating machine, it is recommended that you disable the Timed OK/Channel Defeat option.

3.1.7.2 Velocity Channel Configuration Options

This section describes the options available on the Velocity Channel configuration screen.

Velocity Channel Options

Channel: (Active) Slot: Rack Type:

Channel Frequency Support

Enable

Direct Full-scale Range Clamp Value

Integrate

Recorder Out Two mA Clamp

Corner Frequencies

High-pass Filter 3 - 400 Hz

Low-pass Filter 40 - 5,500 Hz

Delay

Alert 1 to 60 s

Danger 1.0 to 60.0 s 100 ms

Trip Multiply 1.00 to 3.00 (steps of 0.25)

Transducer Selection

Type

Transducer Jumper Status (on I/O Module):

Alarm Mode

Alert Latching Nonlatching

Danger Latching Nonlatching

Barriers None Internal MTL 787(-) Zener Ext.

OK Mode Latching Nonlatching

Timed OK Channel Defeat Enabled Disabled

BENTLY NEVADA

CP Mod

Selecting the CP Mod button in the Channel Options Dialog Box, allows a Custom channel configuration to be downloaded to the monitor. Custom configuration data is stored in a Custom Products Modification File. Custom Products Modification files follow the naming convention <modification #.mod>. These files must be located in the \3500\Rackcfg\Mods\ directory. When a CP Mod file is selected, a window is displayed which describes the function of the modification. CP Mod files are available through Bently Nevada's Custom Products Division. Contact your local Bently Nevada Sales Representative for details.

Reference Information

These fields contain information that indicates which module you are configuring.

Channel

The number of the channel being configured (1 through 4).

Slot

The location of the monitor in the 3500 rack (2 through 15).

Rack Type

Identifies the type of Rack Interface Module installed in the rack (Standard or TMR).

Channel Frequency Support

Supported frequency range of the selected transducer which depends upon the number of channels selected. See 3.1.7.1 (Velocity Channel Configuration Considerations).

Enable

Direct

The time rate of change of the displacement. When Integration is selected it yields a peak to peak measurement of the displacement.

The Direct values are available for all transducer types.

Direct

- 0-0.5 in/s pk
- 0-1 in/s pk
- 0-2 in/s pk
- 0 - 0.5 in/s rms
- 0-1 in/s rms
- 0-2 in/s rms
- 0-10 mm/s pk
- 0-20 mm/s pk
- 0-50 mm/s pk
- 0-10 mm/s rms
- 0-20 mm/s rms
- 0-50 mm/s rms
- Custom

Integrate

When Integrate is enabled, the Direct Full-scale Range selections change to the following:

The Direct values (Integrated) are available for all transducer types.

Full-scale Range – Direct

0-5 mil pp
0-10 mil pp
0-20 mil pp
0-100 μm pp
0-200 μm pp
0-500 μm pp
Custom

Clamp Value

The value that a proportional value goes to when that channel or proportional value is bypassed or defeated (for example a problem with the monitor). The selected value can be between the minimum and maximum full-scale range values. Only the values available from the Recorder Outputs, Communication Gateway and Display Interface Module are clamped to the specified value when the proportional value is invalid.

Recorder Output

The proportional value of a channel that is sent to the 4 to 20 mA recorder. The recorder output is proportional to the measured value over the channel full-scale range. An increase in the proportional value that would be indicated as upscale on a bar graph display results in an increase in the current at the recorder output. If the channel is bypassed, the output will be clamped to the selected clamp value or to 2 mA (if the 2 mA clamp is selected).

Corner Frequencies

High-pass Filter

A four-pole filter that must be at least a decade away from the Low-pass Filter.

HPF = High-pass Filter; LPF = Low-pass Filter

$$\text{HPF} \leq (\text{LPF} / 10)$$

Low-pass Filter

A four-pole filter that must be at least a decade away from the High-pass Filter.

HPF = High-pass Filter; LPF = Low-pass Filter

$$\text{LPF} \geq (\text{HPF} * 10)$$

Delay

The time which a proportional value must remain at or above an alarm level or outside an acceptance region before an alarm is declared as active.

Alert

First level alarm that occurs when the transducer signal level exceeds the selected value. The Alert time delay is always set at one second intervals for all available proportional values.

Danger

Second level alarm that occurs when the transducer signal level exceeds the selected value.

100 ms option

The 100 ms (typical) option applies to the Danger time delay only and has the following results:

If the 100 ms option is off (

- The Danger time delay can be set at one second intervals.
- The Danger time delay can be set for all available proportional values.

If the 100 ms option is on (

- The Danger time delay is set to 100 ms.
- The Danger time delay can only be set for the primary proportional value.

Trip Multiply

The value selected to temporarily increase the alarm (Alert and Danger) setpoint values. This value is normally applied by manual (operator) action during startup

to allow a machine to pass through high vibration speed ranges without monitor alarm indications. Such high vibration speed ranges may include system resonances and other normal transient vibrations.

Transducer Selection

The following transducer types are available for the Velocity Channel (non-barrier I/O module):

- 9200 2-wire Seismoprobe
- 47633 2-wire Seismoprobe
- 86205 2-wire Seismoprobe
- Nonstandard 2-wire Seismoprobe
- Velomitor
- High Temperature Velomitor
- Nonstandard

The following transducer types are available for the Velocity Channel (barrier I/O module):

- Velomitor
- High Temperature Velomitor
- Nonstandard

Customize button

Used to adjust the Scale Factor for standard transducers. If Non-standard is selected as the transducer type, the Scale Factor and the OK Limits can be adjusted. The Non-standard transducer's scale factor must be between 90 and 575 mV/mil. Also, there must be at least 2 volts between the Upper and Lower OK Limits.

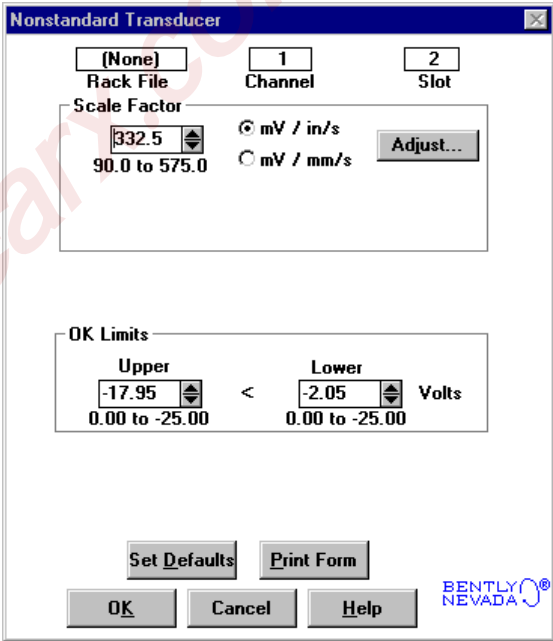

Transducer	Scale Factor		
	Without Barriers	With BNC Internal Barriers	With Barriers
9200	500 mV/(in/s)	*	500 mV/(in/s)
47633	490 mV/(in/s)	*	490 mV/(in/s)
86205	477 mV/(in/s)	*	477 mV/(in/s)
Nonstandard 2 wire	145 mV/(in/s)	*	145 mV/(in/s)
Velomitor	100 mV/(in/s)	100 mV/(in/s)	100 mV/(in/s)
High Temperature Velomitor	145 mV/(in/s)	145 mV/(in/s)	145 mV/(in/s)

Note: ±15 % scale factor adjustment allowed.

* Barriers are not supported with this transducer option.

Transducer	OK Limits					
	Upper		Lower		Center Gap Voltage	
	Without Barriers (V)	With Barriers (V)	Without Barriers (V)	With Barriers (V)	Without Barriers (V)	With Barriers (V)
9200	-17.95	-17.95	-2.05	-2.05	-10.00	-10.00
47633	-17.95	-17.95	-2.05	-2.05	-10.00	-10.00
86205	-17.95	-17.95	-2.05	-2.05	-10.00	-10.00
NonStandard	-17.95	-17.95	-2.05	-2.05	-10.00	-10.00
Velomitor	-19.85	-17.95 -19.85 †	-4.15	-2.05 -4.15 †	-12.00	-10.00 -12.00 †
High Temperature Velomitor	-21.26	-21.26	-2.74	-2.74	-12.00	-12.00

* Barriers are not supported with this transducer option.

† BNC Internal Barrier I/O Modules.

Transducer Jumper Status (on I/O Module)

Returns the position of the Transducer Jumper on the Proximitor/Seismic I/O Module. Refer to Section 4.1 (Setting the I/O Jumper) for the function of this jumper.

Take Input From Channel A (1 or 3) Transducer

The Channel B (2 or 4) Velocity channel options screen has an extra control that appears just above the transducer type list box (see figure below). It is the Take Input from Channel A Transducer checkbox. When checked () , the channel pair uses Dual Path Input. That is, input from the first channel (1 or 3) is used for both channels in the pair. The transducer input, barrier, OK Mode, and Timed OK Channel Defeat input from channel A will be copied to the second channel (2 or 4) in the channel pair.

Velocity Channel Options

Channel: **2** (Active) Slot: **2** Rack Type: **Standard**

Channel Frequency Support: **3 - 5,500 Hz**

Enable

Direct: **0-0.5 in/s pk** Full-scale Range: **0.000** Clamp Value

Integrate

Recorder Out: **None** Two mA Clamp

Corner Frequencies

High-pass Filter: **None** 3 - 400 Hz

Low-pass Filter: **None** 40 - 5,500 Hz

Delay

Alert: **3** 1 to 60 s

Danger: **1.0** 1.0 to 60.0 s 100 ms

Trip Multiply: **1.00** 1.00 to 3.00 (steps of 0.25)

Transducer Selection

Take Input From Channel 1 Transducer

Type: **Velomitor** Customize...

Transducer Jumper Status (on I/O Module): **N/A**

Alarm Mode

Alert: Latching Nonlatching

Danger: Latching Nonlatching

Barriers: None Internal MTL 787(-) Zener Ext.

OK Mode: Latching Nonlatching

Timed OK Channel Defeat: Enabled Disabled

Buttons: **OK** **Set Defaults** **Cancel** **CP Mod** **Print Form** **Help** **BENTLY NEVADA®**

Velocity Channel Options Screen for Channel B

Alarm Mode

Latching

Once an alarm is active it will remain active even after the proportional value is no longer in alarm. The alarm state will continue until the channel is reset. See Page 54.

Nonlatching

When an alarm is active, it will go inactive as soon as the proportional value is no longer in alarm.

Alert is the first level alarm that occurs when the transducer signal level exceeds the selected value. Danger is the second level alarm that occurs when the transducer signal level exceeds the selected value. The Alert and Danger values are set on the Setpoint screen.

Barriers

For Seismoprobes, select the MTL 764(-) Zener External option if external safety barriers are connected between the monitor and the transducer. For Velomitor, select the MTL 787(-) Zener External option if external safety barriers are being used. If using an Internal Barrier I/O Module for Velomitor, select the internal option. These devices are used to restrict the amount of energy that can flow into a hazardous area.

OK Mode

Latching

If a channel is configured for Latching OK, once the channel has gone not OK, the status stays not OK until a reset is issued. See page 54.

Nonlatching

If a channel is configured for Nonlatching OK, the OK status of that channel will track the defined OK status of the transducer.

Timed OK Channel Defeat

An option that prevents a channel from returning to an OK status until that channel's transducer has remained in an OK state for the specified period of time. If the option is enabled, the time is set to 30 seconds. This option prevents false trips caused by intermittent transducers.

3.2 Setpoints

This section specifies the available setpoints for each type of channel. A setpoint is the level within the full-scale range that determines when an alarm occurs. The 3500 Monitoring System allows Alert/Alarm 1 setpoints to be set for every proportional value on each channel. The channel will drive an Alert/Alarm 1

indication if one or more of the channel proportional values exceeds its setpoints. The 3500 Monitoring System also allows up to four Danger/Alarm 2 setpoints (two over setpoints and two under setpoints) to be set for up to two of the proportional values. You may select any two of the available proportional values for the

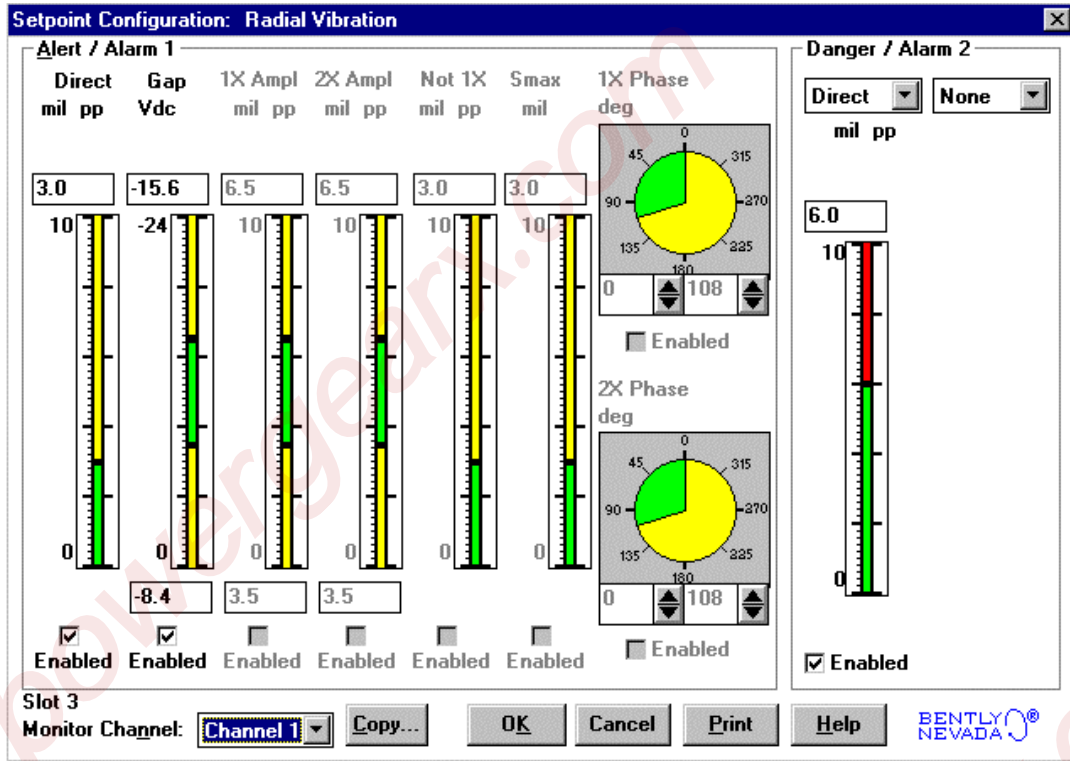

channel.

Note

The setpoint over and under limits can only be placed within the OK limits of the specified transducer.

Use the following screen in the Rack Configuration Software to adjust Alert/Alarm 1 and Danger/Alarm 2 setpoints. This screen will vary depending upon the type of channel.

The following table lists the Alert/Alarm 1 and Danger/Alarm 2 setpoints available for each channel pair type. The setpoint number is used in the Communication Gateway and Display Interface Modules.

Setpoint Number	Radial Vibration	Thrust Position	Differential Expansion
1	Over Direct	Over Direct	Over Direct
2	Over Gap	Under Direct	Under Direct
3	Under Gap	Over Gap	Over Gap
4	Over 1X Ampl	Under Gap	Under Gap
5	Under 1X Ampl	Danger (configurable)	Danger (configurable)
6	Over 1X Phase Lag	Danger (configurable)	Danger (configurable)
7	Under 1X Phase Lag	Danger (configurable)	Danger (configurable)
8	Over 2X Ampl	Danger (configurable)	Danger (configurable)
9	Under 2X Ampl		
10	Over 2X Phase Lag		
11	Under 2X Phase Lag		
12	Over Not 1X Ampl		
13	Over S_{max} Ampl		
14	Danger (configurable)		
15	Danger (configurable)		
16	Danger (configurable)		
17	Danger (configurable)		

Setpoint Number	Eccentricity	Acceleration	Velocity
1	Over Peak to Peak	Over Direct	Over Direct
2	Over Gap	Danger (Over Direct)	Danger (Over Direct)
3	Under Gap		
4	Over Direct Max		
5	Under Direct Max		
6	Over Direct Min		
7	Under Direct Min		
8	Danger (configurable)		
9	Danger (configurable)		
10	Danger (configurable)		
11	Danger (configurable)		

All the Alert/Alarm 1 setpoints are provided first, followed by the configured danger setpoints.

Example 1:

Radial Vibration with the Danger/Alarm 2 Over 2X Ampl setpoint and the Danger/Alarm 2 Under 2X Ampl setpoint selected.

Alert/Alarm 1 setpoints: setpoints 1 through 13

Danger/Alarm 2 setpoints: setpoint 14 is Over 2X Ampl (Danger)
setpoint 15 is Under 2X Ampl (Danger)

Example 2:

Thrust Position with the Danger/Alarm 2 Over Gap setpoint and the Danger/Alarm 2 Under Gap setpoint selected.

- Alert/Alarm 1 setpoints: setpoints 1 through 4
- Danger/Alarm 2 setpoints: setpoint 5 is Over Gap (Danger)
setpoint 6 is Under Gap (Danger)

3.3 Software Switches

The Proximator/Seismic Monitor supports two module software switches and four channel software switches. These switches let you temporarily bypass or inhibit monitor and channel functions. Set these switches on the **Software Switches** screen under the **Utilities** Option on the main screen of the Rack Configuration Software.

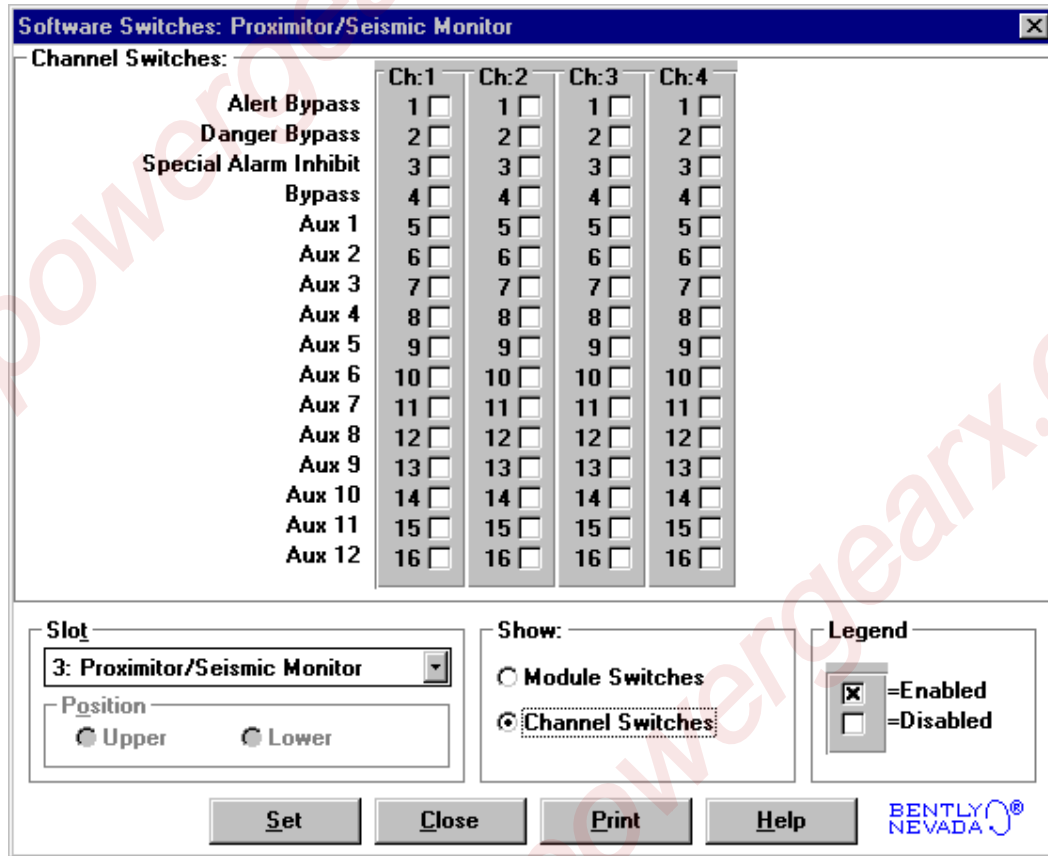

No changes will take effect until the **Set** button is pressed.

Module Switches

Configuration Mode

A switch that allows the monitor to be configured. To configure the monitor, enable (☒) this switch and set the key switch on the front of the Rack Interface Module in the PROGRAM position. When downloading a configuration from the Rack Configuration Software, this switch will automatically be enabled and disabled by the Rack Configuration Software. If the connection to the rack is lost during the configuration process, use this switch to remove the module from Configuration Mode.

Monitor Alarm Bypass

When enabled, the monitor does not perform alarming functions. All proportional values are still provided. The monitor switch number is used in the Communication Gateway and Display Interface Modules.

Monitor Switch Number	Switch Name
1	Configuration Mode
3	Monitor Alarm Bypass

Channel Switches

Alert Bypass

When enabled, the channel does not perform Alert alarming functions.

Danger Bypass

When enabled, the channel does not perform Danger alarming functions.

Special Alarm Inhibit

When enabled, all nonprimary Alert alarms are inhibited.

Bypass

When enabled, the channel provides no alarming functions and supplies no proportional values.

The channel switch number is used in the Communication Gateway and Display Interface Modules.

Channel Switch Number	Switch Name
1	Alert Bypass
2	Danger Bypass
3	Special Alarm Inhibit
4	Bypass

4. I/O Module Descriptions

The Proximator®/Seismic I/O Module receives signals from the transducers and routes the signals to the Proximator/Seismic Monitor. The I/O module supplies power to the transducers. The I/O module also provides a 4 to 20 mA recorder output for each transducer input channels. Only one I/O module can be installed at any one time and must be installed behind the monitor (in a rack mount or panel mount rack) or above the monitor (in a Bulkhead rack).

The 3500/42 Proximator®/Seismic Monitor can operate with the following types of I/O modules:

Internal Termination	External Termination	External Termination Block
Proximator®/Seismic I/O module	Proximator®/Seismic I/O module	Terminal strip connectors
Proximator®/Seismic Internal Barrier I/O module	Proximator®/Seismic TMR I/O module	Euro Style connectors

This section describes how to use the connectors on the I/O modules, lists what cables should be used, and shows the pin outs of the cables. The 3500 Field Wiring Diagram Package (part number 130432-01) shows how to connect transducers and recorders to the I/O module or the External Termination Block.

4.1 Setting the I/O Jumper

The I/O jumper on the Proximator/Seismic I/O Module is used to identify the type of transducer connected to the I/O module.

Note

The connector shunt must be installed vertically on the top or bottom four terminal posts to select the corresponding transducer type.

WARNING - Do not place shunt over NOT USED terminal posts. The connector shunt must be placed over the terminal posts for which the channel pair is configured, even when the channel pair is inactivated.

PROX/ACCL (Proximito/Accelerometer):

The four-pin connector shunt must be installed on the top left four terminal posts.

STANDARD

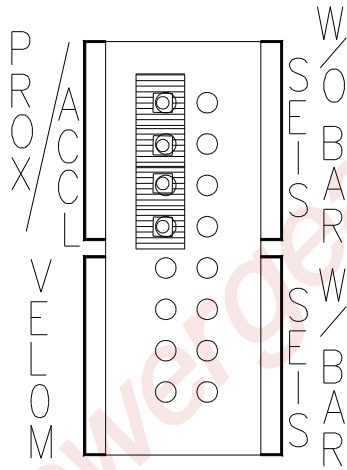

TMR

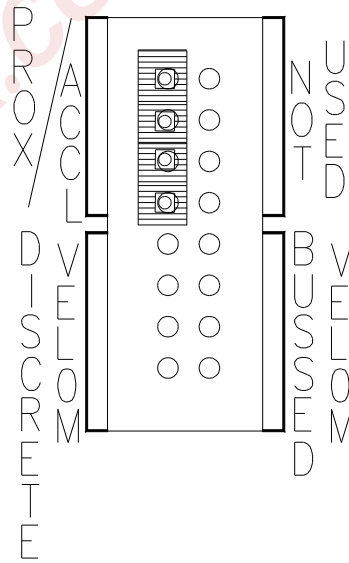

SEIS W/O BAR (Seismoprobe without a Barrier):

The four-pin connector shunt must be installed on the top right four terminal posts.

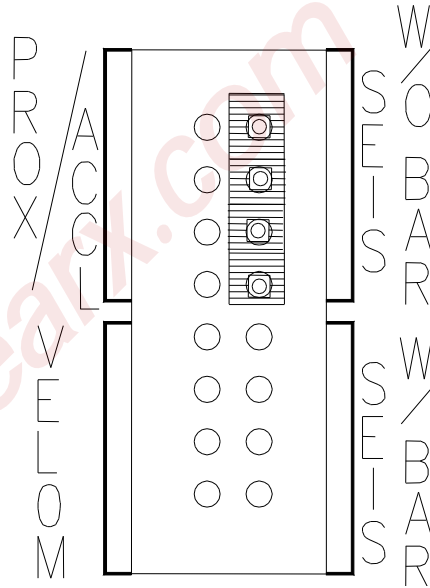

VELOM (Velomitor):

The four-pin connector shunt must be installed on the bottom left four terminal posts.

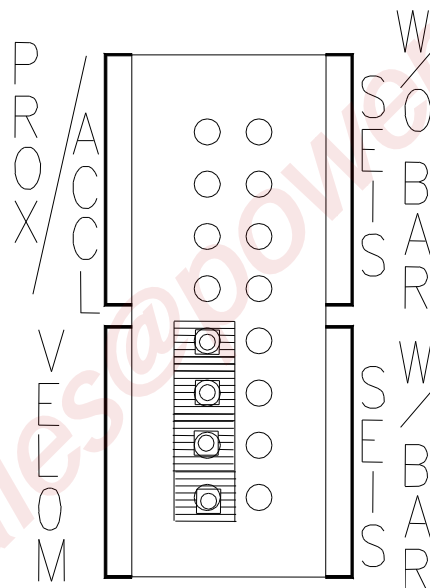

SEIS W/ BAR (Seismoprobe with Barrier):

The four-pin connector shunt must be installed on the bottom right terminal posts.

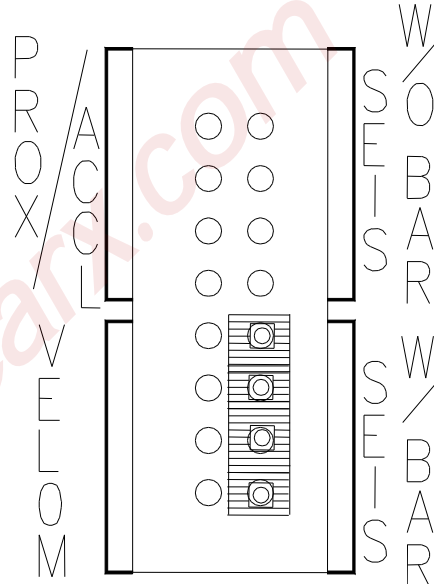

DISCRETE VELOM (Discrete Velomitor):

The four-pin connector shunt must be installed on the bottom left four terminal posts.

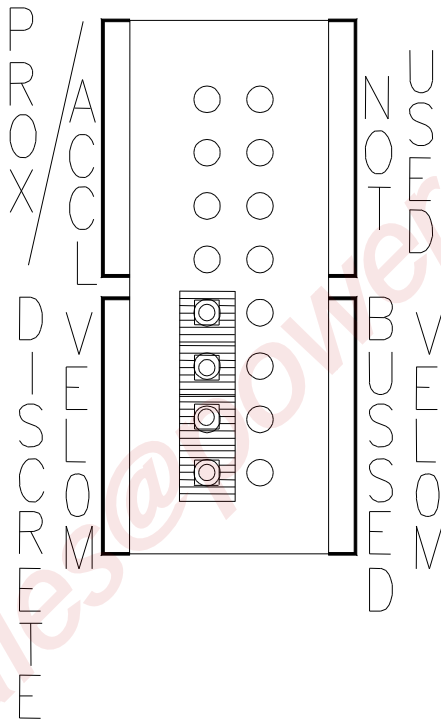

BUSSED VELOM (Bussed Velomitor):

The four-pin connector shunt must be installed on the bottom right terminal posts.

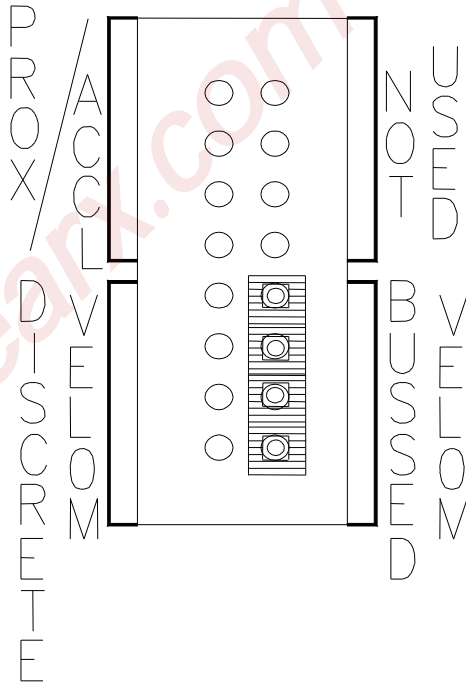

4.2 Proximito/Seismic I/O Module (Internal Termination)

Internal Termination I/O modules require you to wire each transducer and recorder directly to the I/O module. This section shows what this Internal Termination I/O module looks like and how to connect the wires to the Euro Style connector.

Connect the wire from the transducers associated with Channel 1 and 2 to the I/O module.

Connect the wire from the transducers associated with Channel 3 and 4 to the I/O module.

INH/RET: Connect to an external switch. Used to inhibit all non-primary Alert/Alarm 1 functions for all four channels.

COM/REC: Connect each channel of the I/O module

connector.

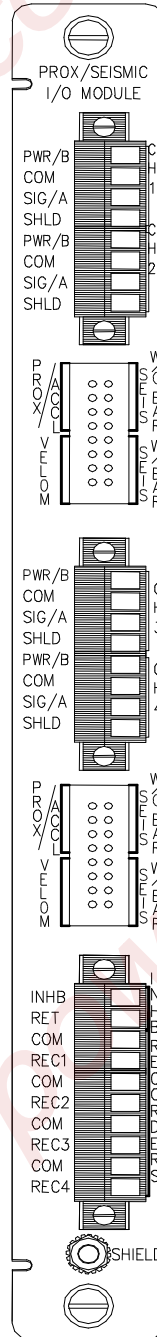

Use the jumper to select the type of transducer connected to Channel 1 and 2 of

Use the jumper to select the type of transducer connected to Channel 3 and 4 of

4.3 Proximito/Seismic Internal Barrier I/O Module (Internal Termination)

The Internal Barrier I/O modules requires that each transducer be connected to the Barrier I/O module individually. This module provides four channels of intrinsically safe signal conditioning for Proximito and/or Seismic transducers and has two internally mounted zener barrier modules, one for each pair of transducer channels. There are three types of Internal Barrier I/O Module; the first variant provides four channels for Proximito transducers only, the second provides two channels for Proximito transducers and two for Seismic transducers, and the third provides four channels for Seismic transducers only. A 3500 Earthing Module is required for systems that use Internal Barrier I/O Modules to provide an intrinsically safe earth connection for intrinsically safe applications. Refer to the Rack Installation and Maintenance Manual for system requirements when using Internal Barrier I/O Modules.

Connect the wires from Proximito transducers to the Barrier I/O Module.

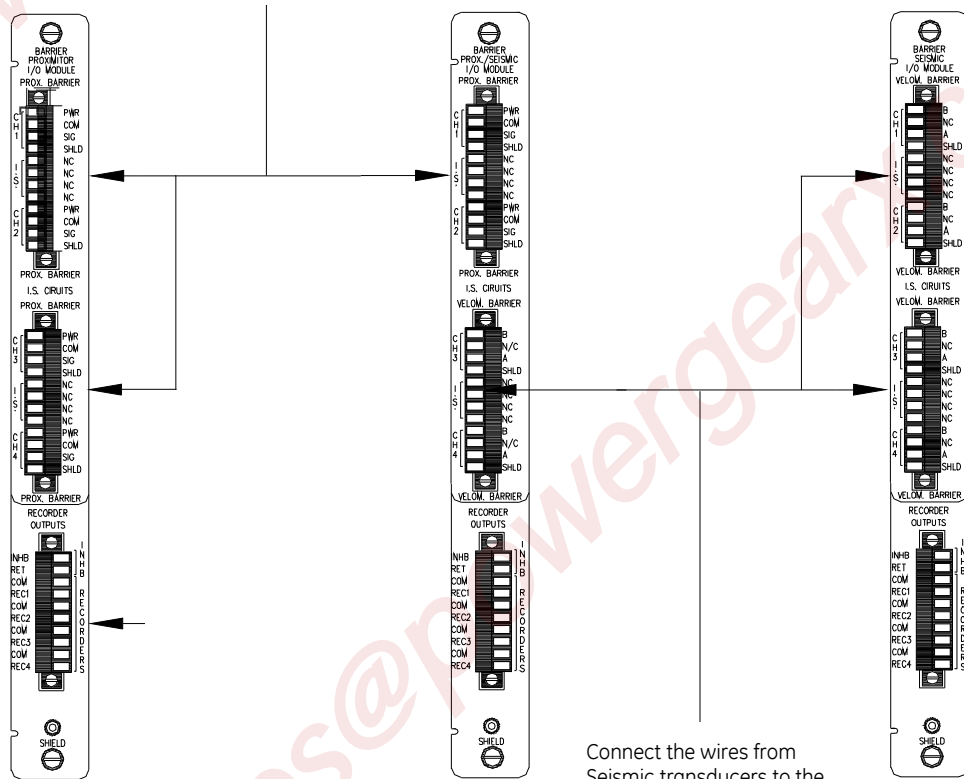

4.4 Wiring Euro Style Connectors

To remove a terminal block from its base, loosen the screws attaching the terminal block to the base, grip the block firmly and pull. Do not pull the block out by its wires because this could loosen or damage the wires or connector.

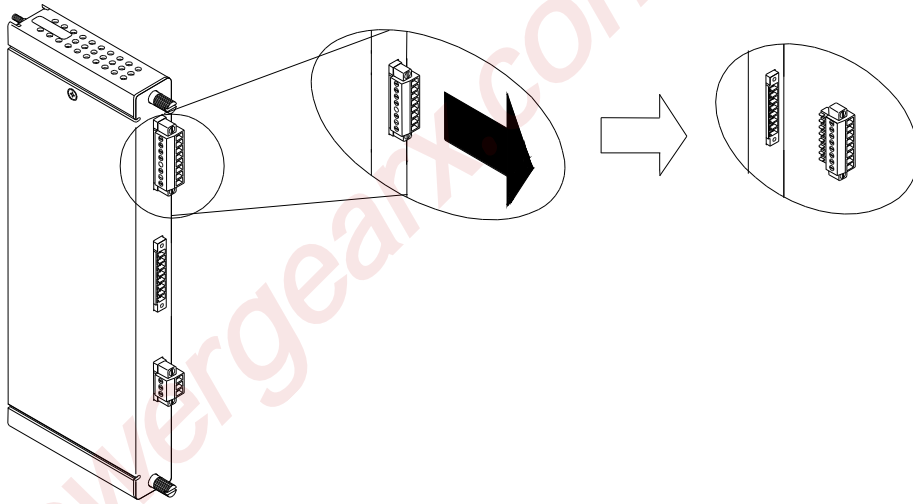

Typical I/O module

Refer to the 3500 Field Wiring Diagram Package for the recommended wiring. Do not remove more than 6 mm (0.25 in) of insulation from the wires.

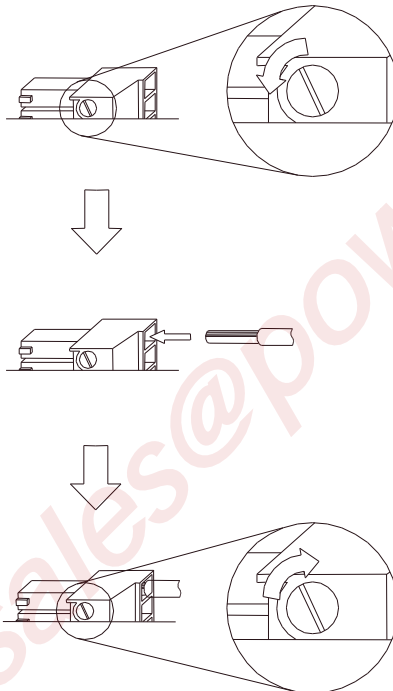

4.5 External Termination I/O Modules

External Termination I/O modules let you simplify the wiring to the I/O modules in a 3500 rack by using a 25-pin cable to route the signals from the four transducers and a nine pin cable to route the signals from the recorders to the I/O module. This section describes the External Termination I/O modules available for use with the Proximator/Seismic Monitor. It also shows what these External Termination I/O modules look like, what the External Termination Blocks look like, and the pin outs of the cables that go between the External Termination I/O modules and the External Termination Blocks.

4.5.1 Proximator/Seismic I/O Module (External Termination)

This section discusses the features of the Proximator/Seismic I/O Module.

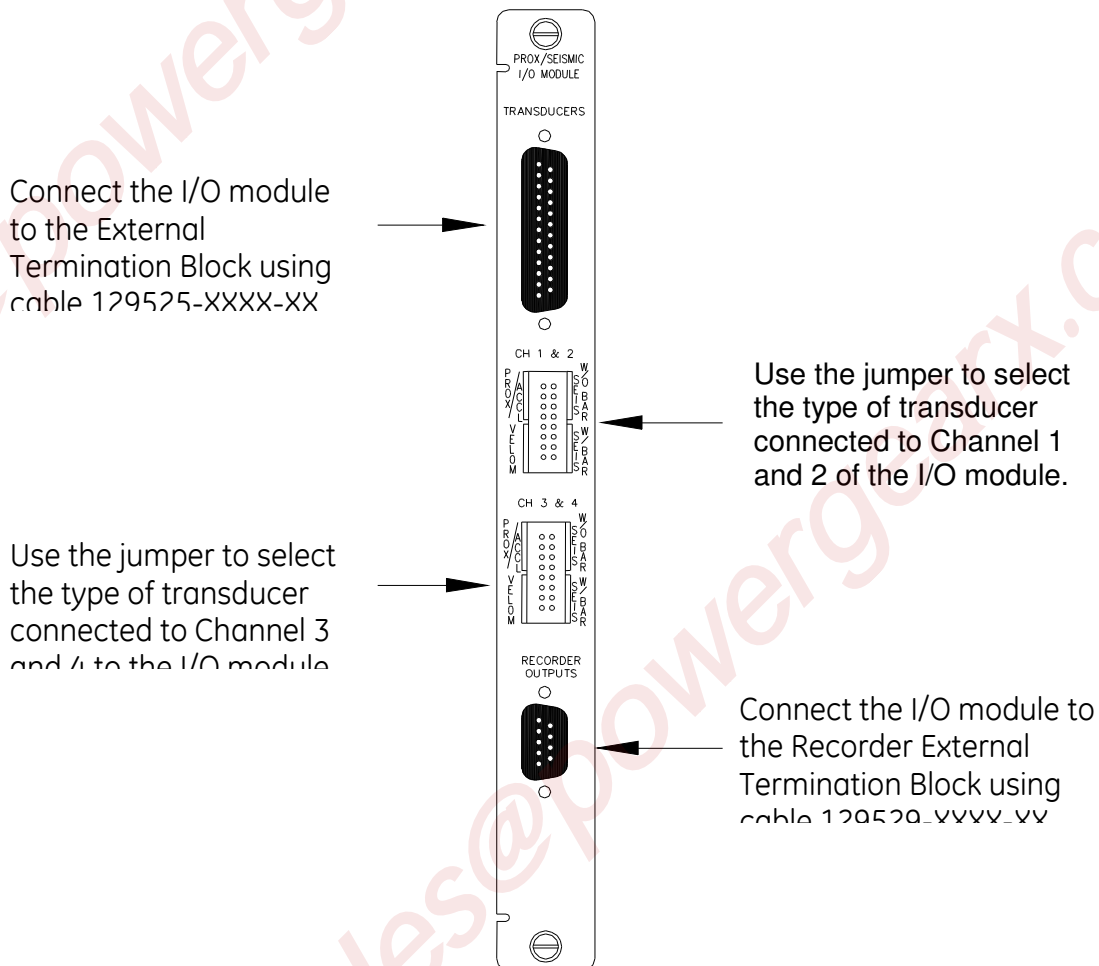

4.5.2 Proximitor/Seismic TMR I/O Module (External Termination)

The Proximitor/Seismic TMR I/O Module is used in a TMR rack and can be configured as TMR I/O Discrete or TMR I/O Bussed.

When configured as TMR I/O Discrete, twelve transducers send input signals to three monitors so that each transducer signal of each channel is not shared by other channels. Six External Termination Blocks are required: three are Proximitor/Seismic External Termination Blocks used to wire the transducers; the other three are Recorder External Termination Blocks used to wire the recorders.

When configured as TMR I/O Bussed, four transducers are bussed to three monitors so that each transducer is shared by three channels, one channel from each monitor. Four External Termination Blocks are required: one is a Bussed Proximitor/Seismic External Termination Block used to wire the transducers; the other three are Recorder External Termination Blocks used to wire the recorders.

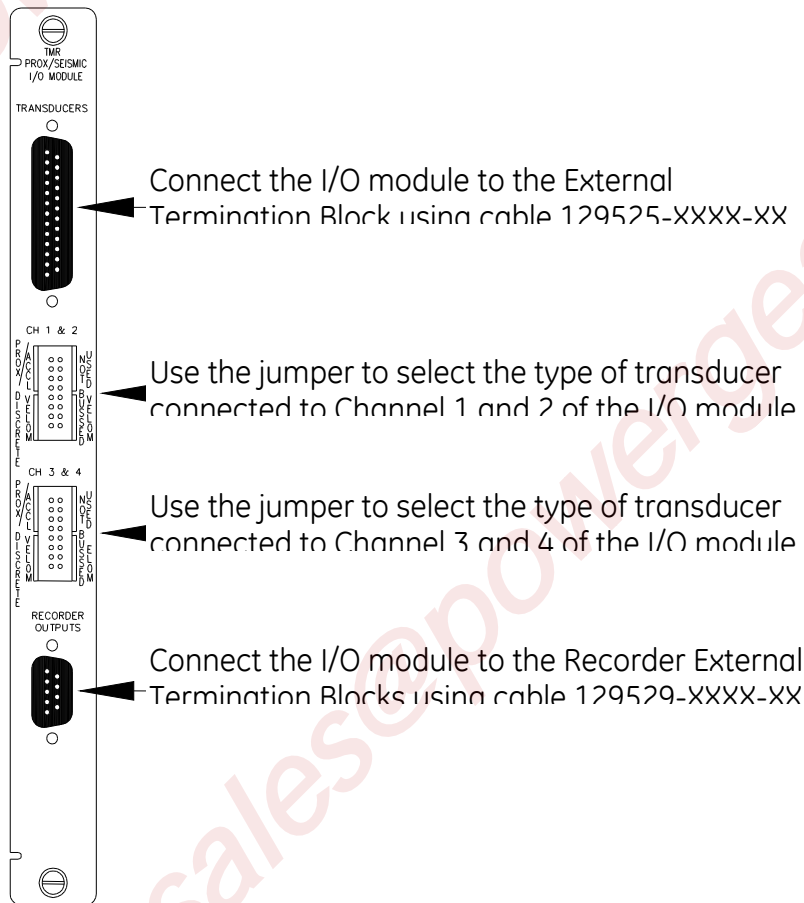

4.5.3 External Termination Blocks

The three types of External Termination Blocks used with a Proximito/Seismic I/O Module are the Proximito/Seismic External Termination Blocks, the Bussed Proximito/Seismic External Termination Blocks, and the Recorder External Termination Blocks. Each type comes with either Terminal Strip or Euro Style connectors.

4.5.3.1 Proximito/Seismic External Termination Block (Terminal Strip connectors)

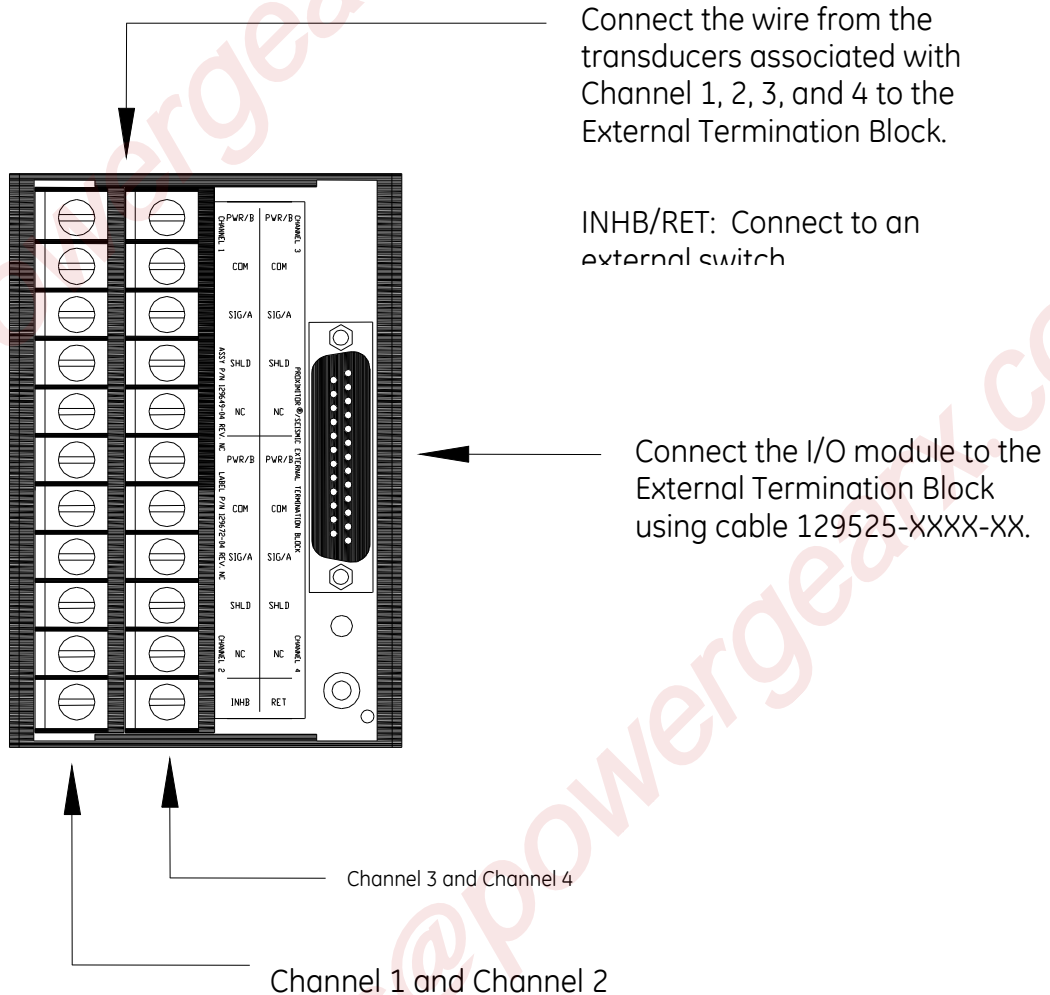

4.5.3.2 Proximito/Seismic External Termination Block (Euro Style connectors)

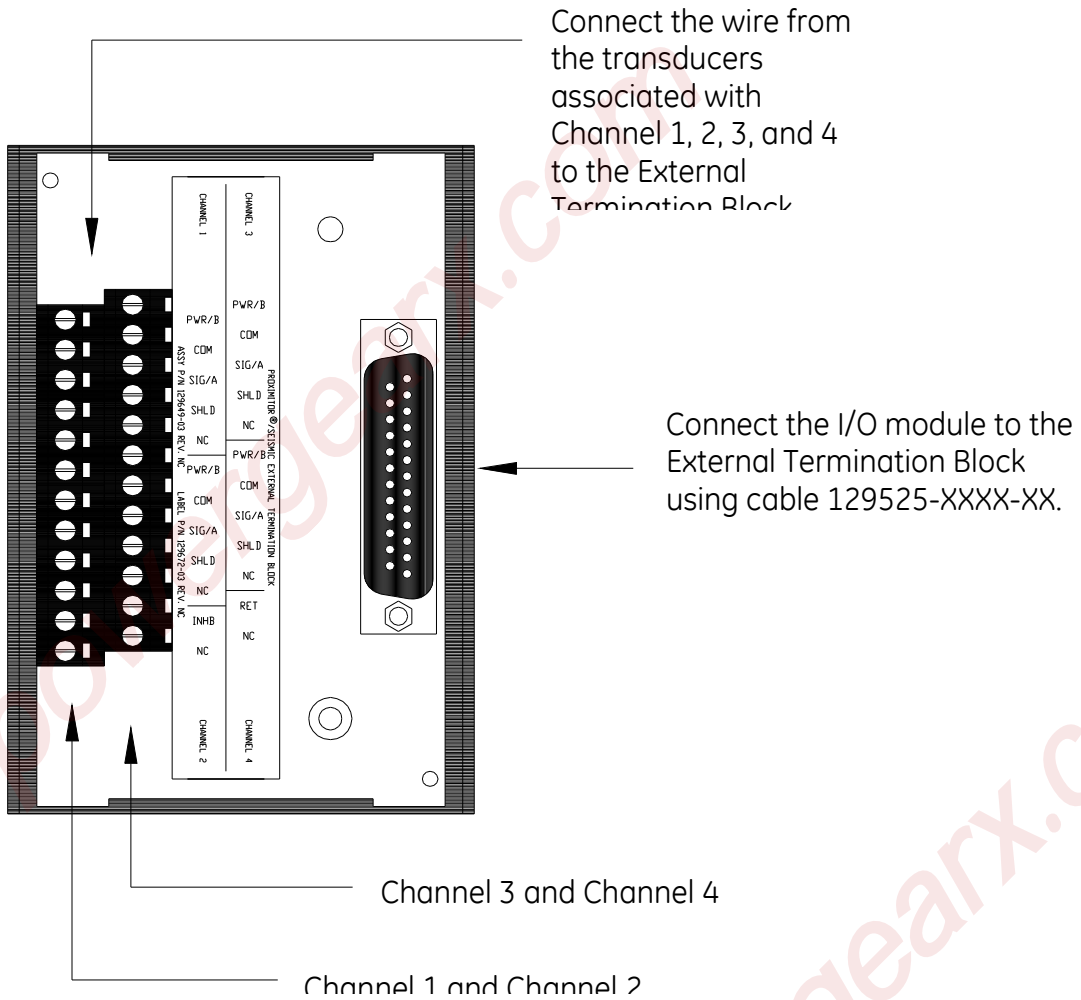

4.5.3.3 Bussed Proximator/Seismic External Termination Block (Terminal Strip connectors)

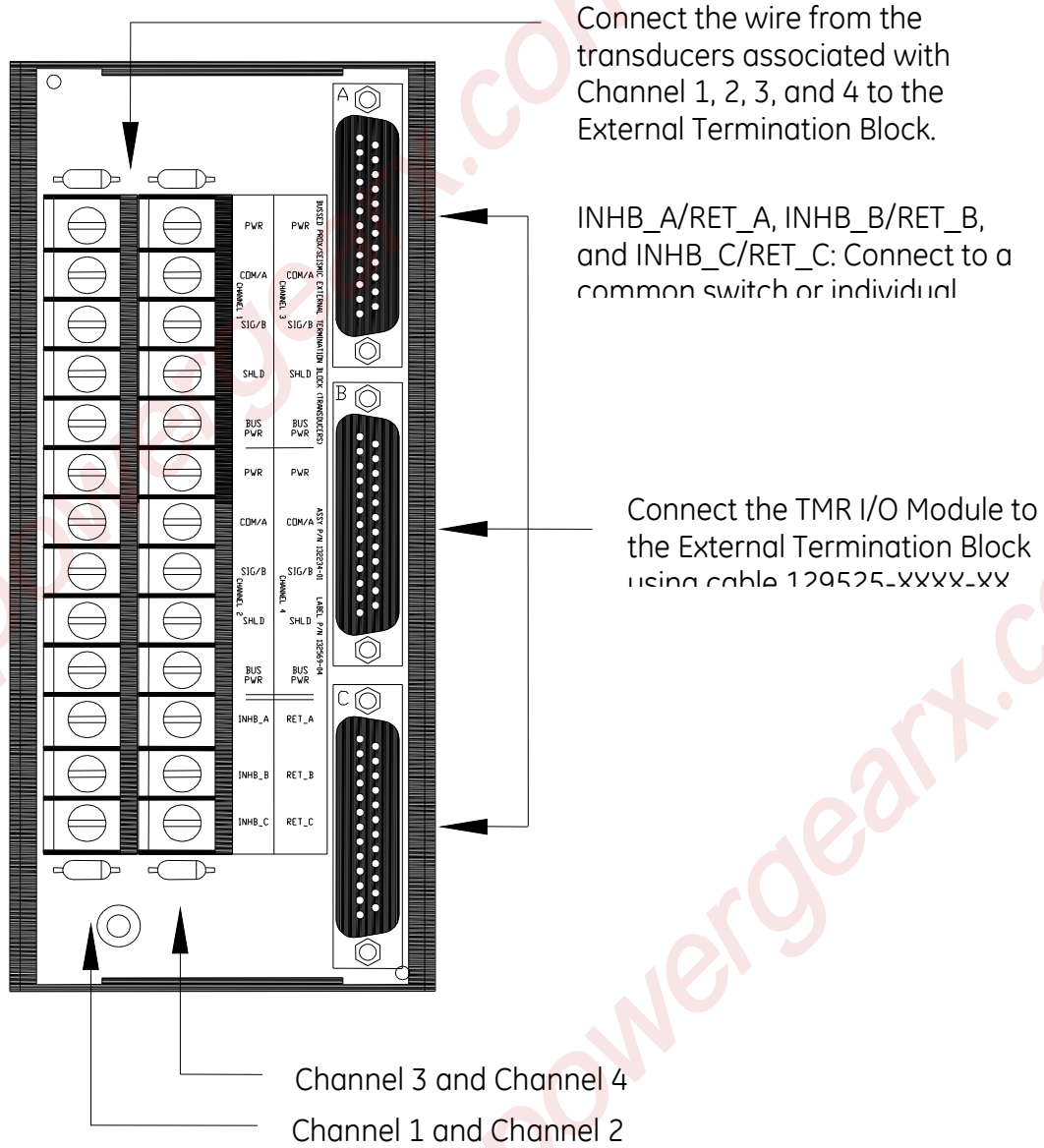

4.5.3.4 Bussed Proximator/Seismic External Termination Block (Euro Style connectors)

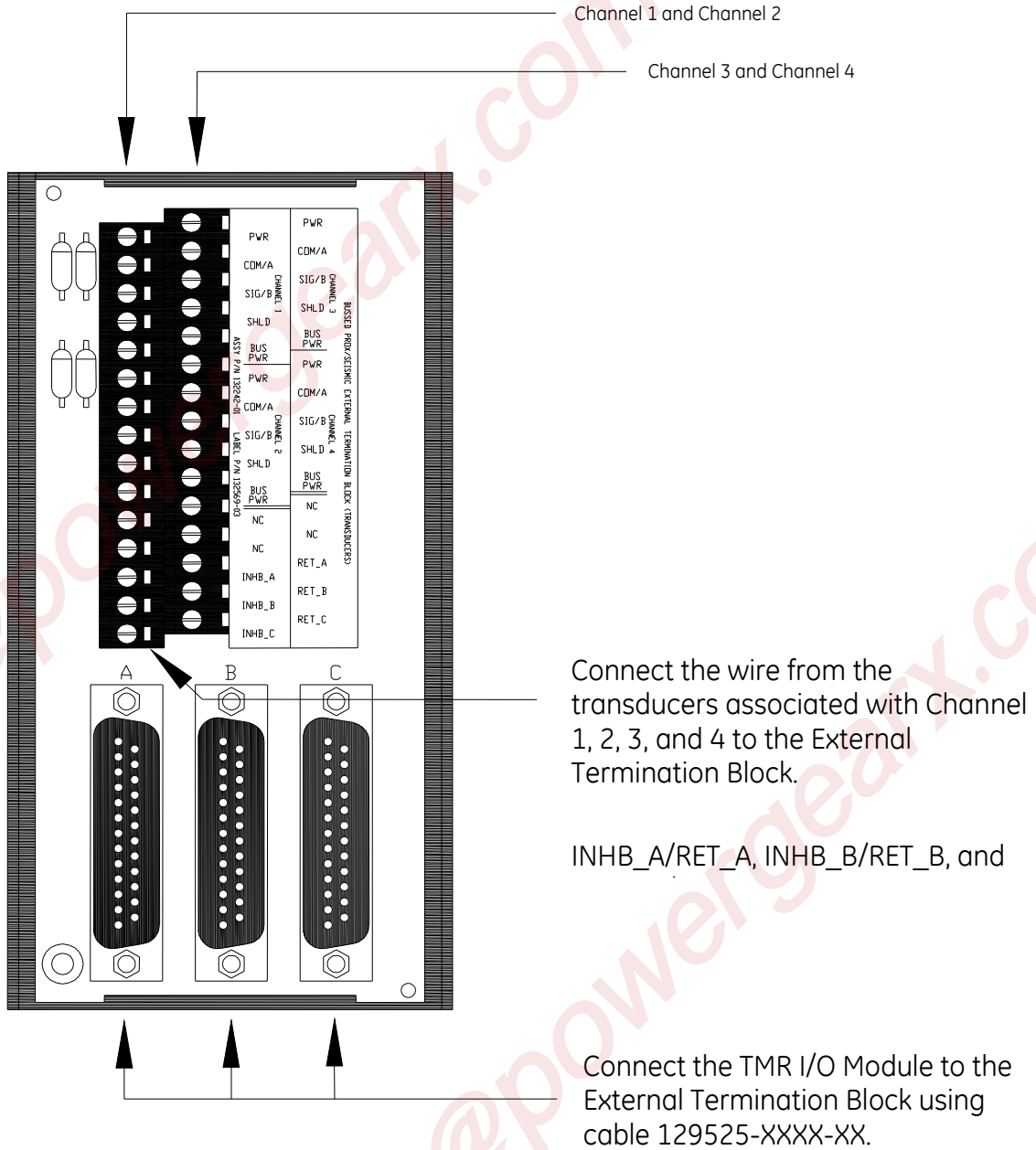

4.5.3.5 Recorder External Termination Block (Terminal Strip connectors)

Connect the recorders associated with Channel 1, 2, 3, and 4 to the Recorder External Termination Block.

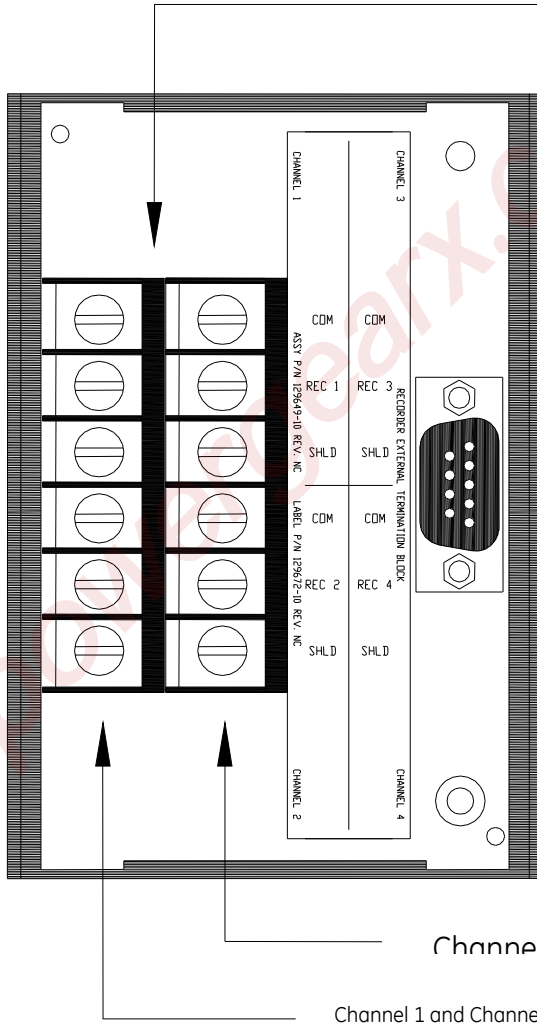

Connect the I/O module to the Recorder External Termination Block using cable 120520-XXXX-XX

4.5.3.6 Recorder External Termination Block (Euro Style connectors)

Connect the recorders associated with Channel 1, 2, 3, and 4 to the Recorder External Termination Block.

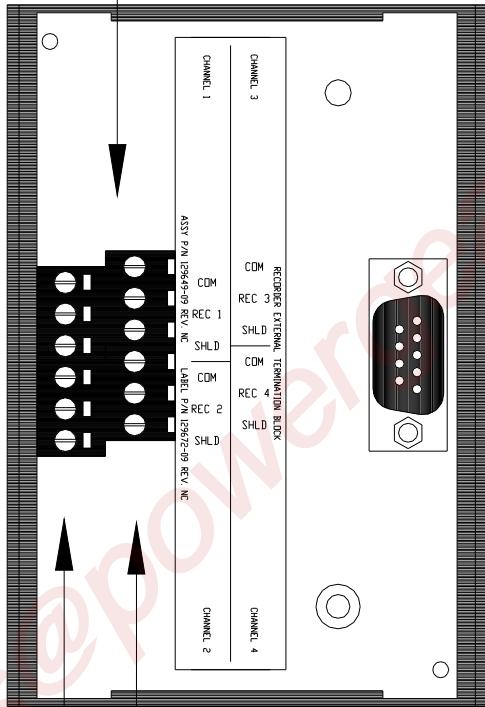

Connect the I/O module to the Recorder External Termination Block.

Channel 3 and Channel 4

Channel 1 and Channel 2

4.5.4 Cable Pin Outs

Cable Number 129525-XXXX-XX

3500 Transducer Signal
to External Termination
Block Cable

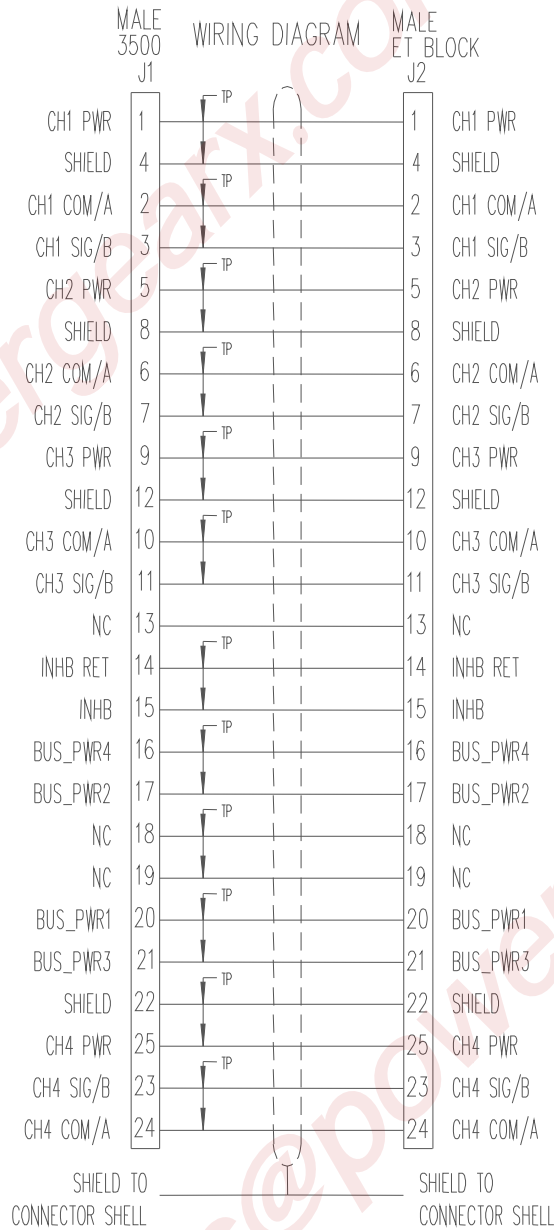

129529-XXXX-XX

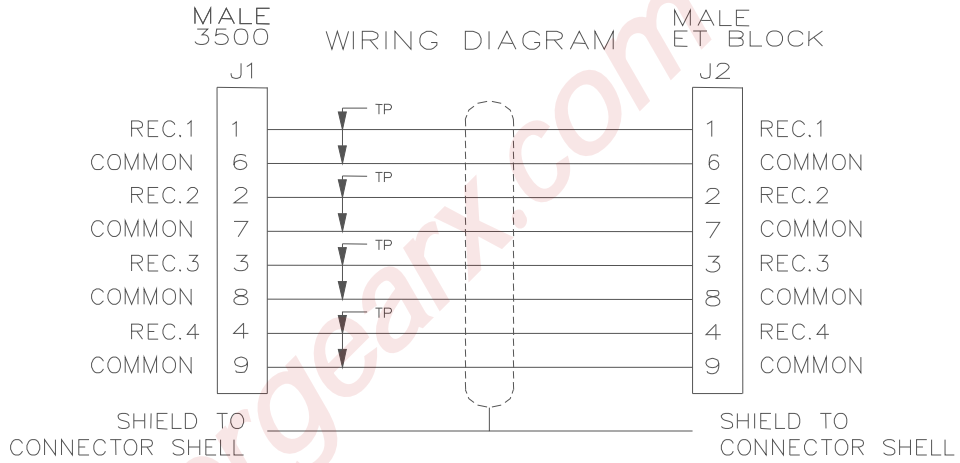

3500 Recorder Output to ET Block Cable

5. Maintenance

The boards and components inside of 3500 modules cannot be repaired in the field. Maintaining a 3500 rack consists of testing module channels to verify that they are operating correctly. Modules that are not operating correctly should be replaced with a spare.

This section shows how to verify the operation of channels in an Proximator®/Seismic Monitor (Section 5.1), how to adjust the scale factor (Section 5.2.1), and zero position (Section 5.2.2).

5.1 Verifying a 3500 Rack - Proximator®/Seismic Monitor Module

The 3500 Monitoring System is a high precision instrument that requires no calibration. The functions of monitor channels, however, must be verified at regular intervals. At each maintenance interval, we recommend that you use the procedures in this section to verify the operation of all active channels in the monitor. It is only necessary to verify the alarms and accuracy of channel proportional values that are active.

Section Number	Topic	Page Number
5.1.1	Choosing a Maintenance Interval	103
5.1.2	Required Test Equipment	103
5.1.3	Typical Verification Test Setup	105
5.1.4	Using the Rack Configuration Software	106
5.1.5	Radial Vibration Channels	110
0	Thrust Position and Differential Expansion Channels	143
5.1.6	Eccentricity Channels	156
5.1.7	Velocity Channels	170
5.1.8	Acceleration Channels	193
5.1.9	Verify Recorder Outputs	208
5.1.10	If a Channel Fails a Verification Test	209

5.1.1 Choosing a Maintenance Interval

Use the following approach to choose a maintenance interval:

Start with an interval of one year and then shorten the interval if any of the following conditions apply:

- the monitored machine is classified as critical.
- the 3500 rack is operating in a harsh environment such as in extreme temperature, high humidity, or in a corrosive atmosphere.

At each interval, use the results of the previous verifications and ISO Procedure 10012-1 to adjust the interval.

5.1.2 Required Test Equipment

The verification procedures in this section require the following test equipment.

Radial Vibration Channels

- Power Supply (single channel)
- Multimeter - 4½ digits
- Function Generator
- 100 µF capacitor
- 40 kΩ resistor
 - Bently Nevada Corporation TK 16 Keyphasor Multiplier/Divider or equivalent (Instructions in this manual refer to the TK 16)
- additional -18 Vdc Supply for use with the TK 16
- 2 Channel Oscilloscope

Thrust Position and Differential Expansion Channels

- Power Supply (single channel)
- Multimeter - 4½ digits

Eccentricity Channels

- Power Supply (single channel)

- Multimeter - 4½ digits
- Function Generator
- 100 µF capacitor
- 40 kΩ resistor

Velocity Channels - Seismoprobe

- Power Supply (single channel)
- Multimeter - 4½ digits
- Function Generator
- 2.49 kΩ resistor

Velocity Channels - Velomitor

- Power Supply (single channel)
- Multimeter - 4½ digits
- Function Generator
- 10 µF capacitor
 - 4 kΩ resistor

Acceleration Channels

- Power Supply (single channel)
- Multimeter - 4½ digits
- Function Generator

5.1.3 Typical Verification Test Setup

The following figure shows the typical test setup for verifying a Proximator®/Seismic Monitor. The test equipment is used to simulate the transducer signal and the laptop computer is used to observe the output from the rack.

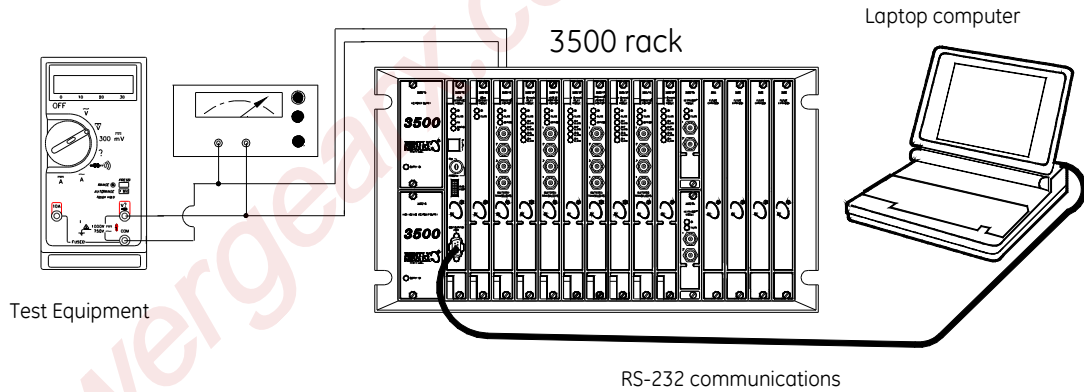

General Layout for Maintenance

Transducers can be connected to a 3500 rack in a variety of ways. Depending on the wiring option for the I/O module of your monitor, connect the test equipment to the monitor using one of the following methods:

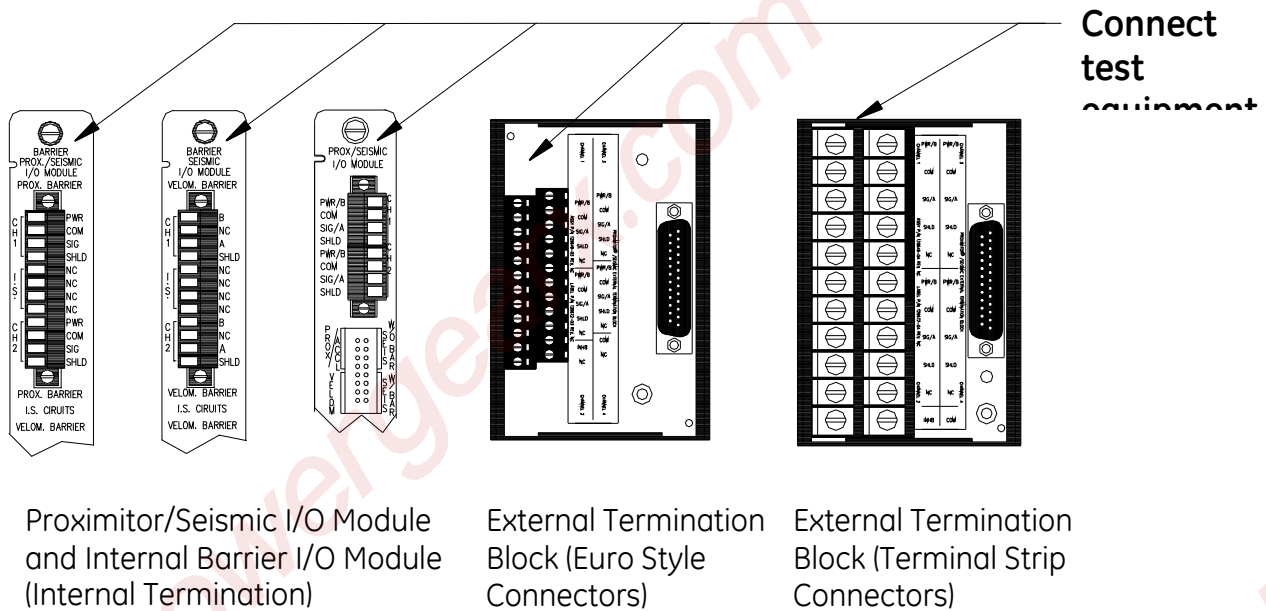

5.1.4 Using the Rack Configuration Software

The laptop computer that is part of the test setup uses the Rack Configuration Software to display output from the rack and to reset certain operating parameters in the rack. To perform the test procedures in this section you must be familiar with the following features of the Rack Configuration Software:

- upload, download, and save configuration files
- enable and disable channels and alarms
- bypass channels and alarms
- display the Verification screen

The Rack Configuration and Test Utilities Guide (part number 129777-01) explains how to perform these operations.

Note

It is important to save the original rack configuration before doing any Maintenance or Troubleshooting Procedures. It may be necessary during these procedures to change setpoints, etc. which must be restored to their original values at the conclusion of the procedures. At that time the original configuration should be downloaded to the rack.

The following figures show how the Verification screen displays output from a 3500 rack:

Alarm Verification Fields:

These fields display output for verifying channel alarms. Alert/Alarm 1 alarms are displayed in yellow in the bar graph and with the word "Alarm" under the current value box. Danger/Alarm 2 alarms are displayed in red in the bar graph and with

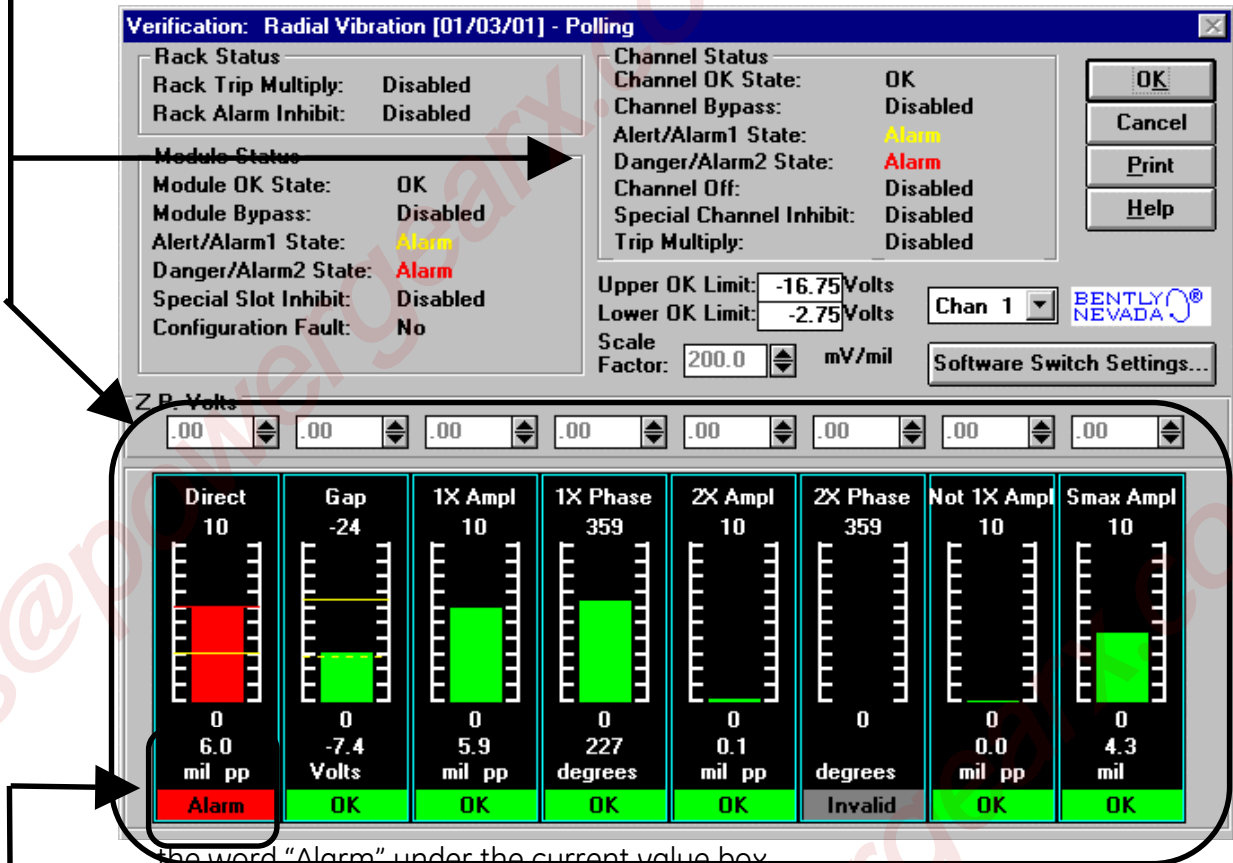

the word "Alarm" under the current value box.



Current Value

The current proportional value is displayed in this box.

Setpoints are indicated by lines on the bargraph display:

Danger/Alarm 2 Over = Solid Red Line

Alert/Alarm 1 Over = Solid Yellow Line

Alert/Alarm 1 Under = Dashed Yellow Line

Danger/Alarm 2 Under = Dashed Red Line

The Zero Position Voltage is the voltage input that will cause the reading on the bar graph display and current value box to be zero. The Zero Position Volts value is displayed in the Zero Position Volts box above each channel value bar graph.

Any channel bar graph value that enters Alert/Alarm 1 or Danger/Alarm 2 will cause the alarm lines in the Channel Status box to indicate an alarm. Any channel that enters alarm will cause the alarm lines in the Module Status box to indicate an alarm.

OK Limit Verification Fields

These fields display output for verifying OK limits.

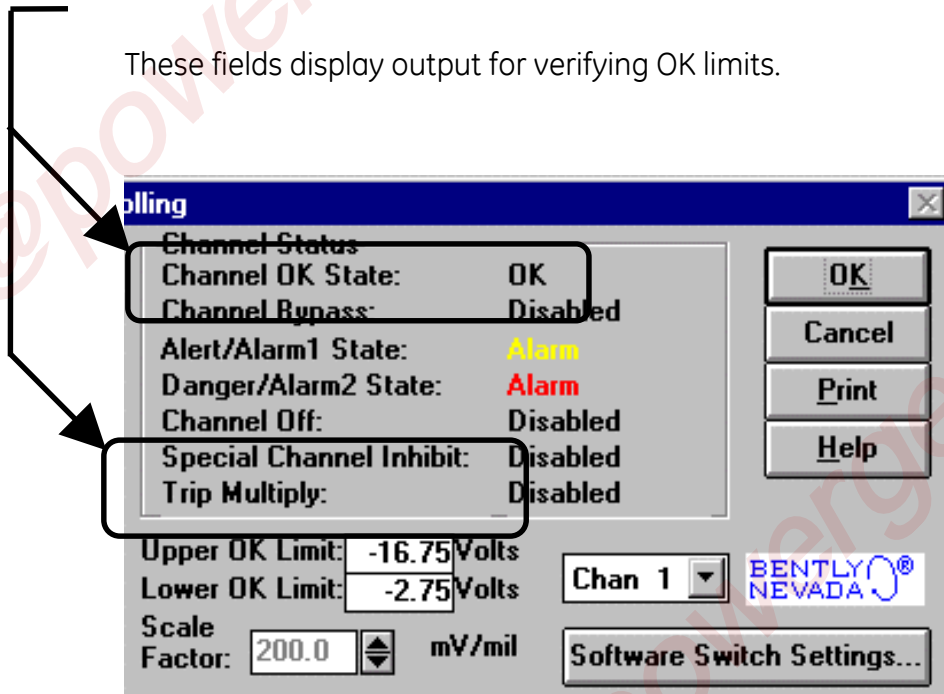

Current Value Verification Fields:

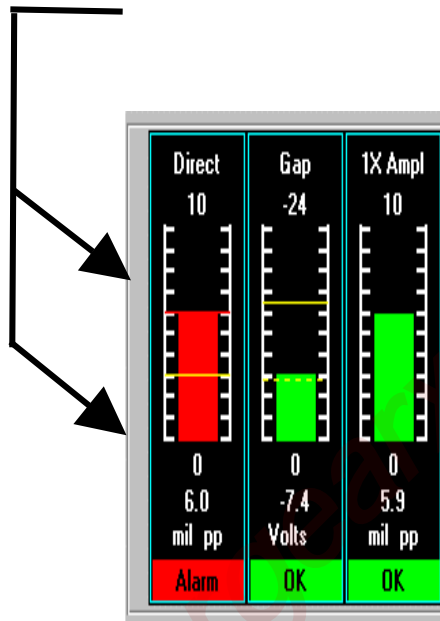

These fields display output for verifying channel output.

5.1.5 Radial Vibration Channels

The following sections describe how to test alarms, verify channels, and test OK limits for channels configured as Radial Vibration. The output values and alarm setpoints are verified by varying the input vibration signal level (both peak to peak amplitude and DC voltage bias) and observing that the correct results are reported in the Verification screen on the test computer.

Radial Vibration channels can be configured for the following channel values and alarms:

Channel Values	Alarms	
	Over	Under
Direct	X	
Gap	X	X
1X Amplitude and Phase	X	X
2X Amplitude and Phase	X	X
Not 1X Amplitude	X	
S _{max} Amplitude	X	

5.1.5.1 Test Equipment and Software Setup - Radial Vibration

The following test equipment and software setup can be used as the initial set up needed for all the Radial Vibration channel verification procedures (Test Alarms, Verify Channels, and Test OK Limits).

Application Alert
Tests will exceed alarm setpoint levels causing alarms to activate. This could result in a relay contact state change.

 WARNING
High voltage present. Contact could cause shock, burns, or death. Do not touch exposed wires or terminals.

Application Alert
Disconnecting the field wiring will cause a not OK condition.

Test Equipment Setup - Radial Vibration

Simulate the transducer signal by connecting the power supply, function generator, and multimeter to COM and SIG of channel 1 with polarity as shown in the figure below (Radial Vibration Test Setup). Set the test equipment as specified below.

Power Supply	Function Generator	Keyphasor Multiplier/Divider
-7.00 Vdc	Waveform: sinewave DC Volts: 0 Vdc Frequency: 100 Hz Amplitude level: Minimum (above zero)	Multiply Switch: 001 Divide Switch: 001

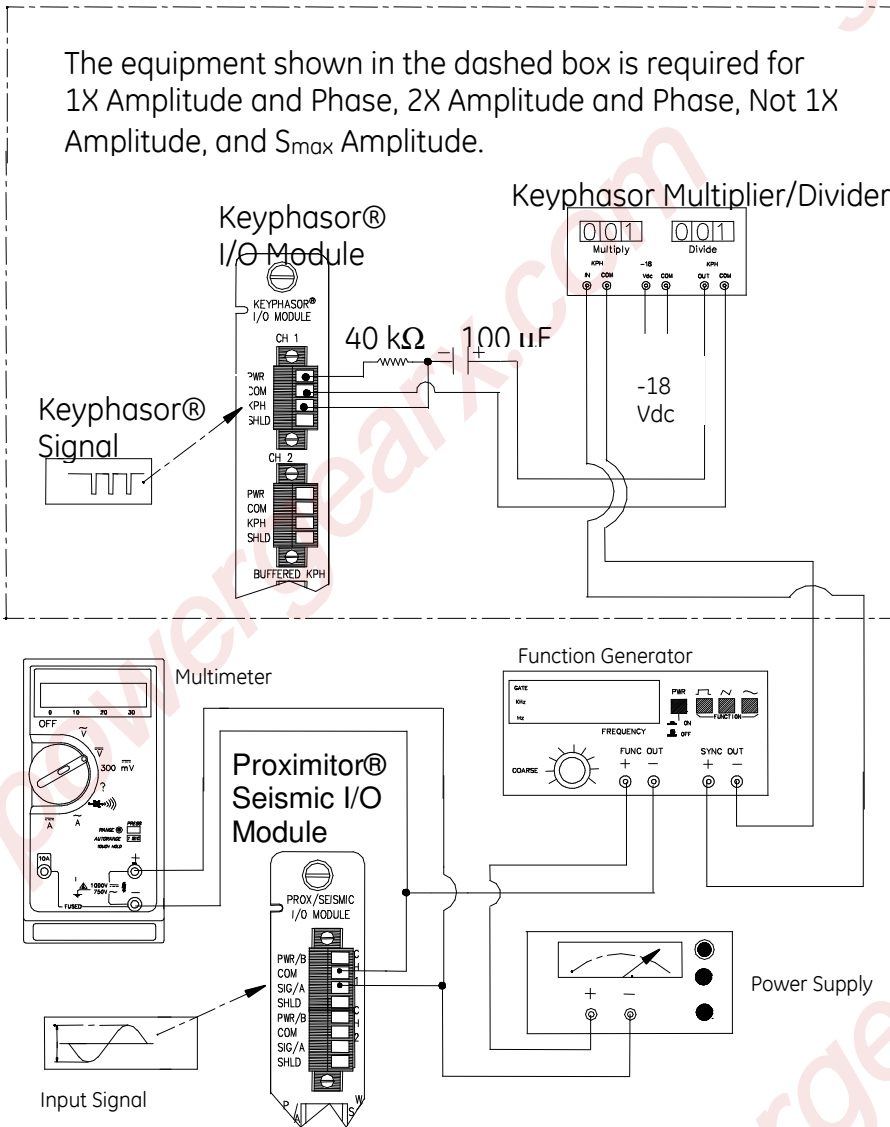

Radial Vibration Test Setup

The Test Equipment outputs should be floating relative to earth ground.

Verification Screen Setup - Radial Vibration

Run the Rack Configuration Software on the test computer. Choose **Verification** from the Utilities menu and choose the proper Slot number and Channel number then click on the **Verify** button.

Note

Timed OK Channel Defeat is enabled for Radial Vibration channels. It will take 30 seconds for a channel to return to the **OK** status from a **not OK** condition.

The following table directs you to the starting page of each maintenance section associated with the Radial Vibration Channels.

Section Number	Topic	Page Number
5.1.5.2	Test Alarms - Direct	115
5.1.5.2	Test Alarms - Gap	116
5.1.5.2	Test Alarms - 1X Amplitude	118
5.1.5.2	Test Alarms - 1X Phase	119
5.1.5.2	Test Alarms - 2X Amplitude	121
5.1.5.2	Test Alarms - 2X Phase	122
5.1.5.2	Test Alarms - Not 1X Amplitude	124
5.1.5.2	Test Alarms - S_{max} Amplitude	125
5.1.5.3	Verify Channel Values - Direct	127
5.1.5.3	Verify Channel Values - Gap	128
5.1.5.3	Verify Channel Values - 1X Amplitude	131
5.1.5.3	Verify Channel Values - 1X Phase	132
5.1.5.3	Verify Channel Values - 2X Amplitude	134
5.1.5.3	Verify Channel Values - 2X Phase	136
5.1.5.3	Verify Channel Values - Not 1X Amplitude	138
5.1.5.3	Verify Channel Values - S_{max} Amplitude	139
5.1.5.4	Test OK Limits	141

5.1.5.2 Test Alarms - Radial Vibration

The general approach for testing alarm setpoints is to simulate the vibration and Keyphasor® signal with a function generator. The alarm levels are tested by varying the vibration signal (both peak to peak amplitude and DC voltage bias) and observing that the correct results are reported in the Verification screen on the test computer. It is only necessary to test those alarm parameters that are configured and being used. The general test procedure to verify current alarm operation will include simulating a transducer input signal and varying this signal:

1. to exceed over Alert/Alarm 1 and Danger/Alarm 2 Setpoints, and
2. to drop below any under Alert/Alarm 1 and Danger/Alarm 2 Setpoints and
3. to produce a nonalarm condition.

When varying the signal from an alarm condition to a nonalarm condition, alarm hysteresis must be considered. Adjust the signal well below the alarm setpoint for the alarm to clear.

Direct

1. Disconnect PWR, COM, and SIG field wiring from the channel terminals on the I/O module.
2. Connect test equipment and run software as described in Section 5.1.5.1 (Test Equipment and Software Setup - Radial Vibration).
3. Set the Keyphasor multiplier/divider so that the multiply setting is one and the divide setting is one. Adjust the function generator amplitude to produce a reading that is below the Direct setpoint levels on the Direct bar graph display of the Verification screen.
4. Press the RESET switch on the Rack Interface Module (RIM). Verify that the OK LED is on, the bar graph indicator for Direct is green, and the Current Value field contains no alarm indication.
5. Adjust the function generator amplitude such that the signal just exceeds the Direct Over Alert/Alarm 1 setpoint level. Wait for 2 or 3 seconds after the alarm time delay expires and verify that the bar graph indicator for Direct changes color from green to yellow and that the Current Value Field indicates an Alarm.

6. Press the RESET switch on the Rack Interface Module (RIM). Verify that the bar graph indicator for Direct remains yellow and that the Current Value Field still indicates an Alarm.
7. Adjust the function generator amplitude such that the signal just exceeds the Direct Over Danger/Alarm 2 setpoint level. Wait for 2 or 3 seconds after the alarm time delay expires and verify that the bar graph indicator for Direct changes color from yellow to red and that the Current Value Field indicates an Alarm.
8. Press the RESET switch on the Rack Interface Module (RIM). Verify that the bar graph indicator for Direct remains red and that the Current Value Field still indicates an Alarm.
9. Adjust the function generator amplitude such that the signal reads below the Over Alarm setpoint levels. If the nonlatching option is configured, observe that the bar graph indicator for Direct changes color to green and that the Current Value Box contains no indication of alarms. Press the RESET switch on the Rack Interface Module (RIM) to reset latching alarms.
10. If you can't verify any configured alarm, recheck the configured setpoints. If the monitor still does not alarm properly or fails any other part of this test, go to Section 5.1.10 (If a Channel Fails a Verification Test).
11. Disconnect the test equipment and reconnect the PWR, COM, and SIG field wiring to the channel terminals on the I/O module. Verify that the OK LED comes on and the OK relay energizes. Press the RESET switch on the Rack Interface Module (RIM) to reset the OK LED.
12. Repeat steps 1 through 11 for all configured channels.

Gap

1. Disconnect PWR, COM, and SIG field wiring from the channel terminals on the I/O module.
2. Connect test equipment and run software as described in Section 5.1.5.1 (Test Equipment and Software Setup - Radial Vibration).
3. Adjust the power supply to produce a voltage that is within the Gap setpoint levels on the Gap bar graph display of the Verification screen.

4. Press the RESET switch on the Rack Interface Module (RIM). Verify that the OK LED is on, the bar graph indicator for Gap is green and that the Current Value field has no alarm indication.
5. Adjust the power supply voltage such that the signal just exceeds the Gap Over Alert/Alarm 1 setpoint level. Wait for 2 or 3 seconds after the alarm time delay expires and verify that the bar graph indicator for Gap changes color from green to yellow and that the Current Value Field indicates an Alarm.
6. Press the RESET switch on the Rack Interface Module (RIM). Verify that the bar graph indicator for Gap remains yellow and that the Current Value Field still indicates an Alarm.
7. Adjust the power supply such that the signal just exceeds the Gap Over Danger/Alarm 2 setpoint level. Wait for 2 or 3 seconds after the alarm time delay expires and verify that the bar graph indicator for Gap changes color from yellow to red and that the Current Value Field indicates an Alarm.
8. Press the RESET switch on the Rack Interface Module (RIM). Verify that the bar graph indicator for Gap remains red and that the Current Value Field still indicates an Alarm.
9. Adjust the power supply voltage such that the signal reads below the Over Alarm setpoint levels. If the nonlatching option is configured, observe that the bar graph indicator for Gap changes color to green and that the Current Value Box contains no indication of alarms. Press the RESET switch on the Rack Interface Module (RIM) to reset latching alarms.
10. Repeat steps 5 through 9 to test the Under Alert/Alarm 1 and Under Danger/Alarm 2 setpoints by adjusting the power supply to exceed the Under Alarm setpoint levels.
11. If you can not verify any configured alarm, recheck the configured setpoints. If the monitor still does not alarm properly or fails any other part of this test, go to Section 5.1.10 (If a Channel Fails a Verification Test).
12. Disconnect the test equipment and reconnect the PWR, COM, and SIG field wiring to the channel terminals on the I/O module. Verify that the OK LED comes on and the OK relay energizes. Press the RESET switch on the Rack Interface Module (RIM) to reset the OK LED.

13. Repeat steps 1 through 12 for all configured channels.

1X Amplitude (1X Ampl)

Note

The Keyphasor must be triggering and have a valid rpm value to check this parameter.

1. Disconnect PWR, COM, and SIG field wiring from the channel terminals on the I/O module.
2. Connect test equipment and run software as described in Section 5.1.5.1 (Test Equipment and Software Setup - Radial Vibration).
3. Set the Keyphasor multiplier/divider so that the multiply setting is one and the divide setting is one. Adjust the function generator amplitude to produce a reading that is within the 1X Ampl setpoint levels on the 1X Ampl bar graph display of the Verification screen.
4. Press the RESET switch on the Rack Interface Module (RIM). Verify that the OK LED is on, the bar graph indicator for 1X Ampl is green and that the Current Value field contains no alarm indication.
5. Adjust the function generator amplitude such that the signal just exceeds the 1X Ampl Over Alert/Alarm 1 setpoint level. Wait for 2 to 3 seconds after the alarm time delay expires and verify that the bar graph indicator for 1X Ampl changes color from green to yellow and the Current Value Field indicates an Alarm.
6. Press the RESET switch on the Rack Interface Module (RIM). Verify that the bar graph indicator for 1X Ampl remains yellow and that the Current Value Field still indicates an Alarm.
7. Adjust the function generator amplitude such that the signal just exceeds the 1X Ampl Over Danger/Alarm 2 setpoint level. Wait for 2 to 3 seconds after the alarm time delay expires and verify that the bar graph indicator for 1X Ampl changes color from yellow to red and the Current Value Field indicates an Alarm.
8. Press the RESET switch on the Rack Interface Module (RIM). Verify that the bar graph indicator for 1X Ampl remains red and that the Current Value Field still indicates an Alarm.

9. Adjust the function generator amplitude such that the signal reads below the Over Alarm setpoint levels. If the nonlatching option is configured, observe that the bar graph indicator for 1X Ampl changes color to green and that the Current Value Box contains no indication of alarms. Press the RESET switch on the Rack Interface Module (RIM) to reset latching alarms.
10. Repeat steps 3 through 9 to test the Under Alert/Alarm 1 and Under Danger/Alarm 2 setpoints by adjusting the function generator amplitude to exceed the Under Alarm setpoint levels.
11. If you can not verify any configured alarm, recheck the configured setpoints. If the monitor still does not alarm properly or fails any other part of this test, go to Section 5.1.10 (If a Channel Fails a Verification Test).
12. Disconnect the test equipment and reconnect the PWR, COM, and SIG field wiring to the channel terminals on the I/O module. Verify that the OK LED comes on and the OK relay energizes. Press the RESET switch on the Rack Interface Module (RIM) to reset the OK LED.
13. Repeat steps 1 through 12 for all configured channels.

1X Phase

1. Disconnect PWR, COM, and SIG field wiring from the channel terminals on the I/O module.
2. Connect test equipment and run software as described in Section 5.1.5.1 (Test Equipment and Software Setup - Radial Vibration).

Note

If you can not change the phase output, change the phase alarm setpoints to activate the over and under phase alarms. The setpoints must be downloaded to the monitor to take effect.

3. Set the Keyphasor multiplier/divider so that the multiply setting is one and the divide setting is one. Adjust the phase to produce a reading that is within the 1X Phase setpoint levels on the 1X Phase bar graph display of the Verification screen.

Note

The 1X Amplitude needs to be a minimum of 100 mV to get a valid 1X Phase reading.

4. Press the RESET switch on the Rack Interface Module (RIM). Verify that the OK LED is on, the bar graph indicator for 1X Phase is green, and the Current Value field contains no alarm indication.
5. Adjust the phase such that the reading just exceeds the 1X Phase Over Alert/Alarm 1 setpoint level. Wait for 2 or 3 seconds after the alarm time delay expires and verify that the bar graph indicator for 1X Phase changes color from green to yellow and the Current Value Field indicates an Alarm.
6. Press the RESET switch on the Rack Interface Module (RIM). Verify that the bar graph indicator for 1X Phase remains yellow and that the Current Value Field still indicates an Alarm.
7. Adjust the phase such that the reading just exceeds the 1X Phase Over Danger/Alarm 2 setpoint level. Wait for 2 or 3 seconds after the alarm time delay expires and verify that the bar graph indicator for 1X Phase changes color from yellow to red and that the Current Value Field indicates an Alarm.
8. Press the RESET switch on the Rack Interface Module (RIM). Verify that the bar graph indicator for 1X Phase remains red and that the Current Value Field still indicates an Alarm.
9. Adjust the phase such that the reading is below the Over Alarm setpoint levels. If the nonlatching option is configured, observe that the bar graph indicator for 1X Phase changes color to green and that the Current Value Box contains no indication of alarms. Press the RESET switch on the Rack Interface Module (RIM) to reset latching alarms.
10. Repeat steps 3 through 9 to test the Under Alert/Alarm 1 and Under Danger/Alarm 2 setpoints by adjusting the phase to exceed the Under Alarm setpoint levels.
11. If you can not verify any configured alarm, recheck the configured setpoints. If the monitor still does not alarm properly or fails any other part of this test, go to Section 5.1.10 (If a Channel Fails a Verification Test).
12. Disconnect the test equipment and reconnect the PWR, COM, and SIG field wiring to the channel terminals on the I/O module. Verify that the OK LED comes on and the OK relay energizes. Press the RESET switch on the Rack Interface Module (RIM) to reset the OK LED.

13. Repeat steps 1 through 12 for all configured channels.

2X Amplitude (2X Ampl)

Note

The Keyphasor must be triggering and have a valid rpm value to check this parameter.

1. Disconnect PWR, COM, and SIG field wiring from the channel terminals on the I/O module.
2. Connect test equipment and run software as described in Section 5.1.5.1 (Test Equipment and Software Setup - Radial Vibration).
3. Set the Keyphasor multiplier/divider so that the multiply setting is one and the divide setting is two. Adjust the function generator amplitude to produce a reading that is within the 2X Ampl setpoint levels on the 2X Ampl bar graph display of the Verification screen.
4. Press the RESET switch on the Rack Interface Module (RIM). Verify that the OK LED is on, the bar graph indicator for 2X Ampl is green, and the Current Value field has no alarm indication.
5. Adjust the function generator amplitude such that the signal just exceeds the 2X Ampl Over Alert/Alarm 1 setpoint level. Wait 2 or 3 seconds after the alarm time delay expires and verify that the bar graph indicator for 2X Ampl changes color from green to yellow and that the Current Value Field indicates an Alarm.
6. Press the RESET switch on the Rack Interface Module (RIM). Verify that the bar graph indicator for 2X Ampl remains yellow and that the Current Value Field still indicates an Alarm.
7. Adjust the function generator amplitude such that the signal just exceeds the 2X Ampl Over Danger/Alarm 2 setpoint level. Wait for 2 or 3 seconds after the alarm time delay expires and verify that the bar graph indicator for 2X Ampl changes color from yellow to red and that the Current Value Field indicates an Alarm.
8. Press the RESET switch on the Rack Interface Module (RIM). Verify that the bar graph indicator for 2X Ampl remains red and that the Current Value Field still indicates an Alarm.

9. Adjust the function generator amplitude such that the signal reads below the Over Alarm setpoint levels. If the nonlatching option is configured, observe that the bar graph indicator for 2X Ampl changes color to green and that the Current Value Box contains no indication of alarms. Press the RESET switch on the Rack Interface Module (RIM) to reset latching alarms.
10. Repeat steps 3 through 9 to test the Under Alert/Alarm 1 and Under Danger/Alarm 2 setpoints by adjusting the function generator amplitude to exceed the Under Alarm setpoint levels.
11. If you can not verify any configured alarm, recheck the configured setpoints. If the monitor still does not alarm properly or fails any other part of this test, go to Section 5.1.10 (If a Channel Fails a Verification Test).
12. Disconnect the test equipment and reconnect the PWR, COM, and SIG field wiring to the channel terminals on the I/O module. Verify that the OK LED comes on and the OK relay energizes. Press the RESET switch on the Rack Interface Module (RIM) to reset the OK LED.
13. Repeat steps 1 through 12 for all configured channels.

2X Phase

1. Disconnect PWR, COM, and SIG field wiring from the channel terminals on the I/O module.
2. Connect test equipment and run software as described in Section 5.1.5.1 (Test Equipment and Software Setup - Radial Vibration).

Note

If you can not change the phase output, change the phase alarm setpoints to activate the over and under phase alarms. The setpoints must be downloaded to the monitor to take effect.

3. Set the Keyphasor multiplier/divider so that the multiply setting is one and the divide setting is two. Adjust the phase to produce a reading that is within the 2X Phase setpoint levels on the 2X Phase bar graph display of the Verification screen.

Note

The 2X Amplitude needs to be a minimum of 100 mV to get a valid 2X Phase reading.

4. Press the RESET switch on the Rack Interface Module (RIM). Verify that the

OK LED is on, the bar graph indicator for 2X Phase is green, and the Current Value field has no alarm indication.

5. Adjust the phase such that the reading just exceeds the 2X Phase Over Alert/Alarm 1 setpoint level. Wait for 2 or 3 seconds after the alarm time delay and verify that the bar graph indicator for 2X Phase changes color from green to yellow and that the Current Value Field indicates an Alarm.
6. Press the RESET switch on the Rack Interface Module (RIM). Verify that the bar graph indicator for 2X Phase remains yellow and that the Current Value Field still indicates an Alarm.
7. Adjust the phase such that the reading just exceeds the 2X Phase Over Danger/Alarm 2 setpoint level. Wait for 2 or 3 seconds after the alarm time delay expires and verify that the bar graph indicator for 2X Phase changes color from yellow to red and that the Current Value Field indicates an Alarm.
8. Press the RESET switch on the Rack Interface Module (RIM). Verify that the bar graph indicator for 2X Phase remains red and that the Current Value Field still indicates an Alarm.
9. Adjust the phase such that the reading is below the Over Alarm setpoint levels. If the nonlatching option is configured, observe that the bar graph indicator for 2X Phase changes color to green and that the Current Value Box contains no indication of alarms. Press the RESET switch on the Rack Interface Module (RIM) to reset latching alarms.
10. Repeat steps 3 through 9 to test the Under Alert/Alarm 1 and Under Danger/Alarm 2 setpoints by adjusting the phase to exceed the Under Alarm setpoint levels.
11. If you can not verify any configured alarm, recheck the configured setpoints. If the monitor still does not alarm properly or fails any other part of this test, go to Section 5.1.10 (If a Channel Fails a Verification Test).
12. Disconnect the test equipment and reconnect the PWR, COM, and SIG field wiring to the channel terminals on the I/O module. Verify that the OK LED comes on and the OK relay energizes. Press the RESET switch on the Rack Interface Module (RIM) to reset the OK LED.
13. Repeat steps 1 through 12 for all configured channels.

Not 1X Amplitude (Not 1X)

Note

The Keyphasor must be triggering and have a valid rpm value to check this parameter.

1. Disconnect PWR, COM, and SIG field wiring from the channel terminals on the I/O module.
2. Connect test equipment and run software as described in Section 5.1.5.1 (Test Equipment and Software Setup - Radial Vibration).
3. Set the Keyphasor multiplier/divider so that the multiply setting is one and the divide setting is two. Adjust the function generator amplitude to produce a reading that is below the Not 1X setpoint levels on the Not 1X bar graph display of the Verification screen.
4. Press the RESET switch on the Rack Interface Module (RIM). Verify that the OK LED is on, the bar graph indicator for Not 1X is green, and the Current Value field has no alarm indication.
5. Adjust the function generator amplitude such that the signal just exceeds the Not 1X Over Alert/Alarm 1 setpoint level. Wait for 2 or 3 seconds after the alarm time delay expires and verify that the bar graph indicator for Not 1X changes color from green to yellow and that the Current Value Field indicates an Alarm.
6. Press the RESET switch on the Rack Interface Module (RIM). Verify that the bar graph indicator for Not 1X remains yellow and that the Current Value Field still indicates an Alarm.
7. Adjust the function generator amplitude such that the signal just exceeds the Not 1X Over Danger/Alarm 2 setpoint level. Wait for 2 or 3 seconds after the alarm time delay expires and verify that the bar graph indicator for Not 1X changes color from yellow to red and that the Current Value Field indicates an Alarm.
8. Press the RESET switch on the Rack Interface Module (RIM). Verify that the bar graph indicator for Not 1X remains red and that the Current Value Field still indicates an Alarm.
9. Adjust the function generator amplitude such that the signal reads below the Over Alarm setpoint levels. If the nonlatching option is configured,

observe that the bar graph indicator for Not 1X changes color to green and the Current Value Box contains no indication of alarms. Press the RESET switch on the Rack Interface Module (RIM) to reset latching alarms.

10. If you can not verify any configured alarm, recheck the configured setpoints. If the monitor still does not alarm properly or fails any other part of this test, go to Section 5.1.10 (If a Channel Fails a Verification Test).
11. Disconnect the test equipment and reconnect the PWR, COM, and SIG field wiring to the channel terminals on the I/O module. Verify that the OK LED comes on and the OK relay energizes. Press the RESET switch on the Rack Interface Module (RIM) to reset the OK LED.
12. Repeat steps 1 through 11 for all configured channels.

S_{max} Amplitude

Note

The Keyphasor must be triggering and have a valid rpm value to check this parameter.

1. Disconnect PWR, COM, and SIG field wiring from the channel pair terminals on the I/O module.
2. Connect test equipment and run software as described in Section 5.1.5.1 (Test Equipment and Software Setup - Radial Vibration). **S_{max} requires input connections to both channel 1 and 2 or channel 3 and 4.**
3. Adjust the function generator amplitude to produce a reading that is below the S_{max} setpoint levels on the S_{max} bar graph display of the Verification screen.
4. Press the RESET switch on the Rack Interface Module (RIM). Verify that the OK LED is on, the bar graph indicator for S_{max} is green, and the Current Value field has no alarm indication.
5. Adjust the function generator amplitude such that the signal just exceeds the S_{max} Over Alert/Alarm 1 setpoint level. Wait for 2 or 3 seconds after the alarm time delay expires and verify that the bar graph indicator for S_{max} changes color from green to yellow and that the Current Value Field indicates an Alarm.

6. Press the RESET switch on the Rack Interface Module (RIM). Verify that the bar graph indicator for S_{max} remains yellow and that the Current Value Field still indicates an Alarm.
7. Adjust the function generator amplitude such that the signal just exceeds the S_{max} Over Danger/Alarm 2 setpoint level. Wait for 2 or 3 seconds after the alarm time delay expires and verify that the bar graph indicator for S_{max} changes color from yellow to red and that the Current Value Field indicates an Alarm.
8. Press the RESET switch on the Rack Interface Module (RIM). Verify that the bar graph indicator for S_{max} remains red and that the Current Value Field still indicates an Alarm.
9. Adjust the function generator amplitude such that the signal reads below the Over Alarm setpoint levels. If the nonlatching option is configured, observe that the bar graph indicator for S_{max} changes color to green and the Current Value Box contains no indication of alarms. Press the RESET switch on the Rack Interface Module (RIM) to reset latching alarms.
10. If you can not verify any configured alarm, recheck the configured setpoints. If the monitor still does not alarm properly or fails any other part of this test, go to Section 5.1.10 (If a Channel Fails a Verification Test).
11. Disconnect the test equipment and reconnect the PWR, COM, and SIG field wiring to the channel pair terminals on the I/O module. Verify that the OK LED comes on and the OK relay energizes. Press the RESET switch on the Rack Interface Module (RIM) to reset the OK LED.
12. Repeat steps 1 through 11 for all configured channels.

5.1.5.3 Verify Channel Values - Radial Vibration

The general approach for testing channel values is to simulate the vibration and Keyphasor input signal with a function generator. The output values are verified by varying the input vibration signal level (both peak to peak amplitude and DC voltage bias) and observing that the correct results are reported in the Verification screen on the test computer.

Note

These parameters have an accuracy specification of $\pm 1\%$ of full scale for amplitude and ± 3 degrees for phase.

Direct

1. Disconnect PWR, COM, and SIG field wiring from the channel terminals on the I/O module.
2. Connect test equipment and run software as described in Section 5.1.5.1 (Test Equipment and Software Setup - Radial Vibration).
3. Calculate the full-scale voltage according to the equation and examples shown below. Adjust the amplitude of the function generator to the calculated voltage.

$$\text{Full Scale Voltage} = \text{Direct Meter Top Scale} \times \text{Transducer Scale Factor}$$

Note

Use the Transducer Scale Factor displayed in the Scale Factor Box on the Verification Screen.

Example 1:

Direct Meter Top Scale = 10 mil

Transducer Scale Factor = 200 mV/mil

$$\begin{aligned} \text{Full Scale} &= (10 \times 0.200) \\ &= 2.000 \text{ Vpp} \end{aligned}$$

For V_{rms} input:

$$\begin{aligned} V_{\text{rms}} &= (0.707/2) \times (V_{\text{pp}}), \text{ for a sinewave input} \\ &= (0.707/2) \times (2) \\ &= 0.707 \text{ Vrms} \end{aligned}$$

Example 2:

Direct Meter Top Scale = 200 μm

Transducer Scale Factor = 7,874 mV/mm

= 7.874 mV/ μm

Full Scale = (200 \times 0.007874)

= 1.5748 Vpp

For Vrms input:

Vrms = (0.707/2) \times (Vpp), for a sinewave input

= (0.707/2) \times (1.574)

= 0.5566 Vrms

4. Set the Keyphasor multiplier/divider so that the multiply setting is one and the divide setting is one. Verify that the Direct bar graph display and Current Value Box is reading $\pm 1\%$ of full scale. If the recorder output is configured, refer to Section 5.1.9 (Verify Recorder Outputs) for steps to verify the recorder output.
5. If the reading does not meet specifications, check that the input signal is correct. If the monitor still does not meet specifications or fails any other part of this test, go to Section 5.1.10 (If a Channel Fails a Verification Test).
6. Disconnect the test equipment and reconnect the PWR, COM, and SIG field wiring to the channel terminals on the I/O module. Verify that the OK LED comes on and the OK relay energizes. Press the RESET switch on the Rack Interface Module (RIM) to reset the OK LED.
7. Repeat steps 1 through 6 for all configured channels.

Gap

1. Disconnect PWR, COM, and SIG field wiring from the channel terminals on the I/O module.
2. Connect test equipment and run software as described in Section 5.1.5.1 (Test Equipment and Software Setup - Radial Vibration).
3. **If Gap is configured to read in volts**, adjust the power supply to produce a voltage equal to -18.00 Vdc on the Gap bar graph display. Verify that the

Gap bar graph display and Current Value Box is reading $\pm 1\%$ of -18.00 Vdc. If the recorder output is configured, Refer to Section 5.1.9 (Verify Recorder Outputs) for steps to verify recorder output.

4. Adjust the power supply to produce a voltage equal to mid-scale on the Gap bar graph display. Verify that the Gap bar graph display and Current Value Box is reading $\pm 1\%$ of the mid-scale value. If the recorder output is configured, refer to Section 5.1.9 (Verify Recorder Outputs) for steps to verify the recorder output. Go to step 8.

If Gap is configured to read in displacement units, calculate the full-scale and bottom-scale voltage using the following equation:

Note

Use the Transducer Scale Factor displayed in the Scale Factor Box on the Verification Screen.

Gap Full-Scale =

Gap Zero Position Volts + (Gap Meter Top Scale \times Transducer Scale Factor)

Example 1:

Transducer Scale Factor = 200 mV/mil

Scale Range is 15-0-15 mil (Gap Top Scale = 15 mil)

Gap Zero Position Volts = -9.75 Vdc

$$\begin{aligned}\text{Gap Full Scale input} &= -9.75 \text{ Vdc} + (15 \times 0.200) \\ &= -6.75 \text{ Vdc}\end{aligned}$$

Example 2:

Transducer Scale Factor = 7,874 mV/mm

$$= 7.874 \text{ mV}/\mu\text{m}$$

Scale Range is 300-0-300 μm (Gap Top Scale = 300 μm)

Gap Zero Position Volts = -9.75 Vdc

$$\begin{aligned}\text{Gap Full Scale input} &= -9.75 \text{ Vdc} + (300 \times 0.007874) \\ &= -7.3878 \text{ Vdc}\end{aligned}$$

Gap Bottom-Scale =

Gap Zero Position Volts - (Gap Meter Bottom Scale \times Transducer Scale Factor)

Example 1:

Transducer Scale Factor = 200 mV/mil

Scale Range is 15-0-15 mil (Gap Bottom Scale = 15 mil)

Gap Zero Position Volts = -9.75 Vdc

$$\begin{aligned}\text{Gap Bottom Scale input} &= -9.75 \text{ Vdc} - (15 \times 0.200) \\ &= -12.75 \text{ Vdc}\end{aligned}$$

Example 2:

Transducer Scale Factor = 7,874 mV/mm

= 7.874 mV/ μ m

Scale Range is 300-0-300 μ m (Gap Bottom Scale = 300 μ m)

Gap Zero Position Volts = -9.75 Vdc

$$\begin{aligned}\text{Gap Bottom Scale input} &= -9.75 \text{ Vdc} - (300 \times 0.007874) \\ &= -12.1122 \text{ Vdc}\end{aligned}$$

5. Adjust the power supply voltage to match the voltage displayed in the Gap Zero Position Volts Box. The Gap bar graph display and Current Value Box should read 0 mil (0 mm) \pm 1 %.
6. Adjust the power supply to produce a voltage equal to top scale (from step 3) on the Gap bar graph display. Verify that the Gap bar graph display and Current Value Box is reading \pm 1 % of top scale. If the recorder output is configured, refer to Section 5.1.9 (Verify Recorder Outputs) for steps to verify recorder output.
7. Adjust the power supply to produce a voltage equal to bottom scale (from step 3) on the Gap bar graph display. Verify that the Gap bar graph display and Current Value Box is reading \pm 1 % of bottom scale. If the recorder output is configured, refer to Section 5.1.9 (Verify Recorder Outputs) for steps to verify recorder output.
8. If the reading does not meet specifications, check that the input signal is correct. If the monitor still does not meet specifications or fails any other part of this test, go to Section 5.1.10 (If a Channel Fails a Verification Test).
9. Disconnect the test equipment and reconnect the PWR, COM, and SIG field wiring to the channel terminals on the I/O module. Verify that the OK LED comes on and the OK relay energizes. Press the RESET switch on the Rack

Interface Module (RIM) to reset the OK LED.

10. Repeat steps 1 through 9 for all configured channels.

1X Amplitude (1X Ampl)

Note

The Keyphasor must be triggering and have a valid rpm value to check this parameter.

1. Disconnect PWR, COM, and SIG field wiring from the channel terminals on the I/O module.
2. Connect test equipment and run software as described in Section 5.1.5.1 (Test Equipment and Software Setup - Radial Vibration).
3. Calculate the full-scale voltage according to the equation and examples shown below. Adjust the function generator amplitude to the calculated voltage.

Full Scale Voltage = 1X Ampl Meter Top Scale X Transducer Scale Factor

Note

Use the Transducer Scale Factor displayed in the Scale Factor Box on the Verification Screen.

Example 1:

1X Ampl Meter Top Scale = 10 mil

Transducer Scale Factor = 200 mV/mil

Full Scale = (10 × 0.200)
= 2.000 Vpp

For V_{rms} input:

V_{rms} = (0.707/2) × (Vpp), for a sinewave input
= (0.707/2) × (2)
= 0.707 V_{rms}

Example 2:

1X Ampl Meter Top Scale = 200 μm

$$\begin{aligned}\text{Transducer Scale Factor} &= 7,874 \text{ mV/mm} \\ &= 7.874 \text{ mV}/\mu\text{m} \\ \text{Full Scale} &= (200 \times 0.007874) \\ &= 1.5748 \text{ Vpp}\end{aligned}$$

For V_{rms} input:

$$\begin{aligned}V_{\text{rms}} &= (0.707/2) \times (V_{\text{pp}}), \text{ for a sine wave input} \\ &= (0.707/2) \times (1.574) \\ &= 0.5566 \text{ Vrms}\end{aligned}$$

4. Set the Keyphasor multiplier/divider so that the multiply setting is one and the divide setting is one. Verify that the 1X Ampl bar graph display and Current Value Box is reading $\pm 1\%$ of full scale. If the recorder output is configured, refer to Section 5.1.9 (Verify Recorder Outputs) for steps to verify recorder output.
5. If the reading does not meet specifications, check that the input signal is correct. If the monitor still does not meet specifications or fails any other part of this test, go to Section 5.1.10 (If a Channel Fails a Verification Test).
6. Disconnect the test equipment and reconnect the PWR, COM, and SIG field wiring to the channel terminals on the I/O module. Verify that the OK LED comes on and the OK relay energizes. Press the RESET switch on the Rack Interface Module (RIM) to reset the OK LED.
7. Repeat steps 1 through 6 for all configured channels.

1X Phase

Note

If the test equipment is not capable of changing the phase output to a known value, use the following procedure. If your test equipment can change the phase output to a known value, use the procedure on page 134.

1. Disconnect PWR, COM, and SIG field wiring from the channel terminals on the I/O module.
2. Connect test equipment and run software as described in Section 5.1.5.1 (Test Equipment and Software Setup - Radial Vibration). Set the Keyphasor multiplier/divider so that the multiply setting is one and the divide setting is one.

3. Attach one channel of a two channel oscilloscope to the vibration signal buffered output and attach the other channel to the associated Keyphasor® signal buffered output and observe the two signals simultaneously.
4. Measure the phase. 1X Phase will be measured from the leading edge of the Keyphasor® pulse to the first positive peak of the vibration signal. See the example below (on page 133) which illustrates a phase of 45°. Observe the 1X Phase bar graph display and Current Value Box; it should read approximately what was measured above.

Example:

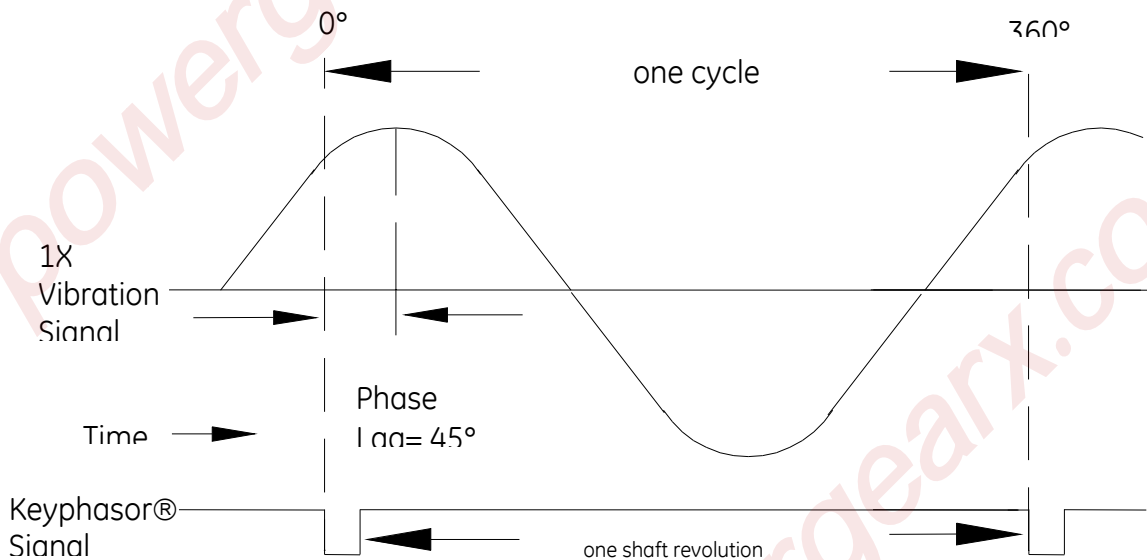

1X = one cycle of vibration signal per shaft revolution.

5. Disconnect the test equipment and reconnect the PWR, COM, and SIG field wiring to the channel terminals on the I/O module. Verify that the OK LED comes on and the OK relay energizes. Press the RESET switch on the Rack Interface Module (RIM) to reset the OK LED.
6. Repeat steps 1 through 5 for all configured channels.

Note

If the test equipment has the capability to change the phase output to a known value, use the following procedures.

1. Disconnect PWR, COM, and SIG field wiring from the channel terminals on the I/O module.
2. Connect test equipment and run software as described in Section 5.1.5.1 (Test Equipment and Software Setup - Radial Vibration). Set the Keyphasor multiplier/divider so that the multiply setting is one and the divide setting is one.
3. Adjust the phase for mid-scale. Verify that the 1X Phase bar graph display and Current Value Box is reading $\pm 1.5\%$ of mid-scale. If the recorder output is configured, refer to Section 5.1.9 (Verify Recorder Outputs) for steps to verify recorder output.
4. If the reading does not meet specifications double check the input signal to ensure it is correct. If the monitor still does not meet specifications or fails any other part of this test, go to Section 5.1.10 (If a Channel Fails a Verification Test).
5. Disconnect the test equipment and reconnect the PWR, COM, and SIG field wiring to the channel terminals on the I/O module. Verify that the OK LED comes on and the OK relay energizes. Press the RESET switch on the Rack Interface Module (RIM) to reset the OK LED.
6. Repeat steps 1 through 5 for all configured channels.

2X Amplitude (2X Ampl)

<p style="text-align: center;">Note</p>
--

<p>The Keyphasor must be triggering and have a valid rpm value to check this parameter.</p>

1. Disconnect PWR, COM, and SIG field wiring from the channel terminals on the I/O module.
2. Connect test equipment and run software as described in Section 5.1.5.1 (Test Equipment and Software Setup - Radial Vibration).
3. Calculate the full-scale voltage according to the equation and examples shown below. Adjust the function generator amplitude to the calculated voltage.

$$\text{Full Scale Voltage} = 2X \text{ Ampl Meter Top Scale} \times \text{Transducer Scale Factor}$$

Note

Use the Transducer Scale Factor displayed in the Scale Factor Box on the Verification Screen.

Example 1:

2X Ampl Meter Top Scale = 10 mil
 Transducer Scale Factor = 200 mV/mil

$$\begin{aligned}\text{Full Scale} &= (10 \times 0.200) \\ &= 2.000 \text{ Vpp}\end{aligned}$$

For V_{rms} input:

$$\begin{aligned}V_{\text{rms}} &= (0.707/2) \times (V_{\text{pp}}), \text{ for a sine wave input} \\ &= (0.707/2) \times (2) \\ &= 0.707 \text{ Vrms}\end{aligned}$$

Example 2:

2X Ampl Meter Top Scale = 200 μm
 Transducer Scale Factor = 7,874 mV/mm
 = 7.874 mV/ μm

$$\begin{aligned}\text{Full Scale} &= (200 \times 0.007874) \\ &= 1.5748 \text{ Vpp}\end{aligned}$$

For V_{rms} input:

$$\begin{aligned}V_{\text{rms}} &= (0.707/2) \times (V_{\text{pp}}), \text{ for a sine wave input} \\ &= (0.707/2) \times (1.574) \\ &= 0.5566 \text{ Vrms}\end{aligned}$$

4. Set the Keyphasor multiplier/divider so that the multiply setting is one and the divide setting is two. Verify that the 2X Ampl bar graph display and Current Value Box is reading $\pm 1\%$ of full scale. If the recorder output is configured, refer to Section 5.1.9 (Verify Recorder Outputs) for steps to verify recorder output.
5. If the reading does not meet specifications, check that the input signal is correct. If the monitor still does not meet specifications or fails any other part of this test, go to Section 5.1.10 (If a Channel Fails a Verification Test).
6. Disconnect the test equipment and reconnect the PWR, COM, and SIG field wiring to the channel terminals on the I/O module. Verify that the OK LED

comes on and the OK relay energizes. Press the RESET switch on the Rack Interface Module (RIM) to reset the OK LED.

7. Repeat steps 1 through 6 for all configured channels.

2X Phase

Note

If the test equipment is not capable of changing the phase output to a known value, use the following procedure. If your test equipment can change the phase output to a known value, use the procedure on page 137.

1. Disconnect PWR, COM, and SIG field wiring from the channel terminals on the I/O module.
 2. Connect test equipment and run software as described in Section 5.1.5.1 (Test Equipment and Software Setup - Radial Vibration). Set the Keyphasor multiplier/divider so that the multiply setting is one and the divide setting is two.
 3. Attach one channel of the two channel oscilloscope to the vibration signal buffered output and attach the other channel to the associated Keyphasor[®] signal buffered output and observe the two signals simultaneously.
 4. Measure the phase. 2X Phase will be measured from the leading edge of the Keyphasor[®] pulse to the first positive peak of the vibration signal. See the example below (on page 136) which illustrates a phase of 90°.
- Observe the 2X Phase bar graph display and Current Value Box; it should read approximately what was measured above.

Example:

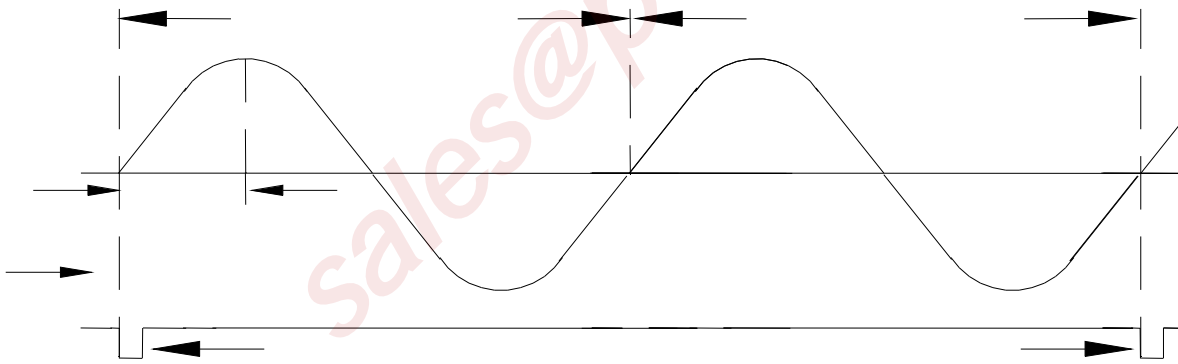

	0°	360°
	first cycle	second cycle
2X Vibration Signal	2X = two cycles of vibration signal per shaft revolution	
Time Keyphasor Signal	<p>5. Disconnect the test equipment and reconnect the PWR, COM, and SIG field wiring to the channel terminals on the I/O module. Verify that the OK LED comes on and the OK relay energizes. Press the RESET switch on the Rack Interface Module (RIM) to reset the OK LED.</p> <p>6. Repeat steps 1 through 5 for all configured channels.</p>	

Note

If the test equipment has the capability to change the phase output to a known value, use the following procedure.

1. Disconnect PWR, COM, and SIG field wiring from the channel terminals on the I/O module.
2. Connect test equipment and run software as described in Section 5.1.5.1 (Test Equipment and Software Setup - Radial Vibration). Set the Keyphasor multiplier/divider so that the multiply setting is one and the divide setting is two.
3. Adjust the phase for mid-scale. Verify that the 2X Phase bar graph display and Current Value Box is reading $\pm 1.5\%$ of mid-scale. If the recorder output is configured, refer to Section 5.1.9 (Verify Recorder Outputs) for steps to verify the recorder output.
4. If the reading does not meet specifications, double check the input signal to ensure it is correct. If the monitor still does not meet specifications and/or fails any other part of this test, go to Section 5.1.10 (If a Channel Fails a Verification Test).
5. Disconnect the test equipment and reconnect the PWR, COM, and SIG field wiring to the channel terminals on the I/O module. Verify that the OK LED comes on and the OK relay energizes. Press the RESET switch on the Rack Interface Module (RIM) to reset the OK LED.
6. Repeat steps 1 through 5 for all configured channels.

Not 1X Amplitude

Note

The Keyphasor must be triggering and have a valid rpm value to check this parameter.

1. Disconnect PWR, COM, and SIG field wiring from the channel terminals on the I/O module.
2. Connect test equipment and run software as described in Section 5.1.5.1 (Test Equipment and Software Setup - Radial Vibration).
3. Calculate the full-scale voltage according to the equation and example shown below. Adjust the function generator amplitude to the calculated voltage.

Full-Scale Voltage =

$$\text{Not 1X Ampl Meter Top Scale} \times \text{Transducer Scale Factor}$$

Note

Use the Transducer Scale Factor displayed in the Scale Factor Box on the Verification Screen.

Example 1:

Not 1X Ampl Meter Top Scale = 10 mil

Transducer Scale Factor = 200 mV/mil

$$\begin{aligned} \text{Full Scale} &= (10 \times 0.200) \\ &= 2.000 \text{ Vpp} \end{aligned}$$

For Vrms input:

$$\begin{aligned} \text{Vrms} &= (0.707/2) \times (\text{Vpp}), \text{ for a sinewave input} \\ &= (0.707/2) \times (2) \\ &= 0.707 \text{ Vrms} \end{aligned}$$

Example 2:

Not 1X Ampl Meter Top Scale = 200 μm

Transducer Scale Factor = 7,874 mV/mm
= 7.874 mV/ μm

$$\begin{aligned}\text{Full Scale} &= (200 \times 0.007874) \\ &= 1.5748 \text{ Vpp}\end{aligned}$$

For V_{rms} input:

$$\begin{aligned}V_{\text{rms}} &= (0.707/2) \times (V_{\text{pp}}), \text{ for a sinewave input} \\ &= (0.707/2) \times (1.574) \\ &= 0.5566 \text{ Vrms}\end{aligned}$$

4. Set the Keyphasor multiplier/divider so that the multiply setting is one and the divide setting is two. Verify that the Not 1X bar graph display and Current Value Box is reading $\pm 1\%$ of full scale. If the recorder output is configured, refer to Section 5.1.9 (Verify Recorder Outputs) for steps to verify the recorder output.
5. If the reading does not meet specifications, check that the input signal is correct. If the monitor still does not meet specifications or fails any other part of this test, go to Section 5.1.10 (If a Channel Fails a Verification Test).
6. Disconnect the test equipment and reconnect the PWR, COM, and SIG field wiring to the channel terminals on the I/O module. Verify that the OK LED comes on and the OK relay energizes. Press the RESET switch on the Rack Interface Module (RIM) to reset the OK LED.
7. Repeat steps 1 through 6 for all configured channels.

S_{max} Amplitude

Note

The Keyphasor must be triggering and have a valid rpm value to check this parameter.

1. Disconnect PWR, COM, and SIG field wiring from the channel pair terminals on the I/O module.
2. Connect test equipment and run software as described in Section 5.1.5.1 (Test Equipment and Software Setup - Radial Vibration). **S_{max} requires input connections to both channel 1 and 2 or channel 3 and 4.**
3. Calculate the full-scale voltage using the equation and example shown below.

Full-Scale Voltage =

$$(S_{\max} \text{ Meter Top Scale} \times \text{Transducer Scale Factor}) \times 1.414$$

Note

Use the Transducer Scale Factor displayed in the Scale Factor Box on the Verification Screen.

Example 1:

S_{\max} Meter Top Scale = 10 mil

Transducer Scale Factor = 200 mV/mil

$$\begin{aligned} \text{Full Scale} &= (10 \times 0.200) \times 1.414 \\ &= 2.828 \text{ Vpp} \end{aligned}$$

For V_{rms} input:

$$\begin{aligned} V_{\text{rms}} &= (0.707/2) \times (V_{\text{pp}}), \text{ for a sinewave input} \\ &= (0.707/2) \times (2.828) \\ &= 0.999 \text{ Vrms} \end{aligned}$$

Example 2:

S_{\max} Meter Top Scale = 200 μm

Transducer Scale Factor = 7,874 mV/mm
= 7.874 mV/ μm

$$\begin{aligned} \text{Full Scale} &= (200 \times .007874) \times 1.414 \\ &= 2.2267 \text{ Vpp} \end{aligned}$$

For V_{rms} input:

$$\begin{aligned} V_{\text{rms}} &= (0.707/2) \times (V_{\text{pp}}), \text{ for a sinewave input} \\ &= (0.707/2) \times (2.2267) \\ &= 0.7871 \text{ Vrms} \end{aligned}$$

4. Set the Keyphasor multiplier/divider so that the multiply setting is set to one and the divide setting is set to one. Adjust the function generator amplitude for full scale. Verify that the S_{\max} bar graph display and Current Value Box is reading $\pm 1\%$ of full scale. If the recorder output is configured, refer to Section 5.1.9 (Verify Recorder Outputs) for steps to verify the recorder output.
5. If the reading does not meet specifications, check that the input signal is correct. If the monitor still does not meet specifications or fails any other

part of this test, go to Section 5.1.10 (If a Channel Fails a Verification Test).

6. Disconnect the test equipment and reconnect the PWR, COM, and SIG field wiring to the channel pair terminals on the I/O module. Verify that the OK LED comes on and the OK relay energizes. Press the RESET switch on the Rack Interface Module (RIM) to reset the OK LED.
7. Repeat steps 1 through 6 for all configured channels.

5.1.5.4 Test OK Limits

The general approach for testing OK limits is to input a DC voltage and adjust it above the Upper OK limit and below the Lower OK limit. This will cause a channel not OK condition and the OK Relay to change state (de-energize). The Upper and Lower OK limits are displayed in the Verification screen on the test computer.

1. Disconnect PWR, COM, and SIG field wiring from the channel terminals on the I/O module.
2. Connect test equipment and run software as described in Section 5.1.5.1 (Test Equipment and Software Setup - Radial Vibration).
3. Bypass all other configured channels.
4. Adjust the power supply voltage to -7.00 Vdc.
5. Press the RESET switch on the Rack Interface Module (RIM). Verify that the monitor OK LED is on and that the Channel OK State line in the Channel Status box of the Verification screen reads **OK**.

Note

If the Danger Bypass has been activated, then the BYPASS LED will be on. All other channels in the rack must be OK or bypassed for the relay to be energized.

6. Verify that the OK relay on the Rack Interface I/O Module indicates OK (energized). See 3500/20 Rack Interface Module Operation and Maintenance Manual, part number 129768-01.
7. Increase the power supply voltage (more negative) until the OK LED just goes off (upper limit). Verify that the Channel OK State line in the Channel

Status box reads **not OK** and that the OK Relay indicates not OK. Verify that the Upper OK limit voltage displayed on the Verification screen is equal to or more positive than the input voltage.

8. Decrease the power supply voltage (less negative) to -7.00 Vdc.
9. Press the RESET switch on the Rack Interface Module (RIM). Verify that the OK LED comes back on and the OK relay energizes. Verify that the Channel OK State line in the Channel Status box reads **OK**.
10. Gradually decrease the power supply voltage (less negative) until the OK LED just goes off (lower limit). Verify that the Channel OK State line in the Channel Status box reads **not OK** and that the OK Relay indicates not OK. Verify that the Lower OK limit voltage displayed on the Verification screen is equal to or more negative than the input voltage.
11. Increase the power supply voltage (more negative) to -7.00 Vdc.
12. Press the RESET switch on the Rack Interface Module (RIM). Verify that the OK LED comes back on, the OK relay energizes and that the Channel OK State line in the Channel Status box reads **OK**.
13. If you can not verify any configured OK limit, go to Section 5.1.10 (If a Channel Fails a Verification Test).
14. Disconnect the test equipment and reconnect the PWR, COM, and SIG field wiring to the channel terminals on the Monitor I/O Module. Press the RESET switch on the Rack Interface Module (RIM) and verify that the OK LED comes on and the OK relay energizes.
15. Repeat steps 1 through 14 for all configured channels.
16. Return the bypass switch for all configured channels back to their original setting.

Radial Vibration Default OK Limits Table

Transducer	Lower OK Limit (volts)	Upper OK Limit (volts)
7200 5&8 mm w/ barriers	-2.7 to -2.8	-16.7 to -16.8
7200 5&8 mm w/o barriers	-2.7 to -2.8	-16.7 to -16.8
7200 11 mm w/o barriers	-3.5 to -3.6	-19.6 to -19.7
7200 14 mm w/o barriers	-2.7 to -2.8	-16.7 to -16.8
3300 5&8 mm w/ barriers	-2.7 to -2.8	-16.7 to -16.8
3300 5&8 mm w/o barriers	-2.7 to -2.8	-16.7 to -16.8
3000 (-18 V) w/o barriers	-2.4 to -2.5	-12.0 to -12.1
3000 (-24 V) w/o barriers	-3.2 to -3.3	-15.7 to -15.8
3300 RAM w/o barriers	-2.4 to -2.5	-12.5 to -12.6
3300 RAM w/ barriers	-2.4 to -2.5	-12.1 to -12.2
3300 16 mm HTPS w/o barriers	-2.7 to -2.8	-16.7 to -16.8

Note: Assume ± 50 mV accuracy for check tolerance.

Thrust Position and Differential Expansion Channels

The following sections describe how to test alarms, verify channels, and test OK limits for channels configured as Thrust Position and Differential Expansion. The output values and alarm setpoints are verified by varying the input DC voltage from a power supply and observing that the correct results are reported in the Verification screen on the test computer.

Thrust Position and Differential Expansion channels can be configured for the following channel values and alarms:

Channel Values	Alarms	
	Over	Under
Direct	X	X
Gap	X	X

5.1.5.5 Test Equipment and Software Setup - Thrust Position and Differential Expansion

The following test equipment and software setup can be used as the initial setup needed for all the Thrust Position and Differential Expansion channel verification procedures (Test Alarms, Verify Channels, and Test OK Limits).

 WARNING
<p>High voltage present. Contact could cause shock, burns, or death.</p> <p>Do not touch exposed wires or terminals.</p>

Application Alert
<p>Tests will exceed alarm setpoint levels causing alarms to activate. This could result in a relay contact state change.</p>

Application Alert
<p>Disconnecting field wiring will cause a not OK condition.</p>

Test Equipment Setup - Thrust Position and Differential Expansion

Simulate the transducer signal by connecting power supply (output terminals) and multimeter (input terminals) to COM and SIG of channel 1 with polarity as shown in the figure on page 145 (Thrust Position and Differential Expansion Test Setup).

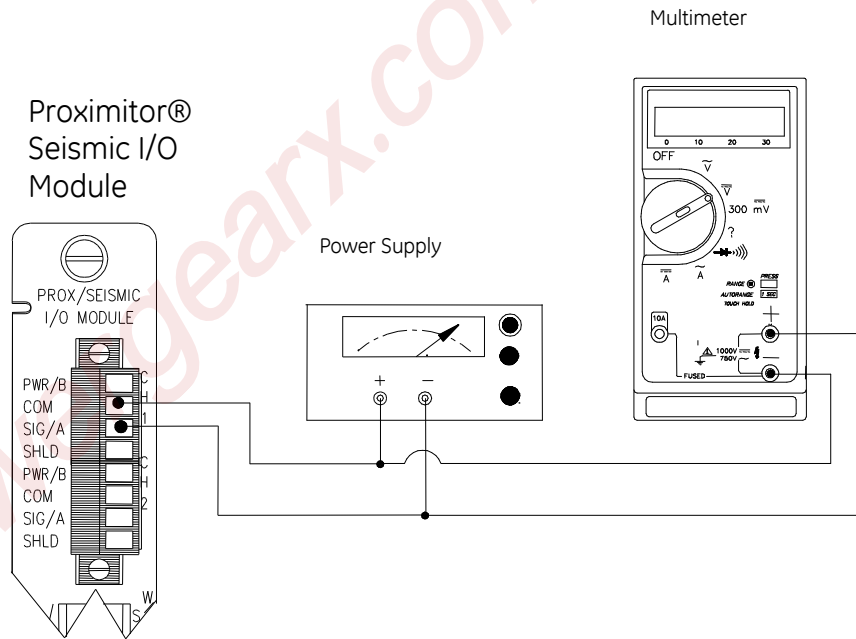

Thrust Position and Differential Expansion Test Setup

The Test Equipment outputs should be floating relative to earth ground.

Verification Screen Setup - Thrust Position and Differential Expansion

Run the Rack Configuration Software on the test computer. Choose **Verification** from the Utilities menu and choose the proper Slot number and Channel number then click on the **Verify** button.

The following table directs you to the starting page of each maintenance section associated with the Thrust Position and Differential Expansion Channels.

Section Number	Topic	Page Number
5.1.5.6	Test Alarms - Direct	146
5.1.5.6	Test Alarms - Gap	148
5.1.5.7	Verify Channel Values - Direct	149
5.1.5.7	Verify Channel Values - Gap	152
5.1.5.8	Test OK Limits	153

5.1.5.6 Test Alarms - Thrust Position and Differential Expansion

The general approach for testing alarm setpoints is to simulate the Thrust Position and Differential Expansion signal with a power supply. The alarm levels are tested by varying the DC voltage and observing that the correct results are reported in the Verification screen on the test computer. It is only necessary to test those alarm parameters that are configured and being used. The general test procedure to verify current alarm operation will include simulating a transducer input signal and varying this signal:

1. to exceed over Alert/Alarm 1 and Danger/Alarm 2 Setpoints.
2. to drop below any under Alert/Alarm 1 and Danger/Alarm 2 Setpoints.
3. to produce a nonalarm condition.

Direct

1. Disconnect PWR, COM, and SIG field wiring from the channel terminals on the I/O module.
2. Connect test equipment and run software as described in Section 5.1.5.5

(Test Equipment and Software Setup - Thrust Position and Differential Expansion).

3. Adjust the power supply to produce a voltage that is within the Direct setpoint levels on the Direct bar graph display of the Verification screen.
4. Press the RESET switch on the Rack Interface Module (RIM). Verify that the OK LED is on, the bar graph indicator for Direct is green, and the Current Value field has no alarm indication.
5. Adjust the power supply voltage such that the signal just exceeds the Direct Over Alert/Alarm 1 setpoint level. Wait for 2 or 3 seconds after the alarm time delay expires and verify that the bar graph indicator for Direct changes color from green to yellow and that the Current Value Field indicates an Alarm.
6. Press the RESET switch on the Rack Interface Module (RIM). Verify that the bar graph indicator for Direct remains yellow and that the Current Value Field still indicates an Alarm.
7. Adjust the power supply such that the signal just exceeds the Direct Over Danger/Alarm 2 setpoint level. Wait for 2 or 3 seconds after the alarm time delay expires and verify that the bar graph indicator for Direct changes color from yellow to red and that the Current Value Field indicates an Alarm.
8. Press the RESET switch on the Rack Interface Module (RIM). Verify that the bar graph indicator for Direct remains red and that the Current Value Field still indicates an Alarm.
9. Adjust the power supply voltage such that the signal reads below the Over Alarm setpoint levels. If the nonlatching option is configured, observe that the bar graph indicator for Direct changes color to green and that the Current Value Box contains no indication of alarms. Press the RESET switch on the Rack Interface Module (RIM) to reset latching alarms.
10. Repeat steps 3 through 9 to test the Under Alert/Alarm 1 and Under Danger/Alarm 2 setpoints by adjusting the power supply to exceed the Under Alarm setpoint levels.
11. If you can not verify any configured alarm, recheck the configured setpoints. If the monitor still does not alarm properly or fails any other part of this test, go to Section 5.1.10 (If a Channel Fails a Verification Test).

12. Disconnect the test equipment and reconnect the PWR, COM, and SIG field wiring to the channel terminals on the I/O module. Verify that the OK LED comes on and the OK relay energizes. Press the RESET switch on the Rack Interface Module (RIM) to reset the OK LED.
13. Repeat steps 1 through 12 for all configured channels.

Gap

1. Disconnect PWR, COM, and SIG field wiring from the channel terminals on the I/O module.
2. Connect test equipment and run software as described in Section 5.1.5.5 (Test Equipment and Software Setup - Thrust Position and Differential Expansion).
3. Adjust the power supply to produce a voltage that is within the Gap setpoint levels on the Gap bar graph display.
4. Press the RESET switch on the Rack Interface Module (RIM). Verify that the OK LED is on, the bar graph indicator for Gap is green, and the Current Value field has no alarm indication.
5. Adjust the power supply voltage such that the signal just exceeds the Gap Over Alert/Alarm 1 setpoint level. Wait for 2 or 3 seconds until the alarm time delay expires and verify that the bar graph indicator for Gap changes color from green to yellow and that the Current Value Field indicates an Alarm.
6. Press the RESET switch on the Rack Interface Module (RIM). Verify that the bar graph indicator for Gap remains yellow and that the Current Field still indicates an Alarm.
7. Adjust the power supply such that the signal just exceeds the Gap Over Danger/Alarm 2 setpoint level. Wait for 2 or 3 seconds after the alarm time delay expires and verify that the bar graph indicator for Gap changes color from yellow to red and that the Current Value Field indicates an Alarm.
8. Press the RESET switch on the Rack Interface Module (RIM). Verify that the bar graph indicator for Gap remains red and that the Current Value Field still indicates an Alarm.

9. Adjust the power supply voltage such that the signal reads below the Over Alarm setpoint levels. If the nonlatching option is configured, observe that the bar graph indicator for Gap changes color to green and that the Current Value Box contains no indication of alarms. Press the RESET switch on the Rack Interface Module (RIM) to reset latching alarms.
10. Repeat steps 5 through 9 to test the Under Alert/Alarm 1 and Under Danger/Alarm 2 setpoints by adjusting the power supply to exceed the Under Alarm setpoint levels.
11. If you can not verify any configured alarm, recheck the configured setpoints. If the monitor still does not alarm properly or fails any other part of this test, go to Section 5.1.10 (If a Channel Fails a Verification Test).
12. Disconnect the test equipment and reconnect the PWR, COM, and SIG field wiring to the channel terminals on the I/O module. Verify that the OK LED comes on and the OK relay energizes. Press the RESET switch on the Rack Interface Module (RIM) to reset the OK LED.
13. Repeat steps 1 through 12 for all configured channels.

5.1.5.7 Verify Channel Values - Thrust Position and Differential Expansion

The general approach for testing these parameters is to simulate the Thrust Position and Differential Expansion signal with a power supply. The output values are verified by varying the input DC voltage and observing that the correct results are reported in the Verification screen on the test computer.

Direct

1. Disconnect PWR, COM, and SIG field wiring from the channel terminals on the I/O module.
2. Connect test equipment and run software as described in Section 5.1.5.5 (Test Equipment and Software Setup - Thrust Position and Differential Expansion).
3. Calculate the full-scale and bottom scale values. These values can be calculated in the following way:

Full-scale Value, Bottom Scale Value =

Zero Position Voltage \pm (Transducer Scale Factor \times Scale Range)

Note

The Zero Position Voltage is the voltage input that will cause the reading on the bar graph display and the Current Value Box to be zero. The Zero Position Volts value is displayed in the Z.P. Volts box above each channel value bar graph.

Note

If the bottom scale range is zero (for example 0 to 80 mil), use the Full-scale Value formula.

Note

Use the Transducer Scale Factor displayed in the Scale Factor Box on the Verification Screen.

If Upscale direction (Normal for Thrust, Long for Differential Expansion) is toward the probe:

Full Scale =

$$(\text{Zero Position Voltage}) + (\text{Transducer Scale Factor} \times \text{Top Meter Scale})$$

Bottom Scale =

$$(\text{Zero Position Voltage}) - (\text{Transducer Scale Factor} \times \text{ABS (Bottom Meter Scale)})$$

Example 1:

Transducer scale factor = 200 mV/mil

Meter scale range = 25-0-25 mil

Zero Position Voltage = -9.75 Vdc

$$\begin{aligned} \text{Full Scale Value} &= (-9.75) + (0.200 \times 25) \\ &= -4.75 \text{ Vdc} \end{aligned}$$

$$\begin{aligned} \text{Bottom Scale Value} &= (-9.75) - (0.200 \times 25) \\ &= -14.75 \text{ Vdc} \end{aligned}$$

Example 2:

Transducer scale factor = 7,874 mV/mm

Meter scale range = 1-0-1 mm

Zero Position Voltage = -10.16 Vdc

$$\begin{aligned}\text{Full Scale Value} &= (-10.16) + (7.874 \times 1) \\ &= -2.286 \text{ Vdc}\end{aligned}$$

$$\begin{aligned}\text{Bottom Scale Value} &= (-10.16) - (7.874 \times 1) \\ &= -18.03 \text{ Vdc}\end{aligned}$$

If Upscale direction (Normal for Thrust, Long for Differential Expansion) is away from the probe:

Full Scale =

$$(\text{Zero Position Voltage}) - (\text{Transducer Scale Factor} \times \text{Top Meter Scale})$$

Bottom Scale =

$$(\text{Zero Position Voltage}) + (\text{Transducer Scale Factor} \times \text{ABS}(\text{Bottom Meter Scale}))$$

Example 1:

Transducer scale factor = 200 mV/mil

Meter scale range = 25-0-25 mil

Zero Position Voltage = -9.75 Vdc

$$\begin{aligned}\text{Full Scale Value} &= (-9.75) - (0.200 \times 25) \\ &= -14.75 \text{ Vdc}\end{aligned}$$

$$\begin{aligned}\text{Bottom Scale Value} &= (-9.75) + (0.200 \times 25) \\ &= -4.75 \text{ Vdc}\end{aligned}$$

Example 2:

Transducer scale factor = 7,874 mV/mm

Meter scale range = 1-0-1 mm

Zero Position Voltage = -10.16 Vdc

$$\text{Full Scale Value} = (-10.16) - (7.874 \times 1)$$

$$= -18.03 \text{ Vdc}$$

$$\begin{aligned} \text{Bottom Scale Value} &= (-10.16) + (7.874 \times 1) \\ &= -2.286 \text{ Vdc} \end{aligned}$$

4. Adjust the power supply voltage to match the voltage displayed in the Z.P. Volts box. The Direct bar graph display and the Current Value Box should read 0 mil (0 mm) ± 1 %.
5. Adjust the power supply voltage for the calculated full scale. Verify that the Direct bar graph display and the Current Value Box is reading ± 1 % of full scale. If the recorder output is configured, refer to Section 5.1.9 (Verify Recorder Outputs) for steps to verify the recorder output.
6. Adjust the power supply voltage for the calculated bottom scale. Verify that the Direct bar graph display and the Current Value Box is reading ± 1 % of bottom scale. If the recorder output is configured, refer to Section 5.1.9 (Verify Recorder Outputs) for steps to verify the recorder output.
7. If the reading does not meet specifications, check that the input signal is correct. If the monitor still does not meet specifications or fails any other part of this test, go to Section 5.1.10 (If a Channel Fails a Verification Test).
8. Disconnect the test equipment and reconnect the PWR, COM, and SIG field wiring to the channel terminals on the I/O module. Verify that the OK LED comes on and the OK relay energizes. Press the RESET switch on the Rack Interface Module (RIM) to reset the OK LED.
9. Repeat steps 1 through 8 for all configured channels.

Gap

1. Disconnect PWR, COM, and SIG field wiring from the channel terminals on the I/O module.
2. Connect test equipment and run software as described in Section 5.1.5.5 (Test Equipment and Software Setup - Thrust Position and Differential Expansion).
3. Adjust the power supply to produce a voltage equal to -18.00 Vdc on the Gap bar graph display. Verify that the Gap bar graph display and the Current Value Box is reading ± 1 % of -18.00 Vdc. If the recorder output is

configured, refer to Section 5.1.9 (Verify Recorder Outputs) for steps to verify the recorder output.

4. Adjust the power supply to produce a voltage equal to mid-scale on the Gap bar graph display. Verify that the Gap bar graph and Current Value Box is reading $\pm 1\%$ of the mid-scale value. If the recorder output is configured, refer to Section 5.1.9 (Verify Recorder Outputs) for steps to verify the recorder output.
5. If the reading does not meet specifications, check that the input signal is correct. If the monitor still does not meet specifications or fails any other part of this test, go to Section 5.1.10 (If a Channel Fails a Verification Test).
6. Disconnect the test equipment and reconnect the PWR, COM, and SIG field wiring to the channel terminals on the I/O module. Verify that the OK LED comes on and the OK relay energizes. Press the RESET switch on the Rack Interface Module (RIM) to reset the OK LED.
7. Repeat steps 1 through 6 for all configured channels.

5.1.5.8 Test OK Limits - Thrust Position and Differential Expansion

The general approach for testing OK limits is to input a DC voltage and adjust it above the Upper OK limit and below the Lower OK limit. This will cause a channel not OK condition and the OK Relay to change state (de-energize). The Upper and Lower OK limits are displayed in the Verification screen on the test computer.

1. Disconnect PWR, COM, and SIG field wiring from the channel terminals on the I/O module.
2. Connect test equipment and run software as described in Section 5.1.5.5 (Test Equipment and Software Setup - Thrust Position and Differential Expansion).
3. Bypass all other configured channels.
4. Adjust the power supply voltage to -7.00 Vdc.
5. Press the RESET switch on the Rack Interface Module (RIM). Verify that the monitor OK LED is on and that the Channel OK State line in the Channel Status box of the Verification screen reads **OK**.

Note

If the Danger Bypass has been activated, then the BYPASS LED will be on. All other channels in the rack must be OK or bypassed for the OK relay to be energized.

6. Verify that the OK relay on the Rack Interface I/O Module indicates OK (energized). See 3500/20 Rack Interface Module Operation and Maintenance Manual, part number 129768-01.
7. Increase the power supply voltage (more negative) until the OK LED just goes off (upper limit). Verify that the Channel OK State line in the Channel Status box reads **not OK** and that the OK Relay indicates not OK. Verify that the Upper OK limit voltage displayed on the Verification screen is equal to or more positive than the input voltage.
8. Decrease the power supply voltage (less negative) to -7.00 Vdc.
9. Press the RESET switch on the Rack Interface Module (RIM). Verify that the OK LED comes back on, the OK relay energizes, and the Channel OK State line in the Channel Status box reads **OK**.
10. Gradually decrease the power supply voltage (less negative) until the OK LED just goes off (lower limit). Verify that the Channel OK State line in the Channel Status box reads **not OK** and that the OK Relay indicates not OK. Verify that the Lower OK limit voltage displayed on the Verification screen is equal to or more negative than the input voltage.
11. Increase the power supply voltage (more negative) to -7.00 Vdc.
12. Press the RESET switch on the Rack Interface Module (RIM). Verify that the OK LED comes back on, the OK relay energizes, and the Channel OK State line in the Channel Status box reads **OK**.
13. If you can not verify any configured OK limit, go to Section 5.1.10 (If a Channel Fails a Verification Test).
14. Disconnect the test equipment and reconnect the PWR, COM, and SIG field wiring to the channel terminals on the Monitor I/O Module. Press the RESET switch on the Rack Interface Module (RIM) and verify that the OK LED comes on and the OK relay energizes.
15. Repeat steps 1 through 14 for all configured channels.
16. Return the bypass switch for all configured channels to their original

setting.

Thrust Position Default OK Limits Table

Transducer	Lower OK Limit (volts)	Upper OK Limit (volts)
7200 5 & 8 mm w/ barriers	-1.05 to -1.15 -1.23 to -1.33 *	-18.15 to -18.25
7200 5 & 8 mm w/o barriers	-1.23 to -1.33	-18.99 to -19.09
7200 11 mm w/o barriers	-3.50 to -3.60	-20.34 to -20.44
7200 14 mm w/o barriers	-1.6 to -1.7	-18.0 to -18.1
3300 5&8 mm w/ barriers	-1.05 to -1.15 -1.23 to -1.33 *	-18.15 to -18.25
3300 5&8 mm w/o barriers	-1.23 to -1.33	-18.99 to -19.09
3000 (-18V) w/o barriers	-1.11 to -1.21	-13.09 to -13.19
3000 (-24V) w/o barriers	-2.2 to -2.3	-16.8 to -16.9
3300 RAM w/o barriers	-1.11 to -1.21	-13.09 to -13.19
3300 RAM w/ barriers	-1.0 to -1.1 -1.11 to -1.21 *	-12.3 to -12.4
3300 16mm HTPS w/o barriers	-1.6 to -1.7	-18.0 to -18.1

Note: Assume ± 50 mV accuracy for check tolerance.

* = BNC Internal Barrier I/O Modules.

Differential Expansion Default OK Limits Table

Transducer	Lower OK Limit (volts)	Upper OK Limit (volts)
25 mm w/o barriers	-1.30 to -1.40	-12.5 to -12.6
35 mm w/o barriers	-1.30 to -1.40	-12.5 to -12.6
50 mm w/o barriers	-1.30 to -1.40	-12.5 to -12.6

Note: Assume ± 50 mV accuracy for check tolerance.

5.1.6 Eccentricity Channels

The following sections describe how to test alarms, verify channels, and test OK limits for channels configured as Eccentricity. The output values and alarm setpoints are verified by varying the input Eccentricity signal level (both peak to peak amplitude and DC voltage bias) and observing that the correct results are reported in the Verification screen on the test computer.

Eccentricity channels can be configured for the following channel values and alarms:

Channel Values	Alarms	
	Over	Under
Peak to Peak	X	
Gap	X	X
Direct	X	X

5.1.6.1 Test Equipment and Software Setup - Eccentricity

The following test equipment and software setup can be used as the initial setup needed for all the Eccentricity channel verification procedures (Test Alarms, Verify Channels, and Test OK Limits).

 WARNING
<p>High voltage present. Contact could cause shock, burns, or death. Do not touch exposed wires or terminals.</p>

Application Alert
<p>Tests will exceed alarm setpoint levels causing alarms to activate. This could result in a relay contact state change.</p>

Application Alert
<p>Disconnecting field wiring will cause a not OK condition.</p>

Test Equipment Setup - Eccentricity

Simulate the transducer signal by connecting the power supply, function generator and multimeter to COM and SIG of channel 1 with polarity as shown in the figure on page 158 Eccentricity Test Setup). Set the test equipment as specified below:

Power Supply	Function Generator
-7.00 Vdc	Waveform: sinewave DC Volts: 0 Vdc Frequency: 5 Hz Amplitude level: Minimum (Above Zero)

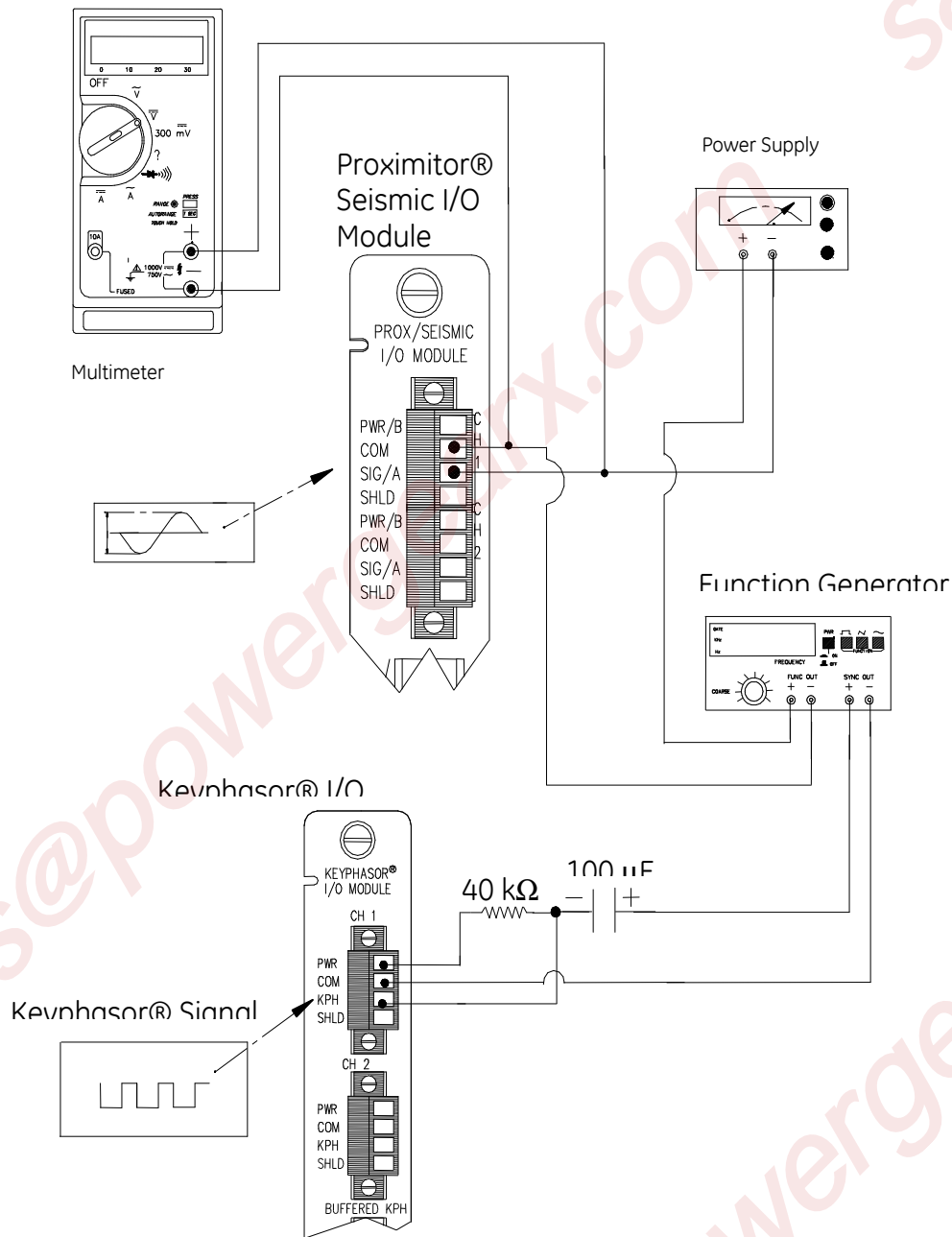

Eccentricity Test Setup

The Test Equipment outputs should be floating relative to earth ground.

Verification Screen Setup - Eccentricity

Run the Rack Configuration Software on the test computer. Choose **Verification** from the Utilities menu and choose the proper Slot number and Channel number then click on the **Verify** button.

Note

If the Timed OK Channel Defeat is enabled, the OK LED will not come on immediately after you connect the test equipment. It will take 60 seconds for a channel to return to the **OK** status from **not OK**. If OK mode is configured for latching, press the RESET button on the Rack Interface Module (RIM) to return to the **OK** status.

The following table directs you to the starting page of each maintenance section associated with the Eccentricity Channels.

Section Number	Topic	Page Number
5.1.6.2	Test Alarms - Peak to Peak	160
5.1.6.2	Test Alarms - Gap	161
5.1.6.2	Test Alarms - Direct	162
5.1.6.3	Verify Channel Values - Peak to Peak	164
5.1.6.3	Verify Channel Values - Gap	165
5.1.6.3	Verify Channel Values - Direct	166
5.1.6.4	Test OK Limits	168

5.1.6.2 Test Alarms - Eccentricity

The general approach for testing alarm setpoints is to simulate the eccentricity signal with a function generator and power supply. The alarm levels are tested by varying the output from the test equipment and observing that the correct results are reported in the Verification screen on the test computer. It is only necessary to test those alarm parameters that are configured and being used. The general test procedure to verify current alarm operation will include simulating a transducer input signal and varying this signal:

1. to exceed over Alert/Alarm 1 and Danger/Alarm 2 Setpoints.
2. to drop below any under Alert/Alarm 1 and Danger/Alarm 2 Setpoints.
3. to produce a nonalarm condition.

Peak to Peak

1. Disconnect PWR, COM, and SIG field wiring from the channel terminals on the I/O module.
2. Connect test equipment and run software as described in Section 5.1.6.1 (Test Equipment and Software Setup - Eccentricity).
3. Adjust the function generator amplitude such that the signal level does not exceed any setpoint value for the pp mil bar graph.
4. Press the RESET switch on the Rack Interface Module (RIM). Verify that the OK LED is on, the bar graph indicator for pp is green, and the Current Value field has no alarm indication.
5. Adjust the function generator amplitude such that the signal just exceeds the pp Over Alert/Alarm 1 setpoint level. Wait for 2 or 3 seconds after the alarm time delay expires and verify that the bar graph indicator for pp changes color from green to yellow and that the Current Value Field indicates an Alarm.
6. Press the RESET switch on the Rack Interface Module (RIM). Verify that the bar graph indicator for pp remains yellow and that the Current Value Field still indicates an Alarm.
7. Adjust the function generator amplitude such that the signal just exceeds the pp Over Danger/Alarm 2 setpoint level. Wait for 2 or 3 seconds after the alarm time delay expires and verify that the bar graph indicator for pp changes color from yellow to red and that the Current Value Field indicates an Alarm.
8. Press the RESET switch on the Rack Interface Module (RIM). Verify that the bar graph indicator for pp remains red and the Current Value Field still indicates an Alarm.
9. Adjust the function generator amplitude such that the signal reads below the Over Alarm setpoint levels. If the nonlatching option is configured, observe that the bar graph indicator for pp changes color to green and

that the Current Value Box contains no indication of alarms. Press the RESET switch on the Rack Interface Module (RIM) to reset latching alarms.

10. If you can not verify any configured alarm, recheck the configured setpoints. If the monitor still does not alarm properly or fails any other part of this test, go to Section 5.1.10 (If a Channel Fails a Verification Test).
11. Disconnect the test equipment and reconnect the PWR, COM, and SIG field wiring to the channel terminals on the I/O module. Verify that the OK LED comes on and the OK relay energizes. Press the RESET switch on the Rack Interface Module (RIM) to reset the OK LED.
12. Repeat steps 1 through 11 for all configured channels.

Gap

1. Disconnect PWR, COM, and SIG field wiring from the channel terminals on the I/O module.
2. Connect test equipment and run software as described in section 5.1.6.1 (Test Equipment and Software Setup - Eccentricity).
3. Adjust the power supply to produce a voltage that is within the Gap setpoint levels on the Gap bar graph display of the Verification screen.
4. Press the RESET switch on the Rack Interface Module (RIM). Verify that the OK LED is on, the bar graph indicator for Gap is green, and the Current Value still has no alarm indication.
5. Adjust the power supply voltage such that the signal just exceeds the Gap Over Alert/Alarm 1 setpoint level. Wait for 2 or 3 seconds after the alarm time delay expires and verify that the bar graph indicator for Gap changes color from green to yellow and that the Current Value Field indicates an Alarm.
6. Press the RESET switch on the Rack Interface Module (RIM). Verify that the bar graph indicator for Gap remains yellow and that the Current Value Field still indicates an Alarm.
7. Adjust the power supply such that the signal just exceeds the Gap Over Danger/Alarm 2 setpoint level. Wait for 2 or 3 seconds after the alarm time delay expires and verify that the bar graph indicator for Gap changes

color from yellow to red and that the Current Value Field indicates an Alarm.

8. Press the RESET switch on the Rack Interface Module (RIM). Verify that the bar graph indicator for Gap remains red and that the Current Value Field still indicates an Alarm.
9. Adjust the power supply voltage such that the signal reads below the Over Alarm setpoint levels. If the nonlatching option is configured, observe that the bar graph indicator for Gap changes color to green and that the Current Value Box contains no indication of alarms. Press the RESET switch on the Rack Interface Module (RIM) to reset latching alarms.
10. Repeat steps 3 through 9 to test the Under Alert/Alarm 1 and Under Danger/Alarm 2 setpoints by adjusting the power supply to exceed the Under Alarm setpoint levels.
11. If you can not verify any configured alarm, recheck the configured setpoints. If the monitor still does not alarm properly or fails any other part of this test, go to Section 5.1.10 (If a Channel Fails a Verification Test).
12. Disconnect the test equipment and reconnect the PWR, COM, and SIG field wiring to the channel terminals on the I/O module. Verify that the OK LED comes on and the OK relay energizes. Press the RESET switch on the Rack Interface Module (RIM) to reset the OK LED.
13. Repeat steps 1 through 12 for all configured channels.

Direct

Note

The Keyphasor must be triggering and have a valid rpm value to check this parameter.
--

1. Disconnect PWR, COM, and SIG field wiring from the channel terminals on the I/O module.
2. Connect test equipment and run software as described in section 5.1.6.1 (Test Equipment and Software Setup - Eccentricity).
3. Adjust the power supply to produce a reading that is within the Direct setpoint levels on the Direct bar graph display of the Verification screen.

4. Press the RESET switch on the Rack Interface Module (RIM). Verify that the OK LED is on, the bar graph indicator for Direct is green, and the Current Value field has no alarm indication.
5. Adjust the power supply voltage such that the signal just exceeds the Direct Over Alert/Alarm 1 setpoint level. Wait for 2 or 3 seconds after the alarm time delay expires and verify that the bar graph indicator for Direct changes color from green to yellow and that the Current Value Field indicates an Alarm.
6. Press the RESET switch on the Rack Interface Module (RIM). Verify that the bar graph indicator for Direct remains yellow and that the Current Value Field still indicates an Alarm.
7. Adjust the power supply such that the signal just exceeds the Direct Over Danger/Alarm 2 setpoint level. Wait for 2 or 3 seconds after the alarm time delay expires and verify that the bar graph indicator for Direct changes color from yellow to red and that the Current Value Field indicates an Alarm.
8. Press the RESET switch on the Rack Interface Module (RIM). Verify that the bar graph indicator for Direct remains red and that the Current Value Field still indicates an Alarm.
9. Adjust the power supply voltage such that the signal reads below the Over Alarm setpoint levels. If the nonlatching option is configured, observe that the bar graph indicator for Direct changes color to green and that the Current Value Box contains no indication of alarms. Press the RESET switch on the Rack Interface Module (RIM) to reset latching alarms.
10. Repeat steps 3 through 9 to test the Under Alert/Alarm 1 and Under Danger/Alarm 2 setpoints by adjusting the power supply to exceed the Under Alarm setpoint levels.
11. If you can not verify any configured alarm, recheck the configured setpoints. If the monitor still does not alarm properly or fails any other part of this test, go to Section 5.1.10 (If a Channel Fails a Verification Test).
12. Disconnect the test equipment and reconnect the PWR, COM, and SIG field wiring to the channel terminals on the I/O module. Verify that the OK LED comes on and the OK relay energizes. Press the RESET switch on the Rack Interface Module (RIM) to reset the OK LED.

13. Repeat steps 1 through 12 for all configured channels.

5.1.6.3 Verify Channel Values - Eccentricity

The general approach for testing these parameters is to simulate the eccentricity signal with a function generator and power supply. The output levels are verified by varying the output from the test equipment and observing that the correct results are reported in the Verification screen on the test computer.

Peak to Peak

1. Disconnect PWR, COM, and SIG field wiring from the channel terminals on the I/O module.
2. Connect test equipment and run software as described in section 5.1.6.1 (Test Equipment and Software Setup - Eccentricity).
3. Calculate the full-scale voltage according to the following equation and examples.

Verification Input Signal =
Peak to Peak Meter Full-scale \times Transducer Scale Factor

Note

Use the Transducer Scale Factor displayed in the Scale Factor Box on the Verification Screen.

Example 1:

Peak to Peak Meter Top Scale = 10 mil

Transducer Scale Factor = 200 mV/mil

Full Scale = (10×0.200)
= 2.000 Vpp

For Vrms input:

Vrms = $(0.707/2) \times (Vpp)$, for a sinewave input
= $(0.707/2) \times (2)$
= 0.707 Vrms

Example 2:

Peak to Peak Meter Top Scale = 200 μm
Transducer Scale Factor = 7,874 mV/mm
= 7.874 mV/ μm

Full Scale = (200 \times 0.007874)
= 1.5748 Vpp

For Vrms input:

Vrms = (0.707/2) \times (Vpp), for a sinewave input
= (0.707/2) \times (1.574)
= 0.5566 Vrms

4. Adjust the function generator amplitude for the calculated full scale. Verify that the pp bar graph display and the Current Value Box is reading ± 1 % of full scale. If the recorder output is configured, refer to Section 5.1.9 (Verify Recorder Outputs) for steps to verify recorder outputs.
5. If the reading does not meet specifications, check that the input signal is correct. If the monitor still does not meet specifications or fails any other part of this test, go to Section 5.1.10 (If a Channel Fails a Verification Test).
6. Disconnect the test equipment and reconnect the PWR, COM, and SIG field wiring to the channel terminals on the I/O module. Verify that the OK LED comes on and the OK relay energizes. Press the RESET switch on the Rack Interface Module (RIM) to reset the OK LED.
7. Repeat steps 1 through 6 for all configured channels.

Gap

1. Disconnect PWR, COM, and SIG field wiring from the channel terminals on the I/O module.
2. Connect test equipment and run software as described in section 5.1.6.1 (Test Equipment and Software Setup - Eccentricity).

3. Adjust the power supply to produce a voltage equal to -18.00 Vdc on the Gap bar graph display. Verify that the Gap bar graph display and the Current Value Box is reading ± 1 % of -18.00 Vdc. If the recorder output is configured, refer to Section 5.1.9 (Verify Recorder Outputs) for steps to verify the recorder output.
4. Adjust the power supply to produce a voltage equal to the mid-scale on the Gap bar graph display. Verify that the Gap bar graph display and current value box is reading ± 1 % of the mid-scale value. If the recorder output is configured, refer to Section 5.1.9 (Verify Recorder Outputs) for steps to verify the recorder output.
5. If the reading does not meet specifications, check that the input signal is correct. If the monitor still does not meet specifications or fails any other part of this test, go to Section 5.1.10 (If a Channel Fails a Verification Test).
6. Disconnect the test equipment and reconnect the PWR, COM, and SIG field wiring to the channel terminals on the I/O module. Verify that the OK LED comes on and the OK relay energizes. Press the RESET switch on the Rack Interface Module (RIM) to reset the OK LED.
7. Repeat steps 1 through 6 for all configured channels.

Direct

<p style="text-align: center;">Note</p> <p>The Keyphasor must be triggering and have a valid rpm value to check this parameter.</p>
--

1. Disconnect PWR, COM, and SIG field wiring from the channel terminals on the I/O module.
2. Connect test equipment and run software as described in section 5.1.6.1 (Test Equipment and Software Setup - Eccentricity).
3. Calculate the full-scale and bottom-scale values. These values can be calculated in the following way:

$$\text{Full / Bottom Scale Value} = \text{Zero Position Voltage} \pm (\text{Transducer Scale Factor} \times \text{Scale Range})$$

Note

The Zero Position Voltage is the voltage input that will cause the reading on the bar graph display and the Current Value Box to be zero. The Zero Position Volts value is displayed in the Z.P. Volts box above each channel value bar graph.

Note

Use the Transducer Scale Factor displayed in the Scale Factor Box on the Verification Screen.

Full Scale =

$$(\text{Zero Position Voltage}) - (\text{Transducer Scale Factor} \times \text{Top Meter Scale})$$

Bottom Scale =

$$(\text{Zero Position Voltage}) + (\text{Transducer Scale Factor} \times \text{ABS (Bottom Meter Scale)})$$

Example 1:

Transducer scale factor = 200 mV/mil

Meter scale range = 20-0-20 mil

Zero Position Voltage = -9.75 Vdc

$$\begin{aligned} \text{Full-Scale Value} &= (-9.75) - (0.200 \times 20) \\ &= -13.75 \text{ Vdc} \end{aligned}$$

$$\begin{aligned} \text{Bottom-Scale Value} &= (-9.75) + (0.200 \times 20) \\ &= -5.75 \text{ Vdc} \end{aligned}$$

Example 2:

Transducer scale factor = 7,874 mV/mm
= 7.874 mV/ μm

Meter scale range = 200-0-200 μm

Zero Position Voltage = -9.75 Vdc

$$\begin{aligned} \text{Full-Scale Value} &= (-9.75) - (0.007874 \times 200) \\ &= -11.3248 \text{ Vdc} \end{aligned}$$

$$\begin{aligned} \text{Bottom-Scale Value} &= (-9.75) + (0.007874 \times 200) \\ &= -8.1752 \text{ Vdc} \end{aligned}$$

4. Adjust the power supply voltage to match the voltage displayed in the Z.P.

Volts Box. The Direct bar graph display and the Current Value Box should read 0 mil (0 mm) ± 1 %.

5. Adjust the power supply voltage for full scale. Verify that the Max value in the Current Value Box (the value on the left of the divider bar) is reading ± 1 % of full scale. If the recorder output is configured, refer to Section 5.1.9 (Verify Recorder Outputs) for steps to verify the recorder output.
6. Adjust the power supply voltage for bottom scale. Verify that the Min value in the Current Value Box (the value on the right of the divider bar) is reading ± 1 % of bottom scale. If the recorder output is configured, refer to Section 5.1.9 (Verify Recorder Outputs) for steps to verify the recorder output.
7. If the reading does not meet specifications, check that the input signal is correct. If the monitor still does not meet specifications or fails any other part of this test, go to Section 5.1.10 (If a Channel Fails a Verification Test).
8. Disconnect the power supply and multimeter and reconnect the PWR, COM, and SIG field wiring to the channel terminals on the I/O module. Verify that the OK LED comes on and the OK relay energizes. Press the RESET switch on the Rack Interface Module (RIM) to reset the OK LED.
9. Repeat steps 1 through 8 for all configured channels.

5.1.6.4 Test OK Limits - Eccentricity

The general approach for testing OK limits is to input a DC voltage and adjust it above the Upper OK limit and below the Lower OK limit. This will cause a channel not OK condition and the OK Relay to change state (de-energize). The Upper and Lower OK limits are displayed in the Verification screen on the test computer.

1. Disconnect PWR, COM, and SIG field wiring from the channel terminals on the I/O module.
2. Connect test equipment and run software as described in section 5.1.6.1 (Test Equipment and Software Setup - Eccentricity).
3. Bypass all other configured channels.
4. Adjust the power supply voltage to -7.00 Vdc.
5. Press the RESET switch on the Rack Interface Module (RIM). Verify that the

monitor OK LED is on and that the Channel OK State line in the Channel Status box of the Verification screen reads **OK**.

Note

If the Danger Bypass has been activated, then the BYPASS LED will be on. All other channels in the rack must be OK or bypassed for the relay to be energized.

6. Verify that the OK relay on the Rack Interface I/O Module indicates OK (energized). See 3500/20 Rack Interface Module Operation and Maintenance Manual, part number 129768-01.
7. Increase the power supply voltage (more negative) until the OK LED just goes off (upper limit). Verify that the Channel OK State line in the Channel Status box reads **not OK** and that the OK Relay indicates not OK. Verify that the Upper OK limit voltage displayed on the Verification screen is equal to or more positive than the input voltage.
8. Decrease the power supply voltage (less negative) to -7.00 Vdc.
9. Press the RESET switch on the Rack Interface Module (RIM). Verify that the OK LED comes back on and the OK relay energizes and that the Channel OK State line in the Channel Status box reads **OK**.
10. Gradually decrease the power supply voltage (less negative) until the OK LED just goes off (lower limit). Verify that the Channel OK State line in the Channel Status box reads **not OK** and that the OK Relay indicates not OK. Verify that the Lower OK limit voltage displayed on the Verification screen is equal to or more negative than the input voltage.
11. Increase the power supply voltage (more negative) to -7.00 Vdc.
12. Press the RESET switch on the Rack Interface Module (RIM). Verify that the OK LED comes back on, the OK relay energizes, and the Channel OK State line in the Channel Status box reads **OK**.
13. If you can not verify any configured OK limit, go to Section 5.1.10 (If a Channel Fails a Verification Test).
14. Disconnect the test equipment and reconnect the PWR, COM, and SIG field wiring to the channel 1 terminals on the Monitor I/O Module. Press the RESET switch on the Rack Interface Module (RIM) and verify that the OK LED comes on and the OK relay energizes.

15. Repeat steps 1 through 14 for all configured channels.

16. Return the bypass switch for all configured channels back to their original setting.

Eccentricity Default OK Limits Table

Transducer	Lower OK Limit (volts)	Upper OK Limit (volts)
7200 5 & 8 mm w/ barriers	-2.70 to -2.80	-16.70 to -16.80
7200 5 & 8 mm w/o barriers	-2.70 to -2.80	-16.70 to -16.80
7200 11 mm w/o barriers	-3.50 to -3.60	-19.60 to -19.70
7200 14 mm w/o barriers	-2.70 to -2.80	-16.70 to -16.80
3300 5 & 8 mm w/ barriers	-2.70 to -2.80	-16.70 to -16.80
3300 5 & 8 mm w/o barriers	-2.70 to -2.80	-16.70 to -16.80
3300 16 mm HTPS w/o barriers	-2.70 to -2.80	-16.70 to -16.80

Note: Assume ± 50 mV accuracy for check tolerance.

5.1.7 Velocity Channels

The following sections will describe how to test alarms, verify channels, verify filter corner frequencies, and test OK limits for channels configured as Velocity. The output values and alarm setpoints are verified by varying the input signal level and observing that the correct results are reported in the Verification screen on the test computer.

Velocity channels can be configured for the following channel values and alarms:

Channel Values	Alarms	
	Over	Under
Direct	X	

5.1.7.1 Test Equipment and Software Setup - Velocity

The following test equipment and software setup can be used as the initial set up needed for all the verification procedures (Test Alarms, Verify Channels, Verify Filter Corner Frequencies, and Test OK Limits).

 WARNING	Application Alert
High voltage present. Contact could cause shock, burns, or death. Do not touch exposed wires or terminals.	Tests will exceed alarm setpoint levels causing alarms to activate. This could result in a relay contact state change.
Application Alert	
Disconnecting the field wiring will cause a not OK condition.	

Test Equipment Setup - Seismoprobe

Simulate the transducer signal by connecting the power supply, function generator, and multimeter to COM and SIG / A of channel 1 with polarity as shown in the figure on page 173 (Seismoprobe Test Setup). Set the test equipment as specified below:

Power Supply	Function Generator
-6.50 Vdc	Waveform: sinewave DC Volts: 0 Vdc Frequency: 100 Hz Amplitude level: Minimum (above zero)

Test Equipment Setup - Velomitor (Standard I/O)

Simulate the transducer signal by connecting the power supply, function generator, and multimeter to COM and SIG / A of channel 1 with polarity as shown in the figure on page 174 (Velomitor Test Setup Standard I/O). Set the test equipment as specified below.

Function Generator

Waveform: sinewave

DC Volts: 0 Vdc

Frequency: 100 Hz

Amplitude level: Minimum (above zero)

Test Equipment Setup - Velomitor (TMR I/O)

Simulate the transducer signal by connecting the power supply, function generator, and multimeter to COM / A and SIG / B of channel 1 with polarity as shown in the figure on page 176 (Velomitor Test Setup TMR I/O). Set the test equipment as specified below.

Function Generator
Waveform: sinewave
DC Volts: 0 Vdc
Frequency: 100 Hz
Amplitude level: Minimum (above zero)

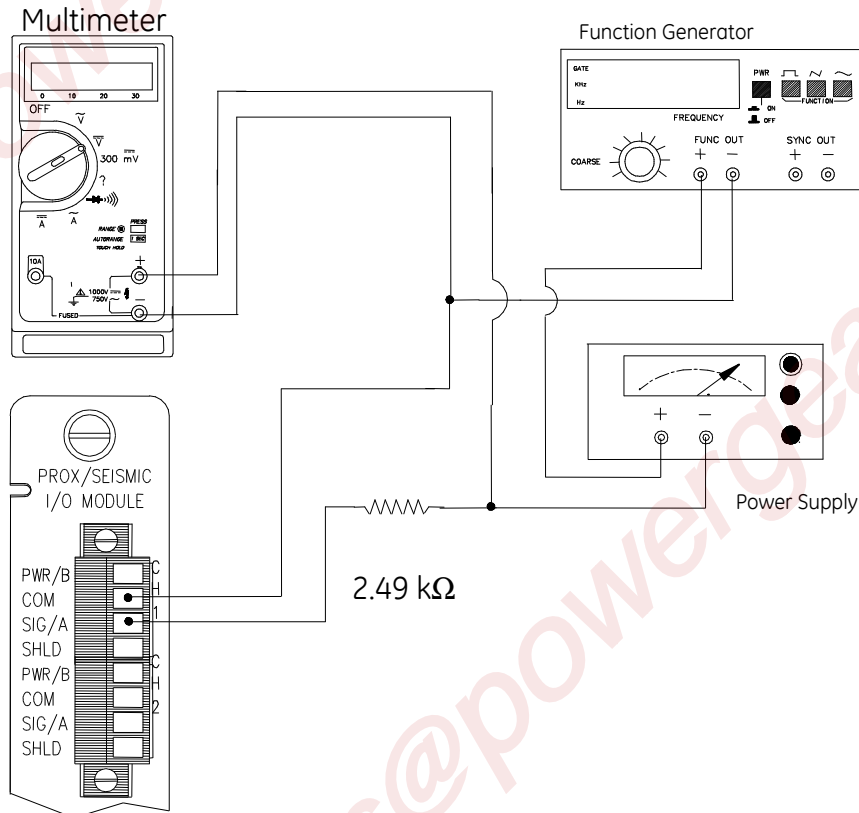

Seismoprobe Test Setup

The Test Equipment outputs should be floating relative to earth ground.

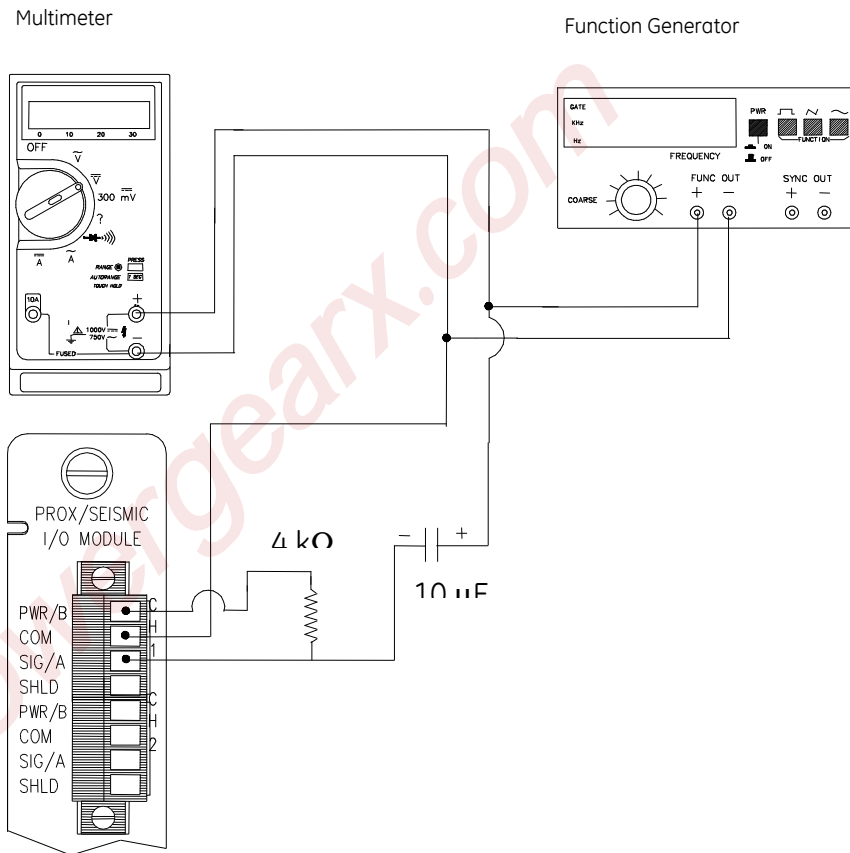

Velomitor Test Setup With Standard I/O

The Test Equipment outputs should be floating relative to earth ground.

Multimeter

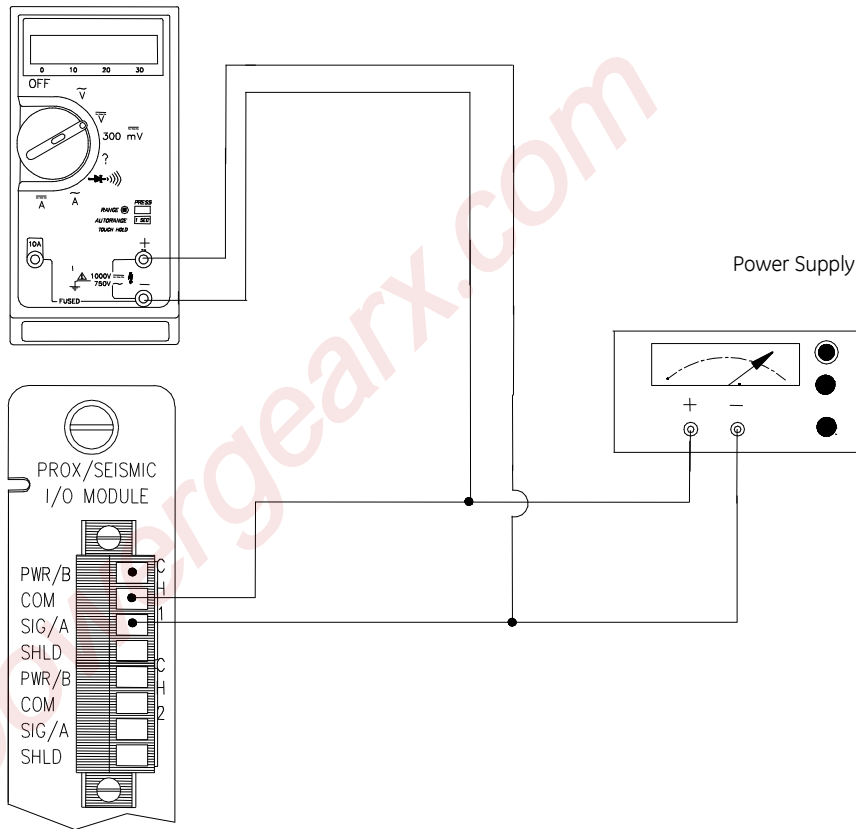

Test Setup for Verifying the OK Limits of a Velomitor With Standard I/O.

The Test Equipment outputs should be floating relative to earth ground.

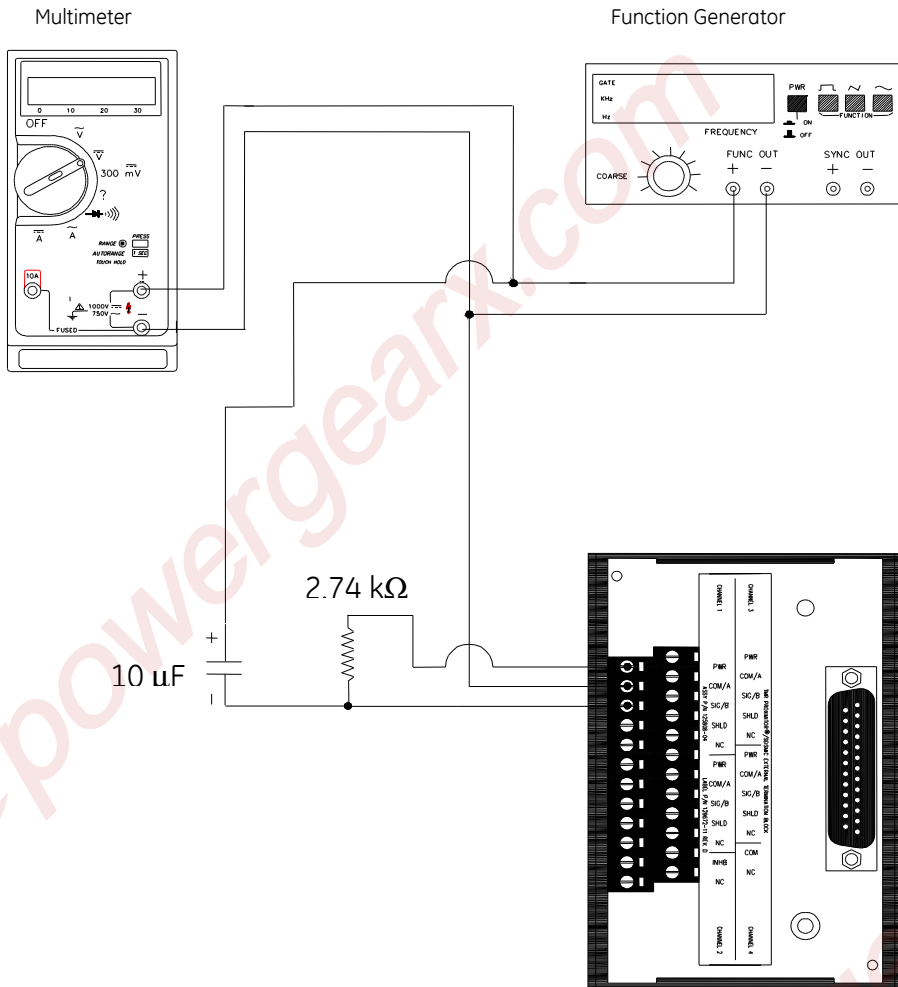

Velomitor Test Setup With TMR I/O

The Test Equipment outputs should be floating relative to earth ground.

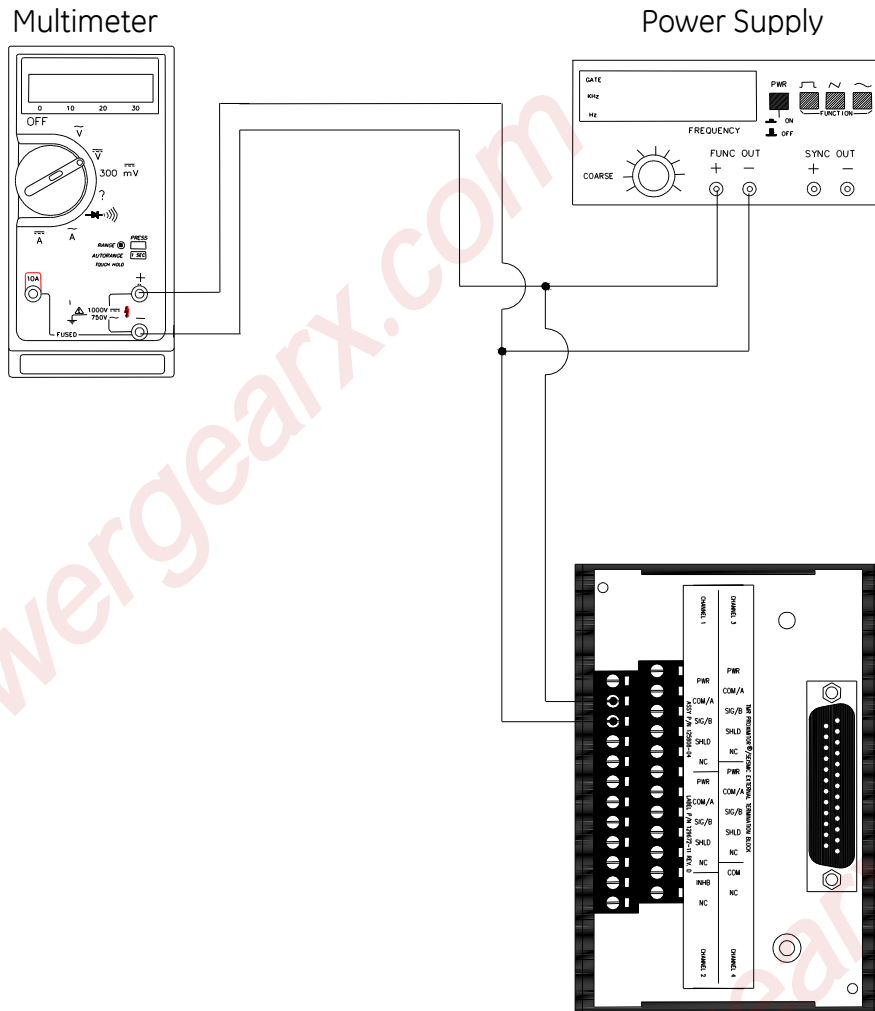

Test Setup for Verifying the OK Limits of a Velomitor With TMR I/O

The Test Equipment outputs should be floating relative to earth ground.

Verification Screen Setup - Velocity

Run the Rack Configuration Software on the test computer. Choose **Verification** from the Utilities menu and choose the proper Slot number and Channel number then click on the **Verify** button.

Note

If the Timed OK Channel Defeat is enabled, it will take 30 seconds for a channel to return to the **OK** status from **not OK**. If OK MODE is configured for latching, press the RESET button on the Rack Interface Module (RIM) to return to **OK** status.

The following table directs you to the starting page of each maintenance section associated with the Velocity Channels.

Section Number	Topic	Page Number
5.1.7.2	Test Alarms - Direct	179
5.1.7.3	Verify Channel Values - Direct	181
5.1.7.4	Verify Filter Corner Frequencies	182
5.1.7.7	Test OK Limits	188

5.1.7.2 Test Alarms - Velocity

The general approach for testing alarm setpoints is to simulate the Velocity signal with a function generator and power supply. The alarm levels are tested by varying the output from the test equipment and observing that the correct results are reported in the Verification screen on the test computer. It is only necessary to test those alarm parameters that are configured and being used. The general test procedure to verify current alarm operation will include simulating a transducer input signal and varying this signal:

1. to exceed over Alert/Alarm 1 and Danger/Alarm2 Setpoints, and
 2. to drop below any under Alert/Alarm 1 and Danger/Alarm 2 Setpoints,
- and
3. to produce a nonalarm condition.

When varying the signal from an alarm condition to a nonalarm condition, alarm hysteresis must be considered. Adjust the signal well below the alarm setpoint for the alarm to clear.

Direct

1. Disconnect PWR / B, COM, and SIG / A (PWR, COM / A, and SIG / B for TMR I/O) field wiring from the channel terminals on the I/O module.
2. Connect test equipment:

For Seismoprobe:

Connect test equipment and run software as described in section 5.1.7.1 (Test Equipment and Software Setup - Velocity), use the setup shown on page 173 (Seismoprobe Test Setup). If no filtering has been configured, leave the frequency of the function generator set to 100 Hz. If filtering is configured, the needed frequency can be calculated from the following formula:

$$\text{Frequency} = (0.89 \times \text{HPF}) + (0.1575 \times \text{LPF})$$

HPF = High-pass Filter Corner Frequency

LPF = Low-pass Filter Corner Frequency

If no filtering is configured, set the frequency of the function generator to 100 Hz.

If a Low-pass Filter is configured and no High-pass Filter is configured, use the following to determine the HPF to use in the formula:

- If the units are RMS, use a HPF of 10 Hz. For any other configuration, use a HPF of 3 Hz.

If a High-pass Filter is configured and no Low-pass Filter is configured, use a LPF of 5,500 Hz.

Set the frequency of the function generator to this new value. The above is done to obtain a test frequency in the center of the channel frequency range.

For Velomitor:

Connect test equipment and run software as described in section 5.1.7.1 (Test Equipment and Software Setup - Velocity), use the setup shown on page 174 (Velomitor Test Setup, Standard I/O) or page 176 for TMR I/O. If no filtering has been configured, leave the frequency of the function generator set to 100 Hz. If filtering is configured, calculate the needed frequency from the following formula:

$$\text{Frequency} = (0.89 \times \text{HPF}) + (0.1575 \times \text{LPF})$$

HPF = High-pass Filter Corner Frequency

LPF = Low-pass Filter Corner Frequency

If a low-pass filter is configured and no high-pass filter is configured, use
HPF = 3 Hz

If a high-pass filter is configured and no low-pass filter is configured, use
LPF = 5,500 Hz

Set the frequency of the function generator to this new value. The above is done to obtain a test frequency in the center of the channel frequency range.

3. Adjust the function generator amplitude to produce a reading that is below the Direct setpoint levels on the Direct bar graph display of the Verification screen.
4. Press the RESET switch on the Rack Interface Module (RIM). Verify that the OK LED is on, the bar graph indicator for Direct is green, and the Current Value field contains no alarm indication.
5. Adjust the function generator amplitude such that the signal just exceeds the Direct Over Alert/Alarm 1 setpoint level. Wait for 2 or 3 seconds after the alarm time delay expires and verify that the bar graph indicator for Direct changes color from green to yellow and the Current Value Field indicates an Alarm.
6. Press the RESET switch on the Rack Interface Module (RIM). Verify that the bar graph indicator for Direct remains yellow and that the Current Value Field still indicates an Alarm.
7. Adjust the function generator amplitude such that the signal just exceeds the Direct Over Danger/Alarm 2 setpoint level. Wait for 2 or 3 seconds

after the alarm time delay expires and verify that the bar graph indicator for Direct changes color from yellow to red and that the Current Value Field indicates an Alarm.

8. Press the RESET switch on the Rack Interface Module (RIM). Verify that the bar graph indicator for Direct remains red and that the Current Value Field still indicates an Alarm.
9. Adjust the function generator amplitude such that the signal reads below the Over Alarm setpoint levels. If the nonlatching option is configured, observe that the bar graph indicator for Direct changes color to green and that the Current Value Box contains no indication of alarms. Press the RESET switch on the Rack Interface Module (RIM) to reset latching alarms.
10. If you can not verify any configured alarm, recheck the configured setpoints. If the monitor still does not alarm properly or fails any other part of this test, go to Section 5.1.10 (If a Channel Fails a Verification Test).
11. Disconnect the test equipment and reconnect the PWR / B, COM, and SIG / A (PWR, COM / A, and SIG / B for TMR I/O) field wiring to the channel terminals on the I/O module. Verify that the OK LED comes on and the OK relay energizes. Press the RESET switch on the Rack Interface Module (RIM) to reset the OK LED.
12. Repeat steps 1 through 11 for all configured channels.

5.1.7.3 Verify Channel Values - Velocity

The general approach for testing these parameters is to simulate the velocity signal with a function generator and power supply. The channel values are verified by varying the output from the test equipment and observing that the correct results are reported in the Verification screen on the test computer.

Note

These parameters have an accuracy specification of $\pm 1\%$ of full-scale.

Direct

1. Disconnect PWR / B, COM, and SIG / A (PWR, COM / A, and SIG / B for TMR I/O) field wiring from the channel terminals on the I/O module.
2. Connect test equipment and run software as described in Section 5.1.7.1 (Test Equipment and Software Setup - Velocity).

3. Calculate the verification frequency using the formulas in Section 5.1.7.5, page 184. Adjust the function generator frequency to the calculated value.
4. Calculate the full-scale voltage using the procedure in Section 5.1.7.6, page 184. Adjust the function generator (sinewave) amplitude to the calculated value.
5. Verify that the Direct bar graph display and the Current Value Box is reading $\pm 1\%$ of full-scale. If the recorder output is configured, refer to Section 5.1.9 (Verify Recorder Outputs) for steps to verify the recorder output).
6. If the reading does not meet specifications, check that the input signal is correct. If the monitor still does not meet specifications or fails any other part of this test, go to Section 5.1.10 (If a Channel Fails a Verification Test).
7. Disconnect the test equipment and reconnect the PWR / B, COM, and SIG / A (PWR, COM / A, and SIG / B for TMR I/O) field wiring to the channel terminals on the I/O module. Verify that the OK LED comes on and the OK relay energizes. Press the RESET switch on the Rack Interface Module (RIM) to reset the OK LED.
8. Repeat steps 1 through 7 for all configured channels.

5.1.7.4 Verify Filter Corner Frequencies

The general approach for testing these parameters is to simulate the Velocity signal with a function generator and power supply. The corner frequencies are verified by varying the output from the test equipment and observing that the correct results are reported in the Verification screen on the test computer.

Note

If the channel units are integrated, change the channel configuration to a non-integrated scale for this test. When the test is complete, return the channel to its original configuration.

1. Disconnect PWR / B, COM, and SIG / A (PWR, COM / A, and SIG / B for TMR I/O) field wiring from the channel terminals on the I/O module.
2. Connect test equipment and run software as described in Section 5.1.7.1 (Test Equipment and Software Setup - Velocity).

3. Calculate the verification frequency using the formulas in Section 5.1.7.5, page 184. Adjust the function generator frequency to the calculated value.
4. Calculate the full-scale voltage using the procedure in Section 5.1.7.6, page 184. Adjust the function generator (sinewave) amplitude to the calculated value.
5. Verify that the Direct bar graph display and the Current Value Box is reading full-scale.
6. Adjust the function generator frequency to the low-pass filter corner frequency. Verify that the Direct bar graph display and the Current Value Box is reading between 65 % and 75 % of full-scale.
7. Adjust the function generator frequency to the high-pass filter corner frequency. Verify that the Direct bar graph display and the Current Value Box is reading between 65 % and 75 % of full-scale.
8. If the reading does not meet specifications, check that the input signal is correct. If the monitor still does not meet specifications or fails any other part of this test, go to Section 5.1.10 (If a Channel Fails a Verification Test).
9. Disconnect the test equipment and reconnect the PWR / B, COM, and SIG / A (PWR, COM / A, and SIG / B for TMR I/O) field wiring to the channel terminals on the I/O module. Verify that the OK LED comes on and the OK relay energizes. Press the RESET switch on the Rack Interface Module (RIM) to reset the OK LED.
10. Repeat steps 1 through 9 for all configured channels.

5.1.7.5 Calculating Verification Frequency

The procedures for verifying channel values and corner frequencies require that you use the following formulas to calculate the verification frequency:

Find the center of the Band-pass frequency range. Input the configured High-pass Filter Corner Frequency and the Low-pass Filter Corner Frequency into the formula below:

$$\text{Vibration Frequency} = (0.89 \times \text{HPF}) + (0.1575 \times \text{LPF})$$

HPF = High-pass Filter Corner Frequency

LPF = Low-pass Filter Corner Frequency

If no filtering is configured, set the frequency of the function generator to 100 Hz.

If a Low-pass Filter is configured and no High-pass Filter is configured, use the following to determine the HPF to use in the formula:

- If the units are RMS, use a HPF of 10 Hz. For any other configuration, use a HPF of 3 Hz.

If a High-pass Filter is configured and no Low-pass Filter is configured, use a LPF of 5,500 Hz.

5.1.7.6 Calculating the Input Voltage for Full-scale

The procedures for verifying channel values and corner frequencies require that you use the following formulas to calculate the input voltage for Full-scale. To find the Full-scale input voltage, use appropriate table or formula for integrated or non-integrated units.

Note

Use the Transducer Scale Factor displayed in the Scale Factor Box on the Verification screen.

Full Scale Formulas - No Integration

Units	To Input RMS Volts	To Input Peak to Peak Volts
in/s pk	$(T.S.F \times \text{Full-scale}) \times 0.707$	$(T.S.F \times \text{Full-scale}) \times 2$
mm/s pk	$(T.S.F \times \text{Full-scale}) \times 0.707$	$(T.S.F \times \text{Full-scale}) \times 2$
in/s rms	$(T.S.F \times \text{Full-scale})$	$(T.S.F \times \text{Full-scale}) \times 2.82$
mm/s rms	$(T.S.F \times \text{Full-scale})$	$(T.S.F \times \text{Full-scale}) \times 2.82$

To use the formulas, the T.S.F. should be in volts and the T.S.F and full-scale values should both be of the same unit system (metric or English). The transducer Scale Factor will always be specified as volts per inch/second pk or volts per millimetre/second pk.

Example 1:

Transducer Scale Factor = 500 mV/(in/s)

Full Scale = 0.5 in/s pk

For Peak to Peak input:

$$(0.500 \times 0.5) \times 2 = 0.5 \text{ Vpp}$$

For Vrms input:

$$(0.500 \times 0.5) \times 0.707 = 0.1767 \text{ Vrms}$$

Example 2:

Transducer Scale Factor = 19.69 mV/(mm/s)

Full Scale = 20 mm/s pk

For Peak to Peak input:

$$(0.01969 \times 20) \times 2 = 0.7876 \text{ Vpp}$$

For RMS input:

$$(0.01969 \times 20) \times 0.707 = 0.2784 \text{ Vrms}$$

Full Scale Formulas - Integration

$$\text{Input Voltage (V rms)} = \frac{\text{Full - scale (English units)}}{\left[\frac{31.831}{\text{Scale Factor (English units)}} \right] / \text{Velocity Frequency}} \times 0.07071$$

(0.5V / (inch / s) typical)

$$\text{Input Voltage (V PP)} = \frac{\text{Full - scale (English units)}}{\left[\frac{31.831}{\text{Scale Factor (English units)}} \right] / \text{Velocity Frequency}} \times 0.2$$

(0.5 V / (inch / s) typical)

(For the following units: mil pp and μm pp)

To use the formulas, the Velocity Scale Factor should be in volts, and the Full-scale value and Velocity Scale Factor should be in English units. Use the following

$$\text{Velocity Scale Factor (inch / s)} = \frac{\text{VelocityScaleFactor (mm / s)}}{25.4}$$

conversion formulas to convert Metric units to English units:

$$\text{Full - Scale (mil)} = \frac{\text{Full - scale (μm)}}{25.4}$$

Scale Factor:

Full-scale:

Example:

To calculate the input voltage for a channel with the following configuration:

Transducer Scale Factor = 19.69 mV/(mm/s)

Full Scale = 100 μm pp

HPF = 3 Hz

LPF = 3000 Hz

1. Convert Metric units to English units.

Scale Factor:

$$\frac{100 \mu\text{m}}{25.4} = 3.9370 \text{ mil}$$

$$\begin{aligned} \text{Input Voltage (V rms)} &= \frac{3.9370}{\left[\left(\frac{31.8309}{0.500} \right) / 94.8683 \right]} \times 0.07071 = 0.4148 \text{ V rms} \end{aligned}$$

$$\begin{aligned} \text{Input Voltage (V pp)} &= \frac{3.9370}{\left[\left(\frac{31.8309}{0.500} \right) / 94.8683 \right]} \times 0.2 = 1.173 \text{ V pp} \end{aligned}$$

$$19.69 \text{ mV}/(\text{mm}/\text{s}) \times 25.4 = 500 \text{ mV}/(\text{in}/\text{s})$$

Full-scale:

2. Calculate the input voltage.

or

Note

The accuracy of the reading will be affected by frequency values less than 20 Hz and setting LPF 5.7 times away from the HPF.

5.1.7.7 Test OK Limits - Velocity

Note

If the Danger Bypass has been activated, then the BYPASS LED will be on. All other channels in the rack must be OK or bypassed for the OK relay to be energized.

For Seismoprobes:

The general approach for testing OK limit is to disconnect the input. This will cause a not OK condition and the OK Relay to change state (de-energize).

1. Run the Verification Software as described in Section 5.1.7.1 (Test Equipment and Software Setup - Velocity).
2. Disconnect the SIG / A field wiring from the channel terminals on the Proximator / Seismic Monitor I/O Module.
3. Verify that the OK relay changes state (de-energized).
4. Verify that the Channel OK State line on the Verification screen reads **not OK**.
5. Reconnect the SIG / A field wiring to the channel terminals on the Monitor I/O Module. Press the RESET switch on the Rack Interface Module (RIM) and verify that the OK LED comes on and the OK relay energizes.
6. Verify that the Channel OK State line on the Verification screen reads **OK**.
7. If you can not verify any configured OK limit, go to Section 5.1.10 (If a Channel Fails a Verification Test).
8. Repeat steps 1 through 7 for all configured channels.

For Velomiters with Standard I/O Modules:

The general approach for testing OK limits is to input a DC voltage and adjust it above the Upper OK limit and below the Lower OK limit. This will cause a not OK condition and the OK Relay to change state (de-energize). The Upper and Lower OK limits are displayed in the Verification screen on the test computer.

1. Disconnect PWR / B, COM, and SIG / A field wiring from the channel terminals on the I/O module.
2. Connect test equipment and run software as described in Section 5.1.7.1 (Test Equipment and Software Setup - Velocity), page 175.
3. Bypass all other configured channels.
4. Adjust the power supply voltage to -7.00 Vdc.
5. Press the RESET switch on the Rack Interface Module (RIM). Verify that the monitor OK LED is on and that the Channel OK State line in the Channel Status section of the Verification screen reads **OK**.
6. Verify that the OK relay on the Rack Interface I/O Module indicates OK (energized). See the 3500/20 Rack Interface Module Operation and Maintenance Manual, part number 129768-01.
7. Increase the power supply voltage (more negative) until the OK LED just goes off (upper limit). Verify that the Channel OK State line on the Verification screen reads **not OK** and that the OK Relay indicates not OK. Verify that the Upper OK limit voltage displayed on the Verification screen is equal to or more positive than the input voltage.
8. Decrease the power supply voltage (less negative) to -7.00 Vdc.
9. Press the RESET switch on the Rack Interface Module (RIM). Verify that the OK LED comes back on and the OK relay energizes. Verify that the Channel OK State line in the Channel Status section reads **OK**.
10. Gradually decrease the power supply voltage (less negative) until the OK LED just goes off (lower limit). Verify that the Channel OK State line in the Channel Status section reads **not OK** and that the OK Relay indicates not OK. Verify that the Lower OK limit voltage displayed on the Verification screen is equal to or more negative than the input voltage.
11. Increase the power supply voltage (more negative) to -7.00 Vdc.

12. Press the RESET switch on the Rack Interface Module (RIM). Verify that the OK LED comes back on, the OK relay energizes, and the Channel OK State line in the Channel Status section reads **OK**.
13. If you can not verify any configured OK limit, go to Section 5.1.10 (If a Channel Fails a Verification Test).
14. Disconnect the power supply and multimeter and reconnect the PWR, COM, and SIG field wiring to the channel terminals on the Monitor I/O Module. Press the RESET switch on the Rack Interface Module (RIM) and verify that the OK LED comes on and the OK relay energizes.
15. Repeat steps 1 through 14 for all configured channels.
16. Return the bypass switch for all configured channels back to their original setting.

For Velomitors with TMR I/O Modules:

Due to the requirements for increased robustness in the TMR system, the TMR I/O Module has a Velomitor interface that is different from the standard I/O Module's Velomitor interface. The effect of this difference is that the Velomitor signal input to the I/O Module is 180 degrees out of phase from the correct Velomitor signal. This inversion is compensated for in the TMR I/O Module. This means that when you input a test signal using a signal generator or DC power supply the buffered outputs on the front panel will be inverted in phase and will have a different DC voltage than the input. This will not affect the actual vibration readings in the Monitor.

The general approach for testing OK limits is to input a DC voltage and adjust it above the Upper OK limit and below the Lower OK limit. This will cause a not OK condition and the OK Relay to change state (de-energize). The Upper and Lower OK limits are displayed in the Verification screen on the test computer.

1. Disconnect PWR, COM / A, and SIG / B field wiring from the channel terminals on the I/O module.
2. Connect test equipment and run software as described in Section 5.1.7.1 (Test Equipment and Software Setup - Velocity), page 177.
3. Bypass all other configured channels.

4. Adjust the power supply voltage to -7.00 Vdc.
5. Press the RESET switch on the Rack Interface Module (RIM). Verify that the monitor OK LED is on and that the Channel OK State line in the Channel Status section of the Verification screen reads **OK**.
6. Verify that the OK relay on the Rack Interface I/O Module indicates OK (energized). See the 3500/20 Rack Interface Module Operation and Maintenance Manual, part number 129768-01.
7. Increase the power supply voltage (more negative) until the OK LED just goes off (lower limit due to the inversion on the I/O Module). Verify that the Channel OK State line on the Verification screen reads **not OK** and that the OK Relay indicates not OK. Verify that the Lower OK limit voltage displayed on the Verification screen is equal to or more negative than the following value.
8. Decrease the power supply voltage (less negative) to -7.00 Vdc.
9. Press the RESET switch on the Rack Interface Module (RIM). Verify that the OK LED comes back on and the OK relay energizes. Verify that the Channel OK State line in the Channel Status section reads **OK**.

$$\begin{array}{l} \text{Lower OK} \\ \text{Limit Voltage} \end{array} \leq -20.84 - V_{\text{input}}$$

10. Gradually decrease the power supply voltage (less negative) until the OK LED just goes off (upper limit due to the inversion on the I/O Card). Verify that the Channel OK State line in the Channel Status section reads **not OK** and that the OK Relay indicates not OK. Verify that the Upper OK limit

$$\begin{aligned} &Upper\ OK \\ Limit\ Voltage &\geq -22.02 - V_{input} \end{aligned}$$

voltage displayed on the Verification screen is equal to or more positive than the following value.

11. Increase the power supply voltage (more negative) to -7.00 Vdc.
12. Press the RESET switch on the Rack Interface Module (RIM). Verify that the OK LED comes back on, the OK relay energizes, and the Channel OK State line in the Channel Status section reads **OK**.
13. If you can not verify any configured OK limit, go to Section 5.1.10 (If a Channel Fails a Verification Test).
14. Disconnect the power supply and multimeter and reconnect the PWR, COM / A, and SIG / B field wiring to the channel terminals on the Monitor I/O Module. Press the RESET switch on the Rack Interface Module (RIM) and verify that the OK LED comes on and the OK relay energizes.
15. Repeat steps 1 through 14 for all configured channels.
16. Return the bypass switch for all configured channels back to their original setting.

Velocity Default OK Limits Table

Transducer	Lower Ok Limit (volts)	Upper Ok Limit (volts)
9200 w/ &w/o barriers	-2.0 to -2.1	-17.9 to -18.0
86205 w/ & w/o barriers	-2.0 to -2.1	-17.9 to -18.0
47633 w/ & w/o barriers	-2.0 to -2.1	-17.9 to -18.0
non std w/ &w/o barriers	-2.0 to -2.1	-17.9 to -18.0
Velomitor (standard with Internal Barrier or standard I/O Module)	-4.1 to -4.2	-19.8 to -19.9
Velomitor (high temp with Internal Barrier or standard I/O Module)	-2.69 to -2.79	-21.21 to -21.31
Velomitor (standard with TMR I/O Module)	-4.1 to -4.2	-19.8 to -19.9
Velomitor (high temp with TMR I/O Module)	-4.1 to -4.2	-19.8 to -19.9

Note: Assume ± 50 mV accuracy for check tolerance.

5.1.8 Acceleration Channels

The following sections will describe how to test alarms, verify channels, verify filter corner Frequencies, and test OK limits for channels configured as Acceleration. The output values and alarm setpoints are verified by varying the input signal level and observing that the correct results are reported in the Verification screen on the test computer.

Acceleration channels can be configured for the following channel values and alarms:

Channel Values	Alarms	
	Over	Under
Direct	X	

5.1.8.1 Test Equipment and Software Setup - Acceleration

The following test equipment and software setup can be used as the initial setup needed for all the verification procedures (Test Alarms, Verify Channels, Verify Filter Corner Frequencies, and Test OK limits).

 WARNING	Application Alert
<p>High voltage present. Contact could cause shock, burns, or death. Do not touch exposed wires or terminals.</p>	<p>Tests will exceed alarm setpoint levels causing alarms to activate. This could result in a relay contact state change.</p>
Application Alert	
<p>Disconnecting the field wiring will cause a not OK condition.</p>	

Test Equipment Setup - Acceleration

Simulate the transducer signal by connecting the power supply, function generator, and multimeter to COM and SIG / A of channel 1 with polarity as shown in the figure on page 195 (Acceleration Test Setup). Set the test equipment as specified below.

Power Supply	Function Generator
-6.50 Vdc	Waveform: sinewave DC Volts: 0 Vdc Frequency: 100 Hz Amplitude level: Minimum (above zero)

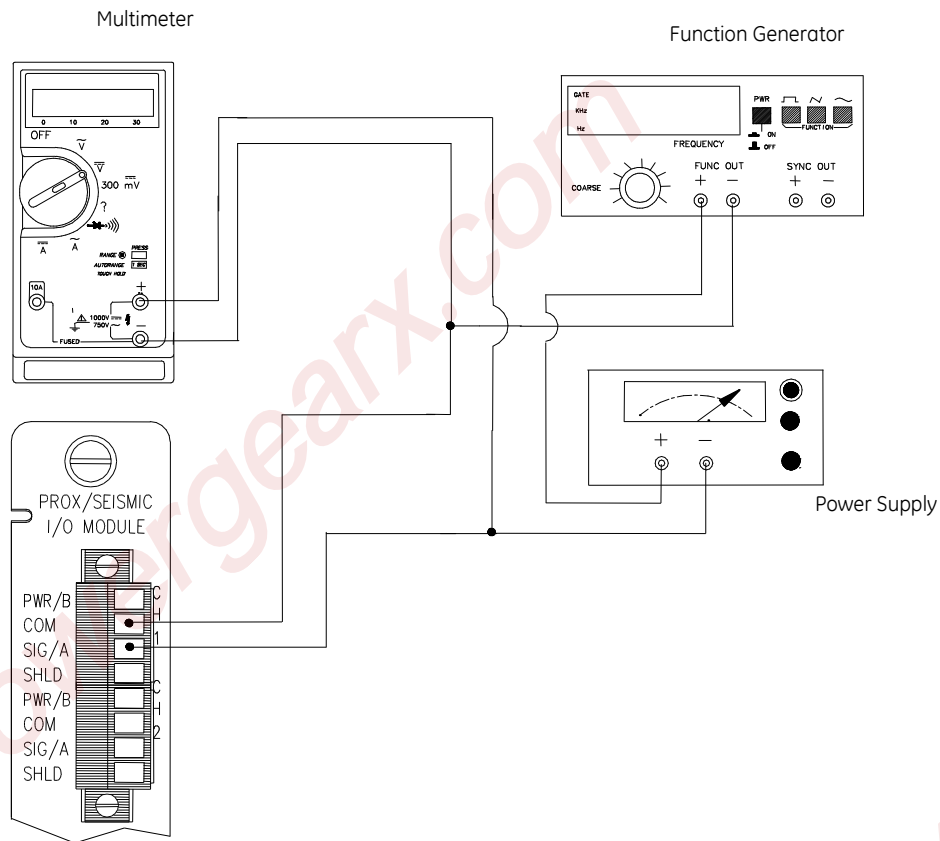

Acceleration Test Setup

The Test Equipment outputs should be floating relative to earth ground.

Verification Screen Setup - Acceleration

Run the Rack Configuration Software on the test computer. Choose **Verification** from the Utilities menu and choose the proper Slot number and Channel number then click on the **Verify** button.

Note

If the Timed OK Channel Defeat is enabled, it will take 30 seconds for a channel to return to the **OK** status from **not OK**. If OK MODE is configured for latching, press the RESET button on the Rack Interface Module (RIM) to return to the **OK** status.

The following table directs you to the starting page of each maintenance section associated with the Acceleration Channels.

Section Number	Topic	Page Number
5.1.8.2	Test Alarms - Direct	196
5.1.8.3	Verify Channels - Direct	198
5.1.8.4	Verify Filter Corner Frequencies	199
5.1.8.7	Test OK Limits	205

5.1.8.2 Test Alarms - Acceleration

The general approach for testing alarm setpoints is to simulate the Acceleration signal with a function generator and power supply. The alarm levels are tested by varying the output from the test equipment and observing that the correct results are reported in the Verification screen on the test computer. It is only necessary to test those alarm parameters that are configured and being used. The general test procedure to verify current alarm operation will include simulating a transducer input signal and varying this signal:

1. to exceed over Alert/Alarm 1 and Danger/Alarm 2 Setpoints, and
2. to drop below any under Alert/Alarm 1 and Danger/Alarm 2 Setpoints, and
3. to produce a nonalarm condition.

When varying the signal from an alarm condition to a nonalarm condition, alarm hysteresis must be considered. Adjust the signal well below the alarm setpoint for the alarm to clear.

Direct

1. Disconnect PWR / B, COM, and SIG / A field wiring from the channel terminals on the I/O module.
2. Connect test equipment and run software as described in Section 5.1.8.1 (Test Equipment and Software Setup - Acceleration). If no filtering has been configured, leave the frequency of the function generator set to 100 Hz. If filtering is configured, the needed frequency can be calculated from the following formula:

$$\text{Frequency} = (0.89 \times \text{HPF}) + (0.1575 \times \text{LPF})$$

HPF = High-pass Filter Corner Frequency

LPF = Low-pass Filter Corner Frequency

If no filtering is configured, set the frequency of the function generator to 100 Hz.

If a low-pass filter is configured and no high-pass filter is configured, use the following to determine the HPF to use in the formula:

- If the units are integrated or rms, use a HPF of 10 Hz. For any other configuration, use a HPF of 3 Hz.

If a high-pass filter is configured and no low-pass filter is configured, use the following to determine the LPF to use in the formula:

- If the configuration is a single channel with **no** integration, use a LPF of 30 kHz.
- If the configuration is a single channel **with** integration, use a LPF of 14.5 kHz.
- If the configuration is a dual channel pair, use a LPF of 9.155 kHz.

Set the frequency of the function generator to this new value. The above is done to obtain a test frequency in the center of the channel frequency range.

3. Adjust the function generator amplitude to produce a reading that is below the Direct setpoint levels on the Direct bar graph display of the Verification screen.
4. Press the RESET switch on the Rack Interface Module (RIM). Verify that the OK LED is on, the bar graph indicator for Direct is green, and the Current Value field contains no alarm indication.
5. Adjust the function generator amplitude such that the signal just exceeds the Direct Over Alert/Alarm 1 setpoint level. Wait for 2 or 3 seconds after the alarm time delay expires and verify that the bar graph indicator for Direct changes color from green to yellow and the Current Value Field indicates an Alarm.

6. Press the RESET switch on the Rack Interface Module (RIM). Verify that the bar graph indicator for Direct remains yellow and that the Current Value Field still indicates an Alarm.
7. Adjust the function generator amplitude such that the signal just exceeds the Direct Over Danger/Alarm 2 setpoint level. Wait for 2 or 3 seconds after the alarm time delay expires and verify that the bar graph indicator for Direct changes color from yellow to red and that the Current Value Field indicates an Alarm.
8. Press the RESET switch on the Rack Interface Module (RIM). Verify that the bar graph indicator for Direct remains red and that the Current Value Field still indicates an Alarm.
9. Adjust the function generator amplitude such that the signal reads below the Over Alarm setpoint levels. If the nonlatching option is configured, observe that the bar graph indicator for Direct changes color to green. The Current Value Box should contain no indication of Alarms. Press the RESET switch on the Rack Interface Module (RIM) to reset latching alarms.
10. If you can not verify any configured alarm, recheck the configured setpoints. If the monitor still does not alarm properly or fails any other part of this test, go to Section 5.1.10 (If a Channel Fails a Verification Test).
11. Disconnect the test equipment and reconnect the PWR / B, COM, and SIG / A field wiring to the channel terminals on the I/O module. Verify that the OK LED comes on and the OK relay energizes. Press the RESET switch on the Rack Interface Module (RIM) to reset the OK LED.
12. Repeat steps 1 through 11 for all configured channels.

5.1.8.3 Verify Channel Values - Acceleration

The general approach for testing these parameters is to simulate the Acceleration signal with a function generator and power supply. The channel values are verified by varying the output from the test equipment and observing that the correct results are reported in the Verification screen on the test computer.

<p style="text-align: center;">Note</p>
--

<p>These parameters have an accuracy specification of ± 1 % of full scale.</p>

Direct

1. Disconnect PWR / B, COM, and SIG / A field wiring from the channel terminals on the I/O module.
2. Connect test equipment and run software as described in section 5.1.8.1 (Test Equipment and Software Setup - Acceleration).
3. Calculate the verification frequency using the method in Section 5.1.8.5, page 201. Adjust the function generator frequency to the calculated value.
4. Calculate the full-scale voltage using the formulas in Section 5.1.8.6, page 201. Adjust the function generator (sinewave) amplitude to the calculated value.
5. Verify that the Direct bar graph display and the Current Value Box is reading ± 1 % of full scale. If the recorder output is configured, refer to Section 5.1.9 (Verify Recorder Outputs) for steps to verify the recorder output.
6. If the reading does not meet specifications, check that the input signal is correct. If the monitor still does not meet specifications or fails any other part of this test, go to Section 5.1.10 (If a Channel Fails a Verification Test).
7. Disconnect the test equipment and reconnect the PWR / B, COM, and SIG / A field wiring to the channel terminals on the I/O module. Verify that the OK LED comes on and the OK relay energizes. Press the RESET switch on the Rack Interface Module (RIM) to reset the OK LED.
8. Repeat steps 1 through 7 for all configured channels.

5.1.8.4 Verify Filter Corner Frequencies

The general approach for testing these parameters is to simulate the Acceleration signal with a function generator and power supply. The corner frequencies are verified by varying the output from the test equipment and observing that the correct results are reported in the Verification screen on the test computer.

Note

If the channel units are integrated, change the channel configuration to a non-integrated scale for this test. When the test is complete, return the channel to its original configuration.

1. Disconnect PWR / B, COM, and SIG / A field wiring from the channel terminals on the I/O module.

2. Connect test equipment and run software as described in Section 5.1.8.1 (Test Equipment and Software Setup - Acceleration).
3. Calculate the verification frequency using the method in Section 5.1.8.5, page 201. Adjust the function generator frequency to the calculated value.
4. Calculate the full-scale voltage using the formulas in Section 5.1.8.6, page 201. Adjust the function generator (sinewave) amplitude to the calculated.
5. Verify that the Direct bar graph display and the Current Value Box is reading full scale.
6. Adjust the function generator frequency to the Low-pass Filter Corner Frequency. Verify that the Direct bar graph display and the Current Value Box is reading between 65 % and 75 % of full scale.
7. Adjust the function generator frequency to the High-pass Filter Corner Frequency. Verify that the Direct bar graph display and Current Value Box is reading between 65 % and 75 % of full scale.
8. If the reading does not meet specifications, check that the input signal is correct. If the monitor still does not meet specifications or fails any other part of this test, go to Section 5.1.10 (If a Channel Fails a Verification Test).
9. Disconnect the test equipment and reconnect the PWR / B, COM, and SIG / A field wiring to the channel terminals on the I/O module. Verify that the OK LED comes on and the OK relay energizes. Press the RESET switch on the Rack Interface Module (RIM) to reset the OK LED.
10. Repeat steps 1 through 9 for all configured channels.

5.1.8.5 Calculating Verification Frequency

The procedures for verifying channel values and corner frequencies require that you use the following formulas to calculate the verification frequency.

Find the center of the Band-pass frequency range. Input the configured high-pass filter corner frequency and the low-pass filter corner frequency into the formula below:

$$\text{Frequency} = (0.89 \times \text{HPF}) + (0.1575 \times \text{LPF})$$

HPF = High-pass Filter Corner Frequency

LPF = Low-pass Filter Corner Frequency

If no filtering is configured, set the frequency of the function generator to 100 Hz.

If a low-pass filter is configured and no high-pass filter is configured, use the following to determine the HPF to use in the formula:

- If the units are integrated or rms, use a HPF of 10 Hz. For any other configuration, use a HPF of 3 Hz.

If a high-pass filter is configured and no low-pass filter is configured, use the following to determine the LPF to use in the formula:

- If the configuration is a single channel with **no** integration, use a LPF of 30 kHz.
- If the configuration is a single channel **with** integration, use a LPF of 14.5 kHz.
- If the configuration is a dual channel pair, use a LPF of 9.155 kHz.

5.1.8.6 Calculating the Input Voltage for Full-scale

The procedures for verifying channel values and corner frequencies required that you use the following formulas to calculate the input voltage for full-scale. To find the full-scale input voltage, use appropriate table for integrated or non-integrated units.

Note

Use the transducer scale factor displayed in the Scale Factor Box on the Verification screen.

Full Scale Formulas - No Integration

Units	To Input RMS Volts	To Input Peak to Peak Volts
g peak	$(T.S.F. \times \text{Full-scale}) \times 0.707$	$(T.S.F. \times \text{Full-scale}) \times 2$
g rms	$(T.S.F. \times \text{Full-scale})$	$(T.S.F. \times \text{Full-scale}) \times 2.82$
m/s ² peak	$(T.S.F. \times \text{Full-scale}) \times 0.707$	$(T.S.F. \times \text{Full-scale}) \times 2$
m/s ² rms	$(T.S.F. \times \text{Full-scale})$	$(T.S.F. \times \text{Full-scale}) \times 2.82$

T.S.F = Transducer Scale Factor. To use the formulas, the T.S.F. should be in volts and the T.S.F. and full-scale values should both be of the same unit system (metric or English). The transducer Scale Factor will always be specified as volts per g pk or volts per m/s² pk.

Example 1:

Transducer Scale Factor = 100 mV/g

Full Scale = 2 g peak

For Peak to Peak input:

$$(0.100 \times 2) \times 2 = 0.4 \text{ Vpp}$$

For Vrms input:

$$(0.100 \times 2) \times 0.707 = 0.1414 \text{ Vrms}$$

Example 2:

Transducer Scale Factor = 10.19 mV/(m/s²)

Full Scale = 20 m/s² pk

For Peak to Peak input:

$$(0.01019 \times 20) \times 2 = 0.4076 \text{ Vpp}$$

For RMS input:

$$(0.01019 \times 20) \times 0.707 = 0.1440 \text{ Vrms}$$

Full Scale Formulas - Integration

(For the Following units: in/s pk, in/s rms, mm/s pk, mm/s rms)

To input rms volts for peak full scale units:

$$\text{Input Voltage (V rms)} = \left[\frac{\text{Full - scale (English units)}}{\left(\frac{30.72}{\text{Scale Factor (English units)}} \right) / \text{Velocity Frequency}} \right] \times 0.3535$$

(0.1 volts / g typical)

$$\text{Input Voltage (V rms)} = \left[\frac{\text{Full - scale (English units)}}{\left(\frac{30.72}{\text{Scale Factor (English units)}} \right) / \text{Velocity Frequency}} \right] \times 0.5$$

(0.1 volts / g typical)

To input rms volts for rms full scale units:

$$\text{Input Voltage (V pp)} = \left[\frac{\text{Full - scale (English units)}}{\left(\frac{30.72}{\text{Scale Factor (English units)}} \right) / \text{Velocity Frequency}} \right] \times 1.414$$

(0.1 volts / g typical)

To input peak to peak volts for peak full scale units:

To input peak to

peak volts for RMS full scale units:

To use the formulas, the acceleration scale factor should be in volts, and the full-scale value and acceleration scale factor should be in English units. Use the following conversion formulas to convert metric units to English units:

$$\frac{\text{Acceleration Scale Factor}}{(mV / g)} = \frac{\text{Acceleration Scale Factor}}{(mV / (m / s^2))} \times 9.8135$$

$$\frac{\text{Full - Scale}}{(inch / s)} = \frac{\text{Full - Scale}}{(mm / s)} \times 0.39372$$

Scale Factor:

Full-scale:

Example:

Transducer Scale Factor = 10.19 mV/(m/s²)

Full Scale = 25 mm/s

HPF = 10 Hz

LPF = 8000 Hz

1. Convert metric units to English units.

Scale Factor:

$$10.19 \text{ mV}/(m/s^2) \times 9.8135 = 100 \text{ mV}/g$$

Full-scale:

$$25 \text{ mm}/s \times 0.039372 = 1 \text{ in}/s$$

2. Calculate the input voltage.

To Input RMS Volts for Peak Units

$$\begin{aligned} \text{Input Voltage (V rms)} &= \left[\frac{1}{\left(\frac{30.72}{0.1} \right) / 282.84} \right] \times 0.3535 = 0.3254 \text{ V rms} \\ \text{Input Voltage (V pp)} &= \left[\frac{1}{\left(\frac{30.72}{0.1} \right) / 282.84} \right] \times 1 = 0.9207 \text{ V pp} \end{aligned}$$

To Input Peak to Peak Volts for Peak Units

5.1.8.7 Test OK Limits – Acceleration

Note

If the Danger Bypass has been activated, then the BYPASS LED will be on. All other channels in the rack must be OK or bypassed for the OK relay to be energized.

The general approach for testing OK limits is to input a DC voltage and adjust it above the Upper OK limit and below the Lower OK limit. This should cause a not OK condition and cause the OK Relay to change state. The Upper and Lower OK limits are displayed in the Verification screen on the test computer.

1. Disconnect PWR, COM, and SIG field wiring from the channel terminals on the I/O module.
2. Connect test equipment and run software as described in Section 5.1.8.1 (Test Equipment and Software Setup - Acceleration).
3. Bypass all other configured channels.
4. Adjust the power supply voltage to -7.00 Vdc.
5. Press the RESET switch on the Rack Interface Module (RIM). Verify that the monitor OK LED is on and that the Channel OK State line in the Channel Status section of the Verification Display screen reads **OK**.
6. Verify that the OK relay on the Rack Interface I/O Module indicates OK (energized). See 3500/20 Rack Interface Module manual, part #129768-01.
7. Increase the power supply voltage (more negative) until the OK LED just goes off (upper limit). Verify that the Channel OK State line on the Verification screen reads **not OK** and that the OK Relay indicates not OK. Verify that the Upper OK limit voltage displayed on the Verification screen

is equal to or more positive than the input voltage.

8. Decrease the power supply voltage (less negative) to -7.00 Vdc.
9. Press the RESET switch on the Rack Interface Module (RIM). Verify that the OK LED comes back on and the OK relay energizes. Verify that the Channel OK State line in the Channel Status section reads **OK**.
10. Gradually decrease the power supply voltage (less negative) until the OK LED just goes off (lower limit). Verify that the Channel OK State line in the Channel Status section reads **not OK** and that the OK Relay indicates not OK. Verify that the Lower OK limit voltage displayed on the Verification screen is equal to or more negative than the input voltage.
11. Increase the power supply voltage (more negative) to -7.00 Vdc.
12. Press the RESET switch on the Rack Interface Module (RIM). Verify that the OK LED comes back on, the OK relay energizes, and the Channel OK State line in the Channel Status section reads **OK**.
13. If you can't verify any configured OK limit, go to Section 5.1.10 (If a Channel Fails a Verification Test).
14. Disconnect the power supply and multimeter and reconnect the PWR, COM, and SIG field wiring to the channel terminals on the Proximitors/Seismic I/O Module. Press the RESET switch on the Rack Interface Module (RIM) and verify that the OK LED comes on and the OK relay energizes.
15. Repeat steps 1 through 14 for all configured channels.
16. Return the bypass switch for all configured channels back to their original setting.

Acceleration Default OK Limits Table

Transducer	Lower Ok Limit (Volts)	Upper Ok Limit (Volts)
23733-03 w/o barriers	-2.7 to -2.8	-15.0 to -15.1
23733-03 w/ barriers	-3.05 to -3.15 -2.7 to -2.8 *	-13.8 to -13.9 -15.0 to -15.1 *
49578-01 w/o barriers	-5.58 to -5.68	-11.32 to -11.42
49578-01 w/ barriers	-5.29 to -5.39 -5.58 to -5.68 *	-10.81 to -10.91 -11.32 to -11.42 *
24145-02 w/o barriers	-2.7 to -2.8	-15.0 to -15.1
155023-01 w/o barriers	-5.58 to -5.68	-11.32 to -11.42
330400 w/ barriers	-3.05 to -3.15 -2.7 to -2.8 *	-13.8 to -13.9 -15.0 to -15.1 *
330400 w/o barriers	-2.7 to -2.8	-15.0 to -15.10
330425 w/ barriers	-5.29 to -5.39 -5.58 to -5.68 *	-10.81 to -10.91 -11.32 to -11.42 *
330425 w/o barriers	-5.58 to -5.68	-11.32 to -11.42

Note: Assume ± 50 mV accuracy for check tolerance.
* = BNC Internal Barrier I/O Modules.

5.1.9 Verify Recorder Outputs

The following test equipment and procedure should be used in the verification of the recorder outputs. Recorder outputs for the 3500/42 Proximito/Seismic Monitor Module are 4 to 20 mA.

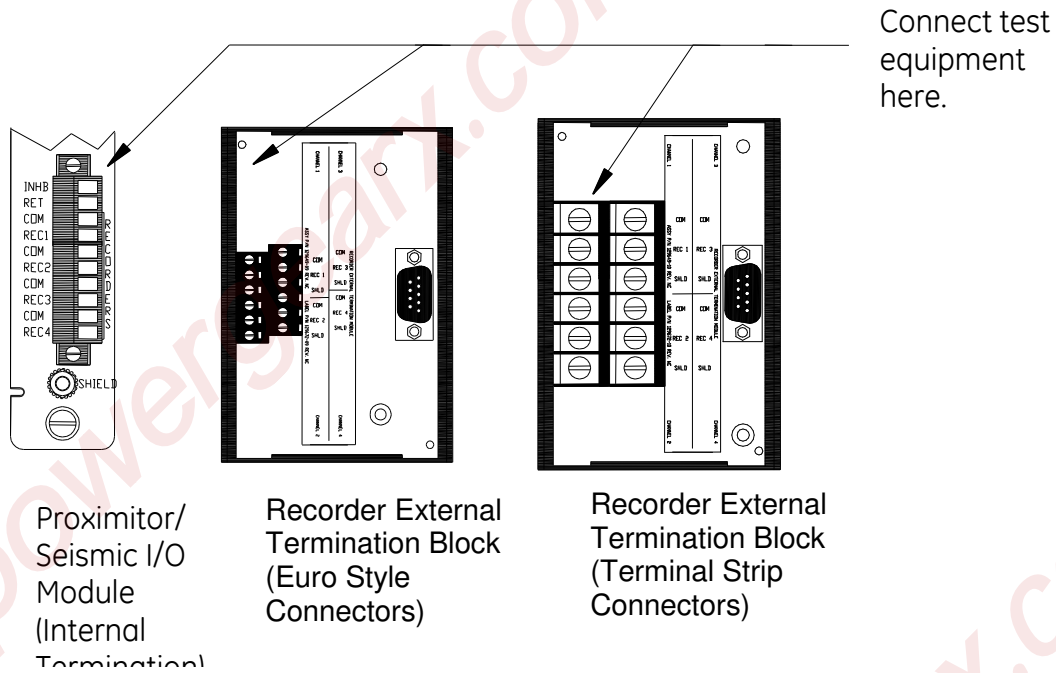

1. Disconnect the COM and REC field wiring from the channel terminals on the I/O module.
2. Connect a multimeter to the COM and REC outputs of the I/O module. The multimeter should have the capability to measure 4 to 20 mA.
3. **If the proportional value is not Gap:**
Set the proportional value that the recorder is configured for to full-scale (Refer to the proportional value of the channel pair type you are testing in the Verify Channel Values portion of this manual). Verify that the recorder output is reading 20 mA \pm 1 %. Go to step 4.

If the proportional value is Gap:

Set the Gap proportional value to -18.00 Vdc (Refer to the proportional value of the channel pair type you are testing in the Verify Channel Values portion of this manual). Verify that the recorder output is reading 16 mA

±1 %.

4. Set the proportional value that the recorder is configured for to mid-scale. Verify that the recorder output is reading 12 mA ±1 %.
5. Set the proportional value that the recorder is configured for to bottom-scale. Verify that the recorder output is reading 4 mA ±1 %.
6. Disconnect transducer input and verify that the recorder output matches the set monitor clamp value ±1 %.
7. If you can not verify the recorder output, the recorder configuration and connections should be checked. If the monitor recorder output still does not verify properly, go to Section 5.1.10 (If a Channel Fails a Verification Test).
8. Disconnect the multimeter and reconnect the COM and REC field wiring to the channel terminals on the I/O module.
9. Repeat steps 1 through 8 for all configured recorder channels.

5.1.10 If a Channel Fails a Verification Test

When handling or replacing circuit boards, always be sure to adequately protect against damage from Electrostatic Discharge (ESD). Always wear a proper wrist strap and work on a grounded conductive work surface.

1. Save the configuration for the module using the Rack Configuration Software.
2. Replace the module with a spare. Refer to the installation section in the 3500 Monitoring System Rack Installation and Maintenance Manual (part number 129766-01).
3. Return the faulty board to Bently Nevada Corporation for repair.
4. Download the configuration for the spare module using the Rack Configuration Software.
5. Verify the operation of the spare.

5.2 Adjusting the Scale Factor and the Zero Position

This section shows how to adjust the transducer scale factor and the transducer position, or "zero". The Scale Factor Adjustment can be used to accommodate any deviations in transducer scale factor as measured on the installed transducers. Do not use the procedure to compensate for any errors within the monitor and the I/O module. If a monitor does not meet specifications, exchange it with a spare and return the faulty module to Bently Nevada Corporation for repair. The newly installed spare module should be properly configured and tested.

Adjusting the scale factor affects the readings of all configured parameters associated with the channel. If you change the scale factor, be sure to use the new value when calculating inputs for verification of channel values.

The Zero Position Adjustment is used for Thrust, Eccentricity, and Differential Expansion measurements as well as for Gap measurements when Gap is configured to read in displacement units (not volts). Adjust the zero position after the probe is gapped and its target is in the proper position.

Both adjustment procedures consist of using the Rack Configuration Software to upload the configuration from the rack, change the setting for scale factor or zero position, and then downloading the new configuration back to the rack. You can adjust these settings using the following two methods:

enter a new value in the scale factor box on the transducer screen or the zero position box on the Channel Options screen.

use **Adjust** to get immediate feedback from the channel on the Adjust screen.

The advantage of using the Adjust screen is that you can use the bar graphs to see the effect of your adjustments on the output signals of the channel. The following procedures show how to use the methods.

5.2.1 Adjusting the Scale Factor

1. Connect the configuring computer to the rack using one of the methods listed in the 3500 Monitoring System Rack Configuration and Utilities Guide (part number 129777-01).
2. Run the Rack Configuration Software.

3. Initiate communication with the rack by clicking on the **C**onnect option in the File menu and then selecting the connection method that you used in step 1.
4. Upload the configuration from the rack by clicking on the **U**pload option in the File menu.
5. Click on the **Options** button on the 3500 System Configuration screen.
6. Select the monitor you want to adjust. The Monitor screen will appear.
7. Select the **O**ptions button under the appropriate Channel. The configured Channel Options screen will appear.
8. Select the **C**ustomize button in the Transducer Selection box. A Transducer screen will appear.
9. Enter a value for scale factor in the Scale Factor box. If you go to the Adjust screen by selecting **A**adjust, be sure to adjust the input to the channel away from the Zero Position so you can adjust the scale factor and see the results.
10. Return to the 3500 System Configuration screen by clicking on the **O**K buttons of the successive screens. The new scale factor is now added to the configuration for this channel.
11. Download the new configuration to the appropriate monitor by selecting **D**ownload from the File menu. The new setting for scale factor will take effect when the "Download successful" prompt appears.

5.2.2 Zero Position Adjustment Description

When adjusting the Zero Position voltage, you are defining the transducer voltage corresponding to the position of the zero indication on a bar graph display (refer to the adjacent figure).

For maximum amount of zero adjustment, gap the transducer as close as possible to the ideal zero position voltage based on the full-scale range and transducer scale factor. For a mid-scale zero, as in the example, the ideal gap is the center of the range. The tables below specify the center of the range for each transducer and monitor type.

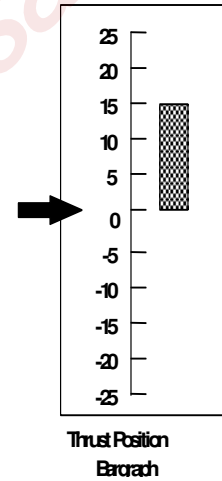

Radial Vibration Ok Limits and Center Gap Voltage

Transducer	Upper Ok Limits		Lower Ok Limits		Center Gap Voltage	
	w/o barrier (v)	w/ barrier (v)	w/o barrier(v)	w/ barrier (v)	w/o barrier (v)	w/ barrier (v)
3300 5mm	-16.75	-16.75	-2.75	-2.75	-9.75	-9.75
3300 8mm	-16.75	-16.75	-2.75	-2.75	-9.75	-9.75
7200 5mm	-16.75	-16.75	-2.75	-2.75	-9.75	-9.75
7200 8mm	-16.75	-16.75	-2.75	-2.75	-9.75	-9.75
7200 11mm	-19.65	n/a	-3.55	n/a	-11.6	n/a
7200 14mm	-16.75	n/a	-2.75	n/a	-9.75	n/a
3000 (18V)	-12.05	n/a	-2.45	n/a	-7.25	n/a
3000 (24V)	-15.75	n/a	-3.25	n/a	-9.5	n/a
3300 RAM	-12.55	-12.15	-2.45	-2.45	-7.5	-7.3
3300 16mm HTPS	-16.75	n/a	-2.75	n/a	-9.75	n/a

Note: With Barriers includes BNC Internal Barrier I/O Modules.

Thrust Position Ok Limits and Center Gap Voltage

Transducer	Upper Ok Limits		Lower Ok Limits		Center Gap Voltage	
	w/o barrier (V)	w/ barrier (V)	w/o barrier (V)	w/ barrier (V)	w/o barrier (V)	w/ barrier (V)
3300 5mm	-19.04	-18.2	-1.28	-1.1 -1.28*	-10.16	-9.65 -9.74*
3300 8mm	-19.04	-18.2	-1.28	-1.1 -1.28*	-10.16	-9.65 -9.74*
7200 5mm	-19.04	-18.2	-1.28	-1.1 -1.28*	-10.16	-9.65 -9.74*
7200 8mm	-19.04	-18.2	-1.28	-1.1 -1.28*	-10.16	-9.65 -9.74*
7200 11mm	-20.39	n/a	-3.55	n/a	-11.97	n/a
7200 14mm	-18.05	n/a	-1.65	N/a	-9.85	n/a
3000 (-18V)	-13.14	n/a	-1.16	n/a	-7.15	n/a
3000 (-24V)	-16.85	n/a	-2.25	n/a	-9.55	n/a
3300 RAM	-13.14	-12.35	-1.16	-1.05 -1.16*	-7.15	-6.7 -6.76*
3300 16mm HTPS	-18.05	n/a	-1.65	n/a	-9.85	n/a

* BNC Internal Barrier I/O Modules.

Differential Expansion Ok Limits and Center Gap Voltage

Transducer	Upper Ok Limits	Lower Ok Limits	Center Gap Voltage
25 mm	-12.55	-1.35	-6.95
35 mm	-12.55	-1.35	-6.95
50 mm	-12.55	-1.35	-6.95

Eccentricity Ok Limits and Center Gap Voltage

Transducer	Upper Ok Limits		Lower Ok Limits		Center Gap Voltage	
	w/o barrier (V)	w/ barrier (V)	w/o barrier (V)	w/ barrier (V)	w/o barrier (V)	w/ barrier (V)
3300 5mm	-16.75	-16.75	-2.75	-2.75	-9.75	-9.75
3300 8mm	-16.75	-16.75	-2.75	-2.75	-9.75	-9.75
7200 5mm	-16.75	-16.75	-2.75	-2.75	-9.75	-9.75
7200 8mm	-16.75	-16.75	-2.75	-2.75	-9.75	-9.75
7200 11mm	-19.65	n/a	-3.55	n/a	-11.6	n/a
7200 14mm	-16.75	n/a	-2.75	n/a	-9.75	n/a
3300 16mm HTPS	-16.75	n/a	-2.75	n/a	-9.75	n/a

Note: With Barriers includes BNC Internal Barrier I/O Modules.

Acceleration Ok Limits and Center Gap Voltage

Transducer	Upper Ok Limits		Lower Ok Limits		Center Gap Voltage	
	w/o barrier (V)	w/ barrier (V)	w/o barrier (V)	w/ barrier (V)	w/o barrier (V)	w/ barrier (V)
23733-03	-15.05	-13.85 -15.05*	-2.75	-3.10 -2.75*	-8.90	-8.475 -8.90*
24145-02	-15.05	n/a	-2.75	n/a	-8.90	n/a
330400	-15.05	-13.85 -15.05*	-2.75	-3.10 -2.75*	-8.90	-8.475 -8.90*
330425	-11.37	-10.86 -11.37*	-5.63	-5.34 -5.63*	-8.50	-8.10 -8.50*
49578-01	-11.37	-10.86 -11.37*	-5.63	-5.34 -5.63*	-8.50	-8.10 -8.50*
155023-01	-11.37	n/a	-5.63	n/a	-8.50	n/a

* BNC Internal Barrier I/O Modules.

Velocity Ok Limits and Center Gap Voltage

Transducer	Upper Ok Limits		Lower Ok Limits		Center Gap Voltage	
	w/o barrier (V)	w/ barrier (V)	w/o barrier (V)	w/ barrier (V)	w/o barrier (V)	w/ barrier (V)
9200	-17.95	-17.95	-2.05	-2.05	-10.00	-10.00
47633	-17.95	-17.95	-2.05	-2.05	-10.00	-10.00
86205	-17.95	-17.95	-2.05	-2.05	-10.00	-10.00
Non Standard	-17.95	-17.95	-2.05	-2.05	-10.00	-10.00
Velomitor	-19.85	-17.95 -19.85*	-4.15	-2.05 -4.15*	-12.00	-10.00 -12.00*
High Temp Velomitor	-21.26	-21.26	-2.74	-2.74	-12.00	-12.00

* BNC Internal Barrier I/O Modules.

When increasing or decreasing the zero position voltage, you are actually mapping the monitor full scale range to a portion of the transducer linear range. The zero position voltage adjustment range is dependent upon the full-scale range of the proportional value being adjusted, the transducer scale factor, and the transducer Ok limits. The following example shows how these parameters are related to the zero position voltage range.

Channel Pair Type:	Thrust Position
Direct Full Scale Range:	-40-0-40 mils
Transducer Type:	3300 8mm
Scale Factor:	200 mV/mil
Ok Limits:	-19.04 (upper) -1.28 (lower)

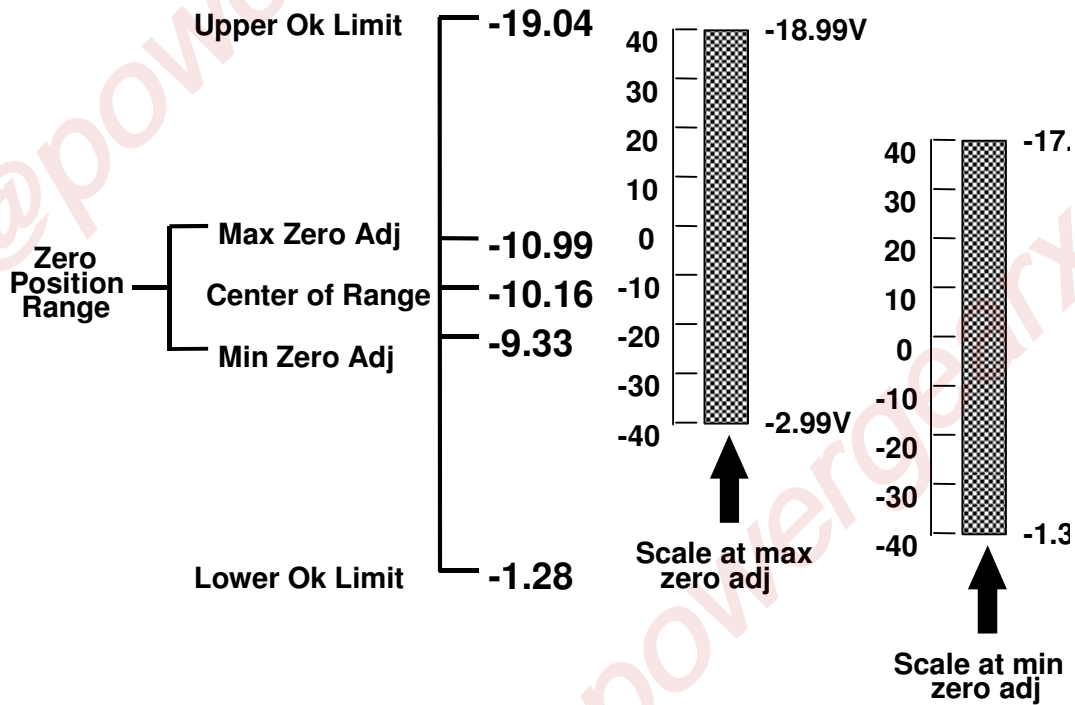

5.2.3 Adjusting the Zero Position

1. Connect the configuring computer to the rack using one of the methods listed in the 3500 Monitoring System Rack Configuration and Utilities Guide (part number 129777-01).

2. Run the Rack Configuration Software.
3. Initiate communication with the rack by clicking on the **C**onnect option in the File menu and then selecting the connection method that you used in step 1.
4. Upload the configuration from the rack by clicking on the **U**pload option in the File menu.
5. Select the **O**ptions button on the 3500 System Configuration screen.
6. Select the monitor you want to adjust. The Monitor screen will appear.
7. Select the **O**ptions button under the appropriate Channel. The Channel Options screen will appear.
8. Enter the voltage in the Zero Position or the Gap Position box. Changes are limited to the values listed adjacent to the box. If you go to the Adjust screen by selecting **A**adjust, you can adjust the Zero Position and see the results.
9. Return to the 3500 System Configuration screen by clicking on **O**K buttons in the successive screens. The new Zero Position or Gap Position is now added to the configuration for this channel.
10. Download the new configuration to the appropriate monitor by selecting the **D**ownload option in the File menu and then selecting the appropriate monitor. The new setting for Zero Position will take effect when the "Download successful" prompt appears.

6. Troubleshooting

This section describes how to troubleshoot a problem with the Proximator®/Seismic Monitor or the I/O module by using the information provided by the self-test, the LED's, the System Event List, and the Alarm Event List.

6.1 Self-test

To perform the Proximator/Seismic Monitor self-test:

1. Connect a computer running the Rack Configuration Software to the 3500 rack (if needed).
2. Select **Utilities** from the main screen of the Rack Configuration Software.
3. Select **System Events/Module Self-test** from the Utilities menu.
4. Press the **Module Self-test** button on the System Events screen.

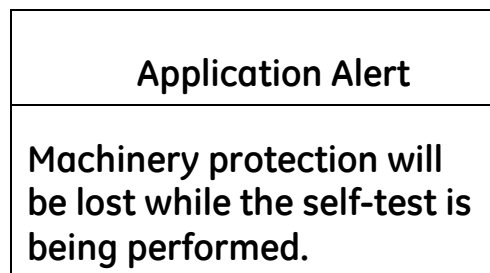

5. Select the slot that contains the Proximator/Seismic Monitor and press the **OK** button. The Proximator/Seismic Monitor will perform a full self-test and the System Events screen will be displayed. The list will not contain the results of the self-test.
6. Wait 30 seconds for the module to run a full self-test.
7. Press the **Latest Events** button. The System Events screen will be updated to include the results of the Proximator/Seismic Monitor self-test.
8. Verify if the Proximator/Seismic Monitor passed the self-test. If the monitor failed the self-test, refer to Section 6.3 (System Event List Messages).

6.2 LED Fault Conditions

The following table shows how to use the LED's to diagnose and correct problems.

OK Led	TX/RX	BYPASS	Condition	Solution
1 Hz	1 Hz		Monitor is not configured, is in Configuration Mode, or in Calibration Mode.	Reconfigure the Monitor, or exit Configuration, or Calibration Mode.
5 Hz			Monitor error	Check the System Event List for severity.
ON	Flashing		Module is operating correctly	No action required.
OFF			Monitor is not operating correctly or the transducer has faulted and has stopped providing a valid signal.	Check the System Event List and the Alarm Event List.
2 Hz			Monitor is configured for Timed OK Channel Defeat and has been not OK since the last time the RESET button was pressed.	Press the Reset button on the Rack Interface Module. Check the System Event List.
	Not flashing		Monitor is not operating correctly.	Monitor is not executing alarming functions. Replace immediately.
		OFF	Alarm Enabled	No action required.
		ON	Some or all Alarming Disabled	No action required.
 Behavior of the LED is not related to the condition.				

6.3 System Event List Messages

This section describes the System Event List Messages that are entered by the Proximator/Seismic Monitor and gives an example of one.

Example of a System Event List Message:

Sequence Number	Event Information	Event Number	Class	Event Date DDMMYY	Event Time	Event Specific	Slot
00000001 23	Device Not Communicating	32	1	02/01/90	12:24:31:99		5L

Sequence Number: The number of the event in the System Event List (for example 123).

Event Information: The name of the event (for example Device Not Communicating).

Event Number: Identifies a specific event.

Class: Used to display the severity of the event. The following classes are available:

Class Value	Classification
0	Severe/Fatal Event
1	Potential Problem Event
2	Typical logged Event
3	Reserved

Event Date: The date the event occurred.

Event Time: The time the event occurred.

Event Specific: It provides additional information for the events that use this field.

Slot: Identifies the module that the event is associated with. If a half-height module is installed in the upper slot or a full-height module is installed, the field will be 0 to 15. If a half-height module is installed in the lower slot, then the field will be 0L to 15L. For example, a module installed in the lower position in slot 5 would be 5L.

The following System Event List Messages may be placed in the list by the Proximitor/Seismic Monitor and are listed in numerical order. If an event marked with a star (*) occurs the Proximitor/Seismic Monitor will stop alarming. If you are unable to solve any problems contact your nearest Bently Nevada Corporation office.

Flash Memory Failure

Event Number: 11

Event Classification: Severe / Fatal Event

Action: Replace the Monitor Module as soon as possible.

EEPROM Memory Failure

Event Number: 13

Event Classification: Potential Problem or Severe / Fatal Event

Action: Replace the Monitor Module as soon as possible.

Device Not Communicating

Event Number: 32

Event Classification: Potential Problem

Action: Check to see if one of the following components is faulty:

- the Monitor Module
- the rack backplane

Device Is Communicating

Event Number: 33

Event Classification: Potential Problem

Action: Check to see if one of the following components is faulty:

- the Monitor Module
- the rack backplane

*** Neuron Failure**

Event Number: 34

Event Classification: Severe / Fatal Event

Action: Replace the Monitor Module immediately.

Monitor Module will stop alarming.

*** I/O Module Mismatch**

Event Number: 62

Event Classification: Severe / Fatal Event

Action: Verify that the type of I/O module installed matches what was selected in the software. If the correct I/O module is installed, there may be a fault with the Monitor Module or the Monitor I/O module.
Monitor Module will stop alarming.

I/O Module Compatible

Event Number: 63

Event Classification: Severe / Fatal Event

Action: Verify that the type of I/O module installed matches what was selected in the software. If the correct I/O module is installed, there may be a fault with the Monitor Module or the Monitor I/O module.

*** Fail I/O Jumper Check**

Event Number: 64

Event Classification: Severe / Fatal Event

Action: Verify that the type of I/O module installed matches what was selected in the software. If the correct I/O module is installed, there may be a fault with the Monitor Module or the Monitor I/O module.
Monitor Module will stop alarming.

Pass I/O Jumper Check

Event Number: 65

Event Classification: Severe / Fatal Event

Action: Verify that the type of I/O module installed matches what was selected in the software. If the correct I/O module is installed, there may be a fault with the Monitor Module or the Monitor I/O module.

Fail Main Board +5V-A (Fail Main Board +5V - upper Power Supply)

Event Number: 100

Event Classification: Potential Problem

Action: Verify that noise from the power source is not causing the problem. If the problem is not caused by noise, check to see if one of the following components is faulty:

- the Monitor Module
- the Power Supply installed in the upper slot

Pass Main Board +5V-A (Pass Main Board +5V - upper Power Supply)

Event Number: 101

Event Classification: Potential Problem

Action: Verify that noise from the power source is not causing the problem.

If the problem is not caused by noise, check to see if one of the following components is faulty:

- the Monitor Module
- the Power Supply installed in the upper slot

Fail Main Board +5V-B (Fail Main Board +5V - lower Power Supply)

Event Number: 102

Event Classification: Potential Problem

Action: Verify that noise from the power source is not causing the problem.

If the problem is not caused by noise, check to see if one of the following components is faulty:

- the Monitor Module
- the Power Supply installed in the lower slot

Pass Main Board +5V-B (Pass Main Board +5V - lower Power Supply)

Event Number: 103

Event Classification: Potential Problem

Action: Verify that noise from the power source is not causing the problem.

If the problem is not caused by noise, check to see if one of the following components is faulty:

- the Monitor Module
- the Power Supply installed in the lower slot

*** Fail Main Board +5V-AB** (Fail Main Board +5V - upper and lower Power Supplies)

Event Number: 104

Event Classification: Severe/Fatal Event

Action: Verify that noise from the power source is not causing the problem.

If the problem is not caused by noise, check to see if one of the following components is faulty:

- the Monitor Module
- the Power Supply installed in the upper slot
- the Power Supply installed in the lower slot

Monitor Module will stop alarming.

Pass Main Board +5V-AB

(Pass Main Board +5V - upper and lower Power Supplies)

Event Number: 105

Event Classification: Severe/Fatal Event

Action: Verify that noise from the power source is not causing the problem. If the problem is not caused by noise, check to see if one of the following components is faulty:

- the Monitor Module
- the Power Supply installed in the upper slot
- the Power Supply installed in the lower slot

Fail Main Board +15V-A

(Fail Main Board +15V - upper Power Supply)

Event Number: 106

Event Classification: Potential Problem

Action: Verify that noise from the power source is not causing the problem. If the problem is not caused by noise, check to see if one of the following components is faulty:

- the Monitor Module
- the Power Supply installed in the upper slot

Pass Main Board +15V-A

(Pass Main Board +15V - upper Power Supply)

Event Number: 107

Event Classification: Potential Problem

Action: Verify that noise from the power source is not causing the problem. If the problem is not caused by noise, check to see if one of the following components is faulty:

- the Monitor Module
- the Power Supply installed in the upper slot

Fail Main Board +15V-B

(Fail Main Board +15V - lower Power Supply)

Event Number: 108

Event Classification: Potential Problem

Action: Verify that noise from the power source is not causing the problem. If the problem is not caused by noise, check to see if one of the following components is faulty:

- the Monitor Module
- the Power Supply installed in the lower slot

Pass Main Board +15V-B

(Pass Main Board +15V - lower Power Supply)

Event Number: 109

Event Classification: Potential Problem

Action: Verify that noise from the power source is not causing the problem.

If the problem is not caused by noise, check to see if one of the following components is faulty:

- the Monitor Module
- the Power Supply installed in the lower slot

*** Fail Main Board +15V-AB** (Fail Main Board +15V - upper and lower Power Supplies)

Event Number: 110

Event Classification: Severe/Fatal Event

Action: Verify that noise from the power source is not causing the problem.

If the problem is not caused by noise, check to see if one of the following components is faulty:

- the Monitor Module
- the Power Supply installed in the upper slot
- the Power Supply installed in the lower slot

Monitor Module will stop alarming.

Pass Main Board +15V-AB (Pass Main Board +15V - upper and lower Power Supplies)

Event Number: 111

Event Classification: Severe/Fatal Event

Action: Verify that noise from the power source is not causing the problem.

If the problem is not caused by noise, check to see if one of the following components is faulty:

- the Monitor Module
- the Power Supply installed in the upper slot
- the Power Supply installed in the lower slot

Fail Main Board -24V-A (Fail Main Board -24V - upper Power Supply)

Event Number: 112

Event Classification: Potential Problem

Action: Verify that noise from the power source is not causing the problem.

If the problem is not caused by noise, check to see if one of the following components is faulty:

- the Monitor Module
- the Power Supply installed in the upper slot

Pass Main Board -24V-A (Pass Main Board -24V - upper Power Supply)

Event Number: 113

Event Classification: Potential Problem

Action: Verify that noise from the power source is not causing the problem.
If the problem is not caused by noise, check to see if one of the following components is faulty:

- the Monitor Module
- the Power Supply installed in the upper slot

Fail Main Board -24V-B (Fail Main Board -24V - lower Power Supply)

Event Number: 114

Event Classification: Potential Problem

Action: Verify that noise from the power source is not causing the problem.
If the problem is not caused by noise, check to see if one of the following components is faulty:

- the Monitor Module
- the Power Supply installed in the lower slot

Pass Main Board -24V-B (Pass Main Board -24V - lower Power Supply)

Event Number: 115

Event Classification: Potential Problem

Action: Verify that noise from the power source is not causing the problem.
If the problem is not caused by noise, check to see if one of the following components is faulty:

- the Monitor Module
- the Power Supply installed in the lower slot

*** Fail Main Board -24V-AB** (Fail Main Board -24V - upper and lower Power Supplies)

Event Number: 116

Event Classification: Severe/Fatal Event

Action: Verify that noise from the power source is not causing the problem.
If the problem is not caused by noise, check to see if one of the following components is faulty:

- the Monitor Module
- the Power Supply installed in the upper slot
- the Power Supply installed in the lower slot

Monitor Module will stop alarming.

Pass Main Board -24V-AB

(Pass Main Board -24V - upper and lower Power Supplies)

Event Number: 117

Event Classification: Severe/Fatal Event

Action: Verify that noise from the power source is not causing the problem. If the problem is not caused by noise, check to see if one of the following components is faulty:

- the Monitor Module
- the Power Supply installed in the upper slot
- the Power Supply installed in the lower slot

*** Configuration Failure**

Event Number: 301

Event Classification: Severe/Fatal Event

Action: Download a new configuration to the Monitor Module. If the problem still exists replace the Monitor Module immediately. Monitor Module will stop alarming.

Configuration Failure

Event Number: 301

Event Classification: Potential Problem

Action: Download a new configuration to the Monitor Module. If the problem still exists replace the Monitor Module as soon as possible.

*** Module Entered Cfg Mode**

(Module Entered Configuration Mode)

Event Number: 302

Event Classification: Typical Logged Event

Action: No action required.

Monitor Module will stop alarming.

Software Switches Reset

Event Number: 305

Event Classification: Potential Problem

Action: Download the software switches to the Monitor Module. If the software switches are not correct, replace the Monitor Module as soon as possible.

Internal Cal Reset

(Internal Calibration Reset)

Event Number: 307

Event Classification: Severe/Fatal Event

Event Specific: Ch pair x
Action: Replace Monitor Module immediately.

Monitor TMR PPL Failed (Monitor TMR Proportional value Failed)

Event Number: 310
Event Classification: Potential Problem
Action: Replace the Monitor Module.

Monitor TMR PPL Passed (Monitor TMR Proportional value Passed)

Event Number: 311
Event Classification: Potential Problem
Action: Replace the Monitor Module.

Module Reboot

Event Number: 320
Event Classification: Typical Logged Event
Action: No action required.

*** Module Removed from Rack**

Event Number: 325
Event Classification: Typical Logged Event
Action: No action required.
Monitor Module will stop alarming.

Module Inserted in Rack

Event Number: 326
Event Classification: Typical Logged Event
Action: No action required.

Device Events Lost

Event Number: 355
Event Classification: Typical Logged Event
Action: No action required.

This may be due to the removal of the Rack Interface Module for an extended period of time.

Module Alarms Lost

Event Number: 356
Event Classification: Typical Logged Event

Action: No action required.

This may be due to the removal of the Rack Interface Module for an extended period of time.

*** Module Entered Calibr.** (Module Entered Calibration Mode)

Event Number: 365

Event Classification: Typical Logged Event

Action: No action required.

Monitor Module will stop alarming.

Module Exited Calibr. (Module Exited Calibration Mode)

Event Number: 366

Event Classification: Typical Logged Event

Action: No action required.

Pass Module Self-test

Event Number: 410

Event Classification: Typical Logged Event

Action: No action required.

*** Enabled Ch Bypass** (Enabled Channel Bypass)

Event Number: 416

Event Classification: Typical logged event

Event Specific: Ch x

Action: No action required.

Alarming has been inhibited by this action.

Disabled Ch Bypass (Disabled Channel Bypass)

Event Number: 417

Event Classification: Typical logged event

Event Specific: Ch x

Action: No action required.

*** Enabled Alert Bypass**

Event Number: 420

Event Classification: Typical logged event

Event Specific: Ch x

Action: No action required.

Alarming has been inhibited by this action.

Disabled Alert Bypass

Event Number: 421

Event Classification: Typical logged event

Event Specific: Ch x

Action: No action required.

*** Enabled Danger Bypass**

Event Number: 422

Event Classification: Typical logged event

Event Specific: Ch x

Action: No action required.

Alarming has been inhibited by this action.

Disabled Danger Bypass

Event Number: 423

Event Classification: Typical logged event

Event Specific: Ch x

Action: No action required.

*** Enabled Special Inh** (Enabled Special Inhibit)

Event Number: 424

Event Classification: Typical logged event

Event Specific: Ch x

Action: No action required.

Alarming has been inhibited by this action.

Disabled Special Inh (Disabled Special Inhibit)

Event Number: 425

Event Classification: Typical logged event

Event Specific: Ch x

Action: No action required.

*** Enabled Mon Alarm Byp** (Enabled Monitor Alarm Bypass)

Event Number: 426

Event Classification: Typical logged event

Action: No action required.

Monitor Module will stop alarming.

Disabled Mon Alarm Byp (Disabled Monitor Alarm Bypass)

Event Number: 427

Event Classification: Typical logged event

Action: No action required.

*** Fail Slot Id Test**

Event Number: 461

Event Classification: Severe/Fatal Event

Action: Verify that the Monitor Module is fully inserted in the rack. If the Monitor Module is installed correctly, check to see if one of the following components is faulty:

- the Monitor Module
- the rack backplane

Monitor Module will stop alarming.

Pass Slot Id Test

Event Number: 462

Event Classification: Severe/Fatal Event

Action: Verify that the Monitor Module is fully inserted in the rack. If the Monitor Module is installed correctly, check to see if one of the following components is faulty:

- the Monitor Module
- the rack backplane

*** Enabled Test Signal**

Event Number: 481

Event Classification: Typical logged event

Action: No action required.

Monitor Module will stop alarming.

Disabled Test Signal

Event Number: 482

Event Classification: Typical logged event

Action: No action required.

Switch To Primary Kph

Event Number: 491

Event Classification: Potential Problem

Event Specific: Ch pair x

Action: Check to see if one of the following is faulty:

- the secondary Keyphasor® transducer on the machine
- the Monitor Module

Switch To Backup Kph

Event Number: 492

Event Classification: Potential Problem

Event Specific: Ch pair x

Action: Check to see if one of the following is faulty:

- the primary Keyphasor transducer on the machine
- the Monitor Module

*** Kph Lost**

Event Number: 493

Event Classification: Potential Problem

Event Specific: Ch pair x

Action: Check to see if one of the following is faulty:

- both Keyphasor transducers on the machine
- the Monitor Module
- the Keyphasor Module

For vector and Keyphasor based, alarms the Monitor Module will stop alarming.

DSP Reset Attempted

Event Number: 501

Event Classification: Severe / Fatal Event

Event Specific: Ch pair x

Action: If the message is seen repeatedly in the System Event List, then replace the Monitor Module immediately.

*** DSP Self-test Failure**

Event Number: 502

Event Classification: Severe / Fatal Event

Event Specific: Ch pair x

Action: Replace the Monitor Module immediately.

Monitor Module will stop alarming.

6.4 Alarm Event List Messages

The following Alarm Event List Messages are returned by the Proximito/Seismic Monitor.

Alarm Event List Message	When the message will occur
Entered Alert / Alarm 1	A proportional value in the channel has entered Alert / Alarm 1 and changed the channel Alert / Alarm 1 status
Left Alert / Alarm 1	A proportional value in the channel has left Alert / Alarm 1 and changed the channel Alert / Alarm 1 status
Entered Danger / Alarm 2	A proportional value in the channel has entered Danger / Alarm 2 and changed the channel Danger / Alarm 2 status
Left Danger / Alarm 2	A proportional value in the channel has left Danger / Alarm 2 and changed the channel Danger / Alarm 2 status
Entered not OK	module went not OK
Left not OK	module returned to the OK state

7. Ordering Information

Part number 3500/42 - AXX - BXX

A I/O Module Type

- 01 Discrete I/O Module with Internal Terminations
- 02 Discrete I/O Module with External Terminations *
- 03 TMR I/O Module with External Terminations *
- 04 I/O Module with Internal Barriers (4 x Prox. Channels)
- 05 I/O Module with Internal Barriers (2 x Prox. + 2 x Velomitor Channels)
- 06 I/O Module with Internal Barriers (4 x Velomitor Channels)

* When ordering I/O modules with external terminations, the External Termination Blocks and Cables must be ordered separately for each I/O module.

B Agency Approval Option

- 00 None
- 01 CSA-NRTL/C

Note

If the Monitor is to be used with an Internal Barrier I/O option, then the following software version (or later) is required:

3500 Rack Configuration Software – Version 2.30

Spares

3500/42 Monitor	125672-02
Discrete I/O Module with Internal Terminations*	128229-01
Discrete I/O Module with External Terminations**	128240-01
I/O Module with Internal Barriers (Internal Terminations)*	135489-01
TMR I/O Module with External Terminations**	126632-01
External Termination Block (Euro Style connectors)*	125808-02
External Termination Block (Terminal Strip connectors)*	128015-02
Recorder External Termination Block* (Euro Style connectors)	128702-01
Recorder External Termination Block* (Terminal Strip connectors)	128710-01
Bussed External Termination Block*,** (Euro Style connectors)	132242-01

Bussed External Termination Block*,** (Terminal Strip connectors)	132234-01
3500/42 I/O Module four pin connector shunt	00530843
3500/42 Monitor Manual	129773-01

Note

- * External Termination Blocks can not be used with the Discrete I/O Module with Internal Terminations (128229-01 and 135489-01).
-
- ** Use the two Bussed External Termination Blocks with the TMR I/O Module only (126632-01).
-
- --When ordering I/O Modules with External Termination, the External Termination Blocks and Cables must be ordered

3500 Transducer (XDCR) Signal to External Termination (ET) Block Cable

Part number 129525 - AXXXX - BXX

A Cable Length

0005	5 feet (1.5 metres)
0007	7 feet (2.1 metres)
0010	10 feet (3 metres)
0025	25 feet (7.5 metres)
0050	50 feet (15 metres)
0100	100 feet (30.5 metres)

B Assembly Instructions

00	Not Assembled
01	Assembled

3500 Recorder Output to Recorder External Termination (ET) Block Cable

Part number 129529 - AXXXX - BXX

A Cable Length

0005	5 feet (1.5 metres)
0007	7 feet (2.1 metres)
0010	10 feet (3 metres)
0025	25 feet (7.5 metres)
0050	50 feet (15 metres)
0100	100 feet (30.5 metres)

B Assembly Instructions

00	Not Assembled
01	Assembled

8. Specifications

INPUTS

Signal:	Accepts from 1 to 4 signal inputs.
Input Impedance:	(Proximitors and Acceleration Inputs)
Standard I/O:	10 k Ω
TMR I/O:	50 k Ω (Bussed Transducer Configuration) 150 k Ω (Discrete Transducer Configuration)
Power:	Nominal consumption of 7.7 watts
Sensitivity:	
Radial Vibration:	3.94 mV/ μ m (100 mV/mil) or 7.87 mV/ μ m (200 mV/mil)
Thrust:	3.94 mV/ μ m (100 mV/mil) or 7.87 mV/ μ m (200 mV/mil)
Eccentricity:	3.94 mV/ μ m (100 mV/mil) or 7.87 mV/ μ m (200 mV/mil)
Differential Expansion:	.394 mV/ μ m (10 mV/mil) or .787 mV/ μ m (20 mV/mil)
Acceleration:	10 mV/(m/s ²) (100 mV/g)
Velocity:	20 mV/(mm/s) pk (500 mV/(in/s) pk), 5.8 mV/(mm/s) pk (145 mV/(in/s) pk), 4 mV/(mm/s) pk (100 mV/(in/s) pk)

OUTPUTS

Front Panel LED's:	
OK LED:	Indicates when the 3500/42 is operating properly.
TX/RX LED:	Indicates when the 3500/42 is communicating with other modules in the 3500 rack.
Bypass LED:	Indicates when the 3500/42 is in Bypass Mode.
Buffered Transducer Outputs:	The front of each monitor has one coaxial connector for each channel. Each connector

is short circuit protected.

Output Impedance:	550 Ω
Transducer Supply Values:	-24 Vdc
Recorder:	+4 to +20 mA. Values are proportional to monitor full scale. Individual recorder values are provided for each channel. Monitor operation is unaffected by short circuits on recorder outputs.
Voltage Compliance (current output):	0 to +12 Vdc range across load. Load resistance is 0 to 600 Ω .
Resolution:	0.3662 μ A per bit \pm 0.25 % error at room temperature -0.66 to +0.70 % error over temperature range updated rate 100 ms or less.

SIGNAL CONDITIONING

Specified at +25° C (77° F)

Radial Vibration

Frequency Response:

Direct Filter: User-programmable for 4 to 4,000 Hz or 1 to 600 Hz.

Gap Filter: -3 dB at .09 Hz.

*Not 1X Filter: 60 cpm to 16 times running speed. Constant Q notch filter. Minimum rejection in stopband of -34.9 dB.

*Smax: 0.125 to 16 times running speed.

*,**1X & 2X Vector Filter: Constant Q Filter. Minimum rejection in stopband of -57.7 dB.

* Note - 1X & 2X Vector, Not 1X, and Smax parameters are valid for machine speeds of 60 to 60,000 cpm.

**Note - Minimum Signal Amplitude for Phase measurement is 42.7 mV

Accuracy:

Direct and Gap: Within \pm 0.33 % of full scale typical, \pm 1 % maximum.

1X & 2X: Within ± 0.33 % of full scale typical, ± 1 % maximum.

Within ± 5 % maximum.

Smax: ± 3 % for machine speeds less than 30,000 cpm. ± 8.5 % for machine speeds greater than 30,000 cpm.

Not 1X:

Thrust and Differential Expansion:

Frequency Response:

Direct Filter: -3 dB at 1.2 Hz.

Gap Filter: -3 dB at 0.41 Hz.

Accuracy: Within ± 0.33 % of full scale typical, ± 1 % maximum.

EIPP Monitor

Frequency Response:

Direct Filter: -3 dB at 15.6 Hz.

Gap Filter: -3 dB at 0.41 Hz.

Accuracy: Within ± 0.33 % of full scale typical, ± 1 % maximum.

Acceleration Frequency Response

The following table represents the frequency ranges for the 3500/42 under different filtering options. Resources used for filtering are assigned based on channel pairs. It is possible to select different filtering options for the two channels of a channel pair. However, the frequency response for both channels will be limited to the worst case frequency response of the individual channels. If added frequency range is required, the 3500/42 can be configured as a two-channel monitor (use channels 1 and 3). This lets you combine the resources normally used for filtering of two channels and use them for one. See page 56

Dual Acceleration

Filter Quality:

High-Pass: 4-pole (80 dB per decade, 24 dB per octave).

Low-Pass:	4-pole (80 dB per decade, 24 dB per octave).
Quality:	Within ± 0.33 % of full-scale typical, ± 1 % maximum. Exclusive of filters.
Dual Velocity	
Frequency Response:	See page 67
Filter Quality:	
High-Pass:	2-pole (40 dB per decade, 12 dB per octave).
Low-Pass:	2-pole (40 dB per decade, 12 dB per octave).
Quality:	Within ± 0.33 % of full-scale typical, ± 1 % maximum. Exclusive of filters. For the Velomitor: Full Scale 0-0.5: ± 3 % typical. Full Scale 0-1.0: ± 2 % typical. Full Scale 0-2.0: ± 1 % typical.

ALARMS

Alarm Setpoints:	Alert levels can be set for each value measured by the monitor. In addition, Danger setpoints can be set for any two of the values measured by the monitor. All alarm setpoints are set using software configuration. Alarms are adjustable and can normally be set from 0 to 100 % of Full Scale for each measured value. The exception is when the Full Scale range exceeds the range of the transducer. In this case, the set point will be limited to the range of the transducer. Accuracy of alarms are to within 0.13 % of the desired value.
------------------	--

Alarm Time Delays:	Alarm delays can be programmed using software, and can be set as follows:
Alert:	From 1 to 60 seconds in 1 second intervals.
Danger:	0.1 seconds (typical) or from 1 to 60 seconds in 1 second intervals.

PROPORTIONAL VALUES

Proportional values are vibration measurements used to monitor the machine. The Proximitors/Seismic Monitor returns the following proportional values:

Radial Vibration	Thrust Position	Differential Expansion
Direct * Gap 1X Amplitude 1X Phase Lag 2X Amplitude 2X Phase Lag Not 1X Amplitude Smax Amplitude	Direct * Gap	Direct * Gap
Eccentricity	Acceleration	
Peak to Peak * Gap Direct Min Direct Max	Direct * RMS Acceleration (or) peak Acceleration (or) RMS Velocity (or) peak Velocity (or) Band-pass peak Acceleration (or) Band-pass peak Velocity	
Velocity		

Direct *

RMS Velocity (or)

peak Velocity

peak to peak Displacement (or)

Band-pass peak Velocity (or)

Band-pass peak to peak Displacement

* This is the primary value for each channel pair type.

ENVIRONMENTAL LIMITS

Temperature: -30 to 65° C (-22 to 150° F) operating, when used with Internal/External Termination Proximitors/Seismic I/O Module.

0 to 65° C (32 to 150° F) operating, when used with Proximitors/Seismic Internal Barrier I/O Module (Internal Termination).

-40 to 85° C (-40 to 185° F) storage.

Humidity: 95 % non-condensing.

BARRIER PARAMETERS

The following parameters apply for both CSA-NRTL/C and CENELEC approvals.

Proximitors Barrier:

Circuit Parameters:

V _{max} (PWR) = 26.80 V
(SIG) = 14.05 V
I _{max} (PWR) = 112.8 mA
(SIG) = 2.82 mA
R _{min} (PWR) = 237.6 Ω
(SIG) = 4985 Ω

Channel Parameters (Entity):

V _{max} = 28.0 V
I _{max} = 115.62 mA
R _{min} (PWR) = 237.6 Ω
(SIG) = 4985 Ω

Seismic Barrier:

Circuit Parameters: Vmax (B) = 27.25 V
 Imax (B) = 91.8 mA
 Rmin (B) = 297 Ω

Channel Parameters
(Entity): Vmax = 27.25 V
 Imax = 91.8 mA
 Rmin = 297 Ω

ELECTROMAGNETIC COMPATIBILITY

Note: The 3500 Monitoring System conforms to the specifications listed below. The specific test setup, test levels, and pass criteria (monitor accuracy) for these tests are defined in the 3500 Technical Construction File. For copies of this file, contact your local Bently Nevada office.

EN50081-2:

Radiated Emissions: EN 55011, Class A

Conducted Emissions: EN 55011, Class A

EN50082-2:

Electrostatic Discharge: EN 61000-4-2 (1995), Criteria B

Radiated Susceptibility: ENV 50140 (1993), Criteria A

Conducted Susceptibility: ENV 50141 (1993), Criteria A

Electrical Fast Transient: EN 61000-4-4, Criteria B

Surge Capability: EN 61000-4-5, Criteria B

Magnetic Field: EN 61000-4-8, Criteria A

Power Supply Dip: EN 61000-4-11, Criteria B

Radio Telephone: ENV 50204, Criteria B

HAZARDOUS APPROVALS

CSA-NRTL/C:
When used with Internal/External Termination I/O Module Class I, Division 2, Groups A through D

When used with Internal Barrier I/O Module (Internal Termination) * Class I, Division 1, Groups A through D
Class II, Division 1, Groups E, F, G
Class III

* Hazardous Approvals for Class I, Division 2, Groups A through D Pending.

CENELEC:
When used with Internal Barrier I/O Module (Internal Termination) [EEx ia] IIC

PHYSICAL

Main Board:
Dimensions (Height x Width x Depth) 241.3 mm x 24.4 mm x 241.8 mm
(9.50 in x 0.96 in x 9.52 in)

Weight: 0.91 kg (2.0 lbs)

I/O Modules (non-barrier):
Dimensions (Height x Width x Depth) 241.3 mm x 24.4 mm x 99.1 mm
(9.50 in x 0.96 in x 3.90 in)

I/O Modules (barrier):
Dimensions (Height x Width x Depth) 241.3 mm x 24.4 mm x 163.1 mm
(9.50 in x 0.96 in x 6.42 in)
Weight: 0.20 kg (0.44 lbs), non-barrier
0.46 kg (1.01 lbs), barrier

RACK SPACE REQUIREMENTS

Monitor Module: 1 full-height front slot

I/O Modules: 1 full-height rear slot