



## **MasterLogic-200**

### **Specifications and Technical Data**

**Release R200**

Revision Date: May, 2010

Version 4.0

## **Release 200**

## Contents

<b>1. INTRODUCTION .....</b>	<b>4</b>
1.1 OVERVIEW .....	4
1.2 MASTERLOGIC-200 PLC SYSTEM ARCHITECTURE .....	5
1.3 GENERAL SPECIFICATIONS .....	7
1.4 CPU SUMMARY SPECIFICATIONS .....	9
1.5 POWERFUL & VERSATILE CPU.....	13
1.6 POWER SUPPLY MODULES (2MLI-CPUU).....	32
1.7 POWER SUPPLY MODULES (2MLR-CPUH/#).....	34
1.8 BASE OPTIONS (2MLI-CPUU).....	35
1.9 BASE OPTIONS (2MLR-CPUH/#).....	38
1.10 I/O INTERFACE MODULES (2MLR-CPUH/#) .....	41
<b>2. OPEN NETWORKS.....</b>	<b>42</b>
2.1 NETWORK SUMMARY SPECIFICATIONS .....	42
2.2 FAST ETHERNET (FENET).....	44
2.3 SERIAL COMMUNICATION (SNET) .....	50
2.4 PROFIBUS-DP (PNET).....	54
<b>3. SOFTMASTER .....</b>	<b>56</b>
<b>4. MODEL NUMBERS .....</b>	<b>61</b>
4.1 CPU MODULES .....	61
4.2 I/O BASE, CABLES (2MLI-CPUU).....	61
4.3 I/O BASE, I/O INTERFACE MODULES, CABLES (2MLR-CPUH).....	62
4.4 DIGITAL I/O MODULES .....	63
4.5 ANALOG I/O, HSC MODULES.....	65
4.6 COMMUNICATION MODULES .....	66
4.7 PROGRAMMING CABLES.....	66
4.8 SOFTWARE ENVIRONMENT.....	66
4.9 OTHERS.....	67

## Revision History

---

Revision	Date	Changes
1.0	September 2007	Initial Version
2.0	January, 2008	Included details on MasterLogic 200R
3.0	Sep, 2008	Updated MasterLogic 200R Specifications
4.0	May, 2010	Removed Experion PKS introduction, Included ML200R DC24V power supply , Removed Smart IO and Position Control Module

**Legend for Change Column:**

A – Added

D – Deleted

M – Modified

# 1. Introduction

## 1.1 Overview

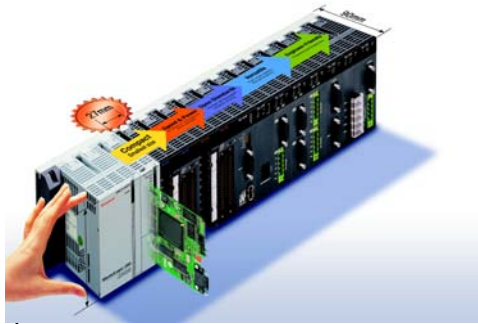

MasterLogic-200, Honeywell's next generation Programmable Logic Controllers (PLC), adds power and robustness to logic-interlock-sequence batch control capabilities of Experion network.

It is state of the art, compact yet powerful & versatile, cost-effective solution ideal for fast logic, sequential, and batch control applications

The highlights of MasterLogic-200 PLC system are:

- Powerful & Versatile CPU (high speed / memory, IEC programming etc)
- Compact footprint (Rack room, cabinet space saver, shipping costs saver)
- Modular options (power supply, range of I/O modules to suit your configuration)
- Flexibility in module assignment – any module can be installed in any slot of any base without any restrictions.
- Open networks (Fast Ethernet, UTP/Fiber-Optic, serial RS232C /422/485)
- Open protocols (Profibus-DP, MODBUS ASCII/RTU/TCP)
- Peer-to-Peer networks (Dedicated Fast Ethernet on UTP/Fiber-optic)
- Simulation Environment to test control strategies without hardware or process connections.
- Engineer-friendly software (Connection options, easy configuration & trouble-shooting)
- Diagnostics (System/Error Logs, system monitoring, network monitoring, ping test, frame monitor)
- Experion PKS & Experion HS Integration (PLC alarm/events, clock synch, etc)

- Redundancy (CPU, Power, I/O network redundancy)

## 1.2 MasterLogic-200 PLC system architecture

### Redundancy options

MasterLogic-200 provides the control system designer with various redundancy architecture options that fits the requirement.

#### ***Fully Redundant system***

CPU Model: 2MLR-CPUH/# provides a fully redundant system:

- Redundant CPU
- Redundant Power
- Redundant I/O cable (ring topology with dual paths)

#### ***Non-redundant system***

For cost-effective applications, CPU Model: 2MLI-CPUU provides a fully non-redundant system:

- Non-redundant CPU
- Non-redundant Power
- Non-redundant I/O cable

#### ***Non-redundant CPU but Redundant Power and I/O cable***

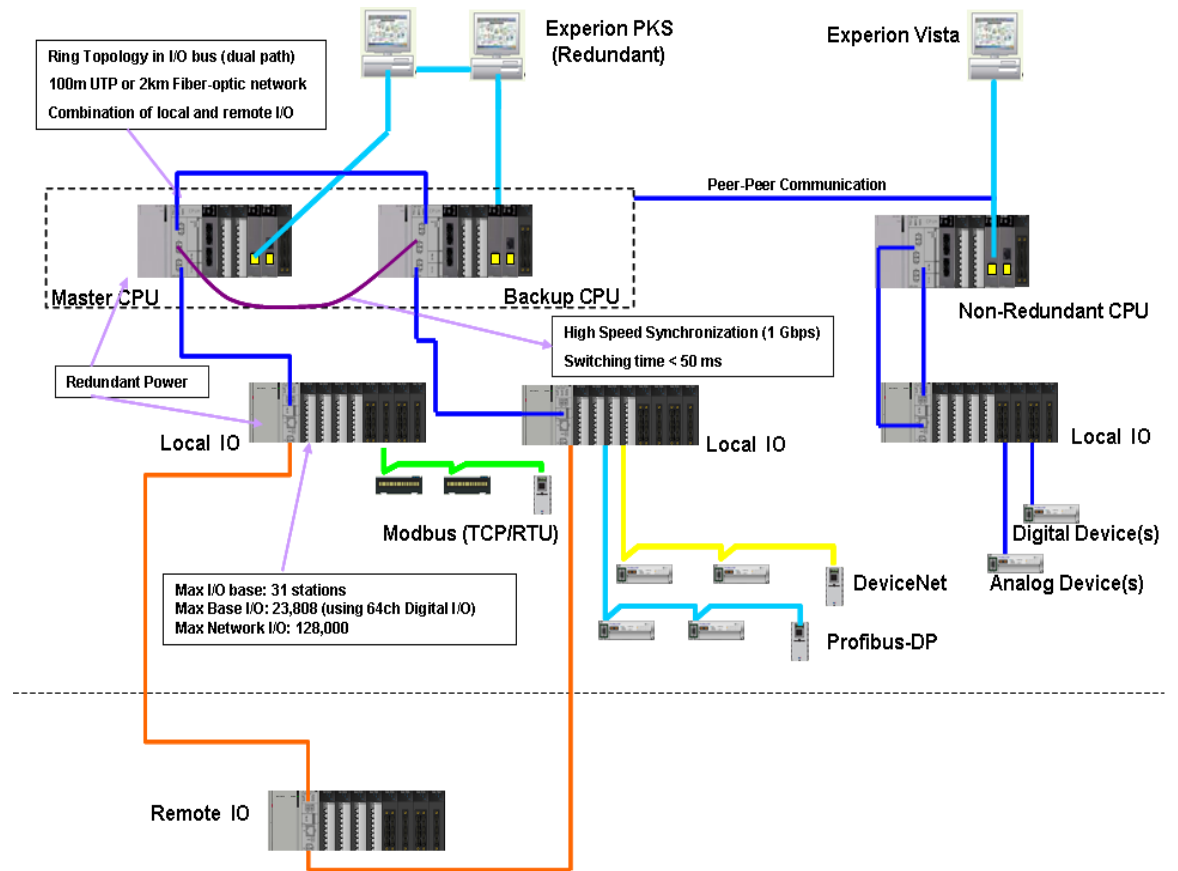

A slight variation of the fully redundant architecture with only the master CPU of 2MLR-CPUH/# (excluding the standby CPU) offers the functionality of:

- Non-Redundant CPU
- Redundant Power
- Redundant I/O cable (ring topology with dual paths)



### 1.3 General Specifications

No.	Item	Specifications	Related Standards			
1	Ambient Temp.	0 ~ 55°C				
2	Storage Temp.	-25 ~ +70°C				
3	Ambient humidity	5 ~ 95%RH (Non-condensing)				
4	Storage humidity	5 ~ 95%RH (Non-condensing)				
5	Vibration	Occasional vibration		-	IEC61131-2	
		Frequency	Acceleration	Pulse width		Sweep Count
		$10 \leq f < 57\text{Hz}$	-	0.075mm		10 times each direction (X, Y and Z)
		$57 \leq f \leq 150\text{Hz}$	9.8m/s <sup>2</sup> (1G)	-		
		Continuous vibration				
		Frequency	Acceleration	Pulse width		
		$10 \leq f < 57\text{Hz}$	-	0.035mm		
		$57 \leq f \leq 150\text{Hz}$	4.9m/s <sup>2</sup> (0.5G)	-		
6	Shocks	<ul style="list-style-type: none"> <li>Peak acceleration: 147m/s<sup>2</sup>(15G)</li> <li>Duration: 11ms</li> <li>Pulse wave type: Half-sine (3 times in each of X, Y and X directions)</li> </ul>	IEC61131-2			
7	Noise immunity	Square wave impulse noise	±1,500V			
		Electrostatic discharge	Voltage: 4kV (Contact discharge)	IEC61131-2 IEC61000-4-2		

		Radiated electromagnetic field noise	27 ~ 500MHz, 10V/m			IEC61131-2, IEC61000-4-3
		Fast transient /Burst noise	Classification	Power supply	Digital/Analog Input/Output, Communication Interface	IEC61131-2 IEC61000-4-4
			Voltage	2kV	1kV	
8	Atmosphere	Free from corrosive gases and excessive dust				
9	Altitude	Less than 2,000m				
10	Pollution degree	Less than 2				
11	Cooling method	Air-cooling				
12	Agency Certifications		UL 508 Industrial Control Equipment			
			89/336/EEC, EMC Directive EN 50081-2, Emissions, Industrial EN 50082-2, Immunity, Industrial			

**Note:**

**IEC (International Electrotechnical Commission)** – An international civil community that promotes international cooperation for standardization of electric/ electro technology, publishes international standard and operates suitability assessment system related to the above.

**Pollution Degree** – An index to indicate the pollution degree of used environment that determines the isolation performance of the device. For example, pollution degree 2 means the state to occur the pollution of non-electric conductivity generally, but the state to occur temporary electric conduction according to the formation of dew.

Compliance to European Union Directives. This product has the CE mark and is approved for installation within the European Union and EEA regions. It has been designed and tested to meet the following directives:

**EMC Directive.** This apparatus is tested to meet Council Directive 89/ 336/ EEC Electromagnetic Compatibility (EMC) using a technical construction file and the following standards, in whole or in part:

- EN 50081- 2 EMC – Generic Emission Standard, Part 2 – Industrial Environment
- EN 50082- 2 EMC – Generic Immunity Standard, Part 2 – Industrial Environment

The product described in this document is intended for use in an industrial environment.

**Low Voltage Directive.** This product is also designed to meet Council Directive 73/ 23/ EEC Low Voltage, by applying the safety requirements of EN 61131– 2 Programmable Controllers, Part 2 – Equipment Requirements and Tests.



## 1.4 CPU Summary Specifications

No.	Item	Specifications		Related Standards	
		2MLI-CPUU Non-redundant	2MLR-CPUH/# Redundant or Non-redundant		
1	Program Execution methods	Cyclic scan, Time-driven interrupts, Internal Memory interrupts			
2	I/O control method	Scan synchronous batch processing I/O (refresh method), Direct I/O method by program instruction			
3	Program language	Ladder Diagram, Sequential Function Chart, Structured Text, Instruction List (view only)			
4	Number of instructions	Operator	18		
		Basic functions	136 + real number operation function	130 + real number operation function	
		Basic function block	43	41	
		Dedicated function block	Special function blocks, Process function blocks Dedicated communication function blocks (P2P)		
5	Processing speed (Basic instruction)	LD	0.028 $\mu$ s/Step	0.042 $\mu$ s/Step	
		MOV	0.084 $\mu$ s/Step	0.112 $\mu$ s/Step	
		Real number operation	$\pm$ : 0.392 $\mu$ s (S), 0.924 $\mu$ s (D) $\div$ : 0.924 $\mu$ s (S), 2.254 $\mu$ s (D) x: 0.896 $\mu$ s (S), 2.240 $\mu$ s (D)	$\pm$ : 0.602 $\mu$ s (S), 1.078 $\mu$ s (D) $\div$ : 1.106 $\mu$ s (S), 2.394 $\mu$ s (D) x: 1.134 $\mu$ s (S), 2.660 $\mu$ s (D)	S: Single real number D: Double real number
6	Program memory	7 MB			
7	Max # I/O bases	8 (main + 7 extension)	31		
8	Max # slots	96	372		
9	Max base I/O	Using 64 ch DI/DO module	6,144 (64ch * 96 slots)	23,808 (64ch*372 slots)	
		Using 32 ch DI/DO module	3,072 (32ch * 96 slots)	11,904 (32ch*372 slots)	
10	Max I/O extension distance	15m (proprietary cable)	100m (UTP cable) 2km (Fiber-optic cable)	+open standards	

11	Max Network / Remote I/O	128,000	128,000	Using network I/O	
12	Flash Memory	16 MB			
13	Data Memory Capacity	Symbolic Variable Area (A)	512 KB (Maximum, 256 KB retain settable)		
		Timer	No point limit Time Range: 0.001 ~ 4,294,967.295 seconds (1,193hours)		Occupying 20 bytes of symbolic variable area per point
		Counter	No point limit Coefficient Range : -32,768 ~ +32,767		Occupying 8 bytes of symbolic variable area per point
		Direct Variable	M	512 KB	Fixed Area Variable
			R	64 KB * 2 (%RW0~%RW32767)	File Register (uses flash memory)
			I	16 KB (%IW0.0.0~%IW127.15.3)	Input Image Area
			Q	16 KB (%QW0.0.0~%QW127.15.3)	Output Image Area
			W	128 KB (%WW0~%WW65535)	File Register (uses flash memory)
		Flag Variables	F	4 KB	System Flag
			K	18 KB (PID 256 loops)	PID Flag
			L	22 KB	High Speed Link Flag
			N	42 KB	P2P Flag
			U	32 KB	Analog Refresh Flag as VAR_GLOBAL

14	Program Type Allocation	INIT task	1max		
		Timer Interrupt tasks	32 max		
		Internal Device Interrupt tasks	32 max		
		Scan program	Balance: 256 minus sum of above		
		Total	256 max		
15	CPU operation mode	RUN, STOP, DEBUG			
16	CPU restart mode	Cold or warm restart			
17	Self-diagnosis	Watchdog timer, memory error, I/O error, battery error, power error, communication error etc.			
18	Built-in Program port	RS-232C(1CH)		Modbus slave supported via RS-232C port	
		USB (1CH) @ 12MBPS			
		Note: Additional program connections via Ethernet & serial communication module (locate or remote)			
19	Data storage method at power off	Retain area configuration via Basic parameters			
20	Current consumption (mA)	960	1173 (2MLR-CPUH/T) 1360 (2MLR-CPUH/F)		
21	Weight (kg)	0.12	0.257 (2MLR-CPUH/T) 0.276 (2MLR-CPUH/F)		
22	<b>Redundancy Feature</b>				
	Watchdog between CPUs	NA	Sync cable and Ring-type I/O Network		
	Data Backup	NA	1Gbps Fiber Optic, max. 200m		
	Synchronization Method	NA	Configured in Redundancy parameter		
	Sync Cable Specification	NA	62.5/125 Multi-mode Fiber LC type connector (Lucent Connector) Return Loss : over 45db		
	Delay time for redundant	NA	Varies with data size		

	operation		between CPUs - Default: 8.2ms / max. 80ms	
	Switchover Time	NA	22ms	
	Operation delay during switchover	NA	Max. time of delay time for redundant operation	

## 1.5 Powerful & Versatile CPU

### High Speed

Facilitated by a powerful state of the art processor (NGP1000), MasterLogic-200 CPU provides high speed execution of program instructions and backplane/communication data transfers. In addition, dedicated intelligent communication modules (Ethernet, Serial, Profibus etc) offer co-processing assistance to the main controller CPU.

### High Memory

High memory of MasterLogic-200 CPU combined with high speed & huge I/O capacity feature provides a robust platform for efficient performance in large applications.

Summary specification for CPU Models: 2MLI-CPUU & 2MLR-CPUH/#

Memory Specification	Memory size	Remarks
Total Memory	25 MB	
Built-in Flash Memory	16 MB	For program & data backup
Program Memory (Incl. System Memory)	7 MB	For program execution, upload, system parameters, history logs
Data Memory	2 MB	Direct variables & Symbolic (named) variables

### Free slot assignment

This is good news to engineers handling base/slot assignment. MasterLogic-200 poses no restriction whatsoever. Any module type i.e. digital I/O, analog I/O, HSC (pulse input), RTD, Thermocouple, and even communication modules (i.e. Ethernet, Serial, Profibus-DP, DeviceNet) can be freely assigned to any base/slot irrespective of base #, Slot #.

Without any restriction, any of the above modules (except for Ethernet module) can also be installed in remote I/O bases located far away (by using FO network of 2MLR-CPUH/#).

### Large I/O capacity

MasterLogic-200 accommodates a huge I/O capacity through base I/O and remote/network I/O capabilities. The I/O capacity details are tabulated as follows:

#### **Model: 2MLI-CPUU (Non-redundant)**

Model: 2MLI-CPUU	Qty	Remarks	
Max # of bases	8	1 main base + 7 extension bases	
Max # of slots	96	12 slots * 8 base = 96 slots	
Base I/O	6,144 points	Using 64 ch DI/DO module	96 slots * 64 ch = 6,144 points
	3,072 points	Using 32 ch DI/DO module	96 slots * 32 ch = 3,072 points
Network & Remote I/O (Max I/O memory)	128,000 points	Using network I/O	

#### **Model: 2MLR-CPUH/# (Non-redundant or Redundant)**

Model: 2MLR-CPUH/#	Qty	Remarks	
Max # of I/O bases	31	On either Ethernet or Fiber-optic networks	
Max # of slots	372	12 slots * 31 base = 372 slots	
Base I/O	23,808 points	Using 64 ch DI/DO module	372 slots * 64 ch = 23,808 points
	11,904 points	Using 32 ch DI/DO module	372 slots * 32 ch = 11,904 points
Network I/O (Max I/O memory)	128,000 points	Using network I/O modules.	

### High Speed Synchronization

In redundant CPU systems, a dedicated high speed 1Gigabit fiber-optic link between primary and backup CPU ensures efficient synchronization of data and program memory areas. Upon failure of the primary CPU, the control switches over to the backup CPU bumplessly in less than 50 msec.

### IEC 61131-3 Standard Programming Languages

MasterLogic-200 PLCs do not restrict the control engineers with a solitary ladder programming (LD) language. Their work is made easier with a choice of IEC standard programming languages. Each of the IEC 61131-3 standard programming language is designed for a specific application.

#### Ladder (LD)

MasterLogic-200 provides a friendly ladder (LD) programming editor, best suited for relay logic / interlocks with timers and counters. The same editor serves as online monitoring display for trouble-shooting situations.

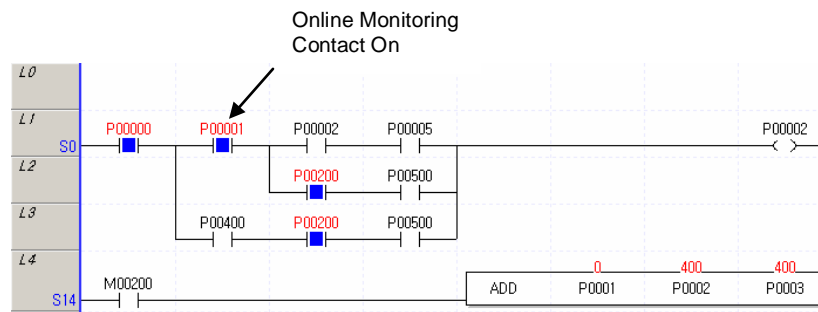

#### Sequential Function Chart (SFC)

However, ladder would be cumbersome for the engineer to build strategies for sequencing/batching applications with state/transition conditions. Sequential Function Chart (SFC) visual programming editor best suited for that purpose is provided.

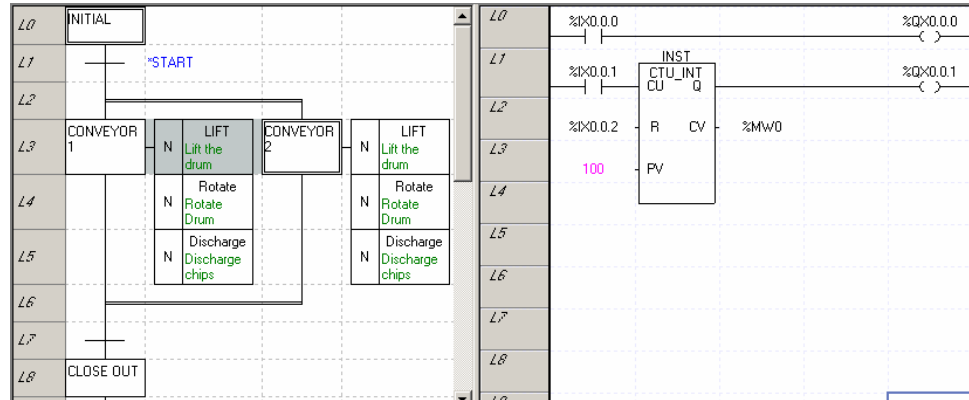

### Structured Text (ST)

Likewise, so as to build a own library of user-defined function blocks or being accustomed to computer languages like BASIC, PASCAL etc, the engineer would be inclined to pick Structured Text (ST) language as the right choice.

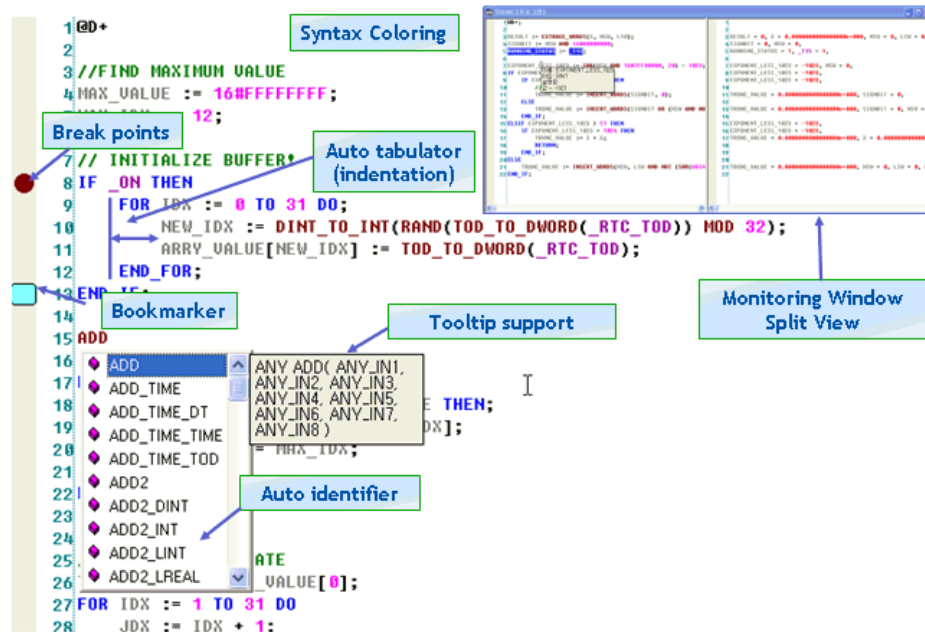



**Instruction List (IL – View only mode)**

A mnemonic assembly-type programming language (currently in view only mode) to assist to cross-verification of ladder program sequences.

1	LOAD		%IX0.0.0
2	OUT		%QX0.1.0
3	LOAD		%IX0.0.1
4	OUT		%QX0.1.1
5	LOAD		%IX0.0.2
6	OUT		%QX0.1.2

**Flexibility to mix & match**

MasterLogic-200 empowers the control engineer with flexibility to mix & match different languages in a single CPU with modular programs, each serving a specific requirement typical to industrial process control situations.

Programming Language	Remarks
LD (Ladder)	Relay logic / interlocks
SFC (Sequential Function Chart)	State / Transition diagrams for sequential/batch applications
ST (Structured Text)	BASIC, PASCAL like programming language
FB (Function Block)	To be used / embedded in other programming languages e.g. LD, SFC, ST
IL (Instruction List)	View only mode of LD instructions

### Program Types & Modular Programs

MasterLogic-200 allows modularizing the whole control strategy for the PLC into max. 256 easily manageable sub-programs, executed either cyclically once every scan in the order or interrupt driven based on timer or memory conditions.

Program Type	Max #	Task #	When executed?
INIT Program	1		Executed once during PLC startup
Timer Interrupts	32	0~31	Executed when timer interval elapses (configurable @ 1msec resolution)
Device Interrupts	32	64~95	Executed when configured internal memory condition occurs
Scan Programs	Balance		Executed once every scan
<b>Total</b>	<b>256</b>		

Note: Task ID 32~63 reserved for future use (I/O interrupt conditions)

### Cold or Warm Restart Options

MasterLogic-200 provides two CPU restart modes, cold or warm options to fit the restart circumstances.

Mode Parameter	Cold Restart	Warm Restart
Default	Initializing as '0'	Initializing as '0'
Retain	Initializing as '0'	Maintaining the previous value
Initialization	Initializing as a user-defined value	Initializing as a user-defined value
Retain and initialization	Initializing as a user-defined value	Maintaining the previous value

**IEC data types**

The following are IEC standard data types supported by MasterLogic-200 programs in accessing direct & symbolic (named) variables. Variables can be defined as local (accessible only within the program) or global variables (accessible across all programs).

<b>Data Category</b>	<b>Data types supported</b>
Bit	BOOL
Byte	BYTE
Word	WORD, DWORD, LWORD
Integer	SINT, INT, DINT, LINT
Unsigned Integer	USINT, UINT, UDINT, ULINT
Real	REAL (Single precision), LREAL (Double precision)
Date & Time	TIME, DATE, TIME_OF_DAY, DATE_AND_TIME
Text Character	STRING
Array	ARRAY (3-dimensional arrays, max array size of 32767 elements)
User-defined data type	STRUCT
Function Block instances	FB_INST

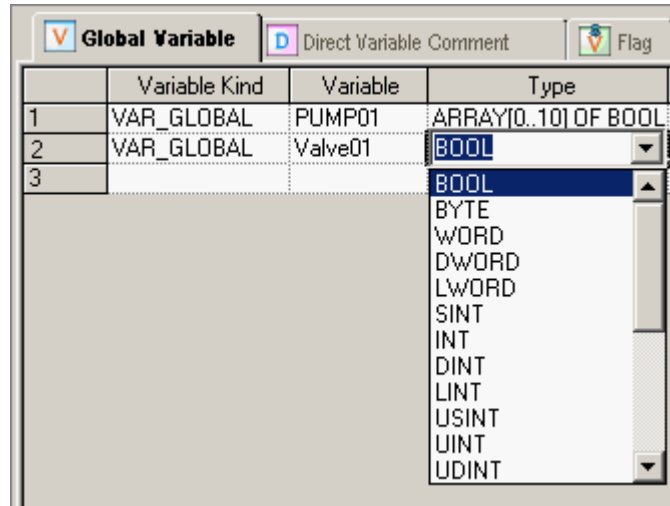

**Three-dimensional arrays**

Array variables are extremely useful to a programmer to store a series of related data items. For example, an array variable Tank\_Level[0..9] can be used to store level values of a max of 10 similar tanks typically using “for loop” command.

	Variable Kind	Variable	Type	AT	Initial Value	Retain	Used	Comment
1	VAR	AVE_HOURLY	ARRAY[0..23] OF WORD			<input type="checkbox"/>	<input type="checkbox"/>	Single Dimensional Array
2	VAR	AVE_DAILY	ARRAY[0..23,0..30] OF WORD			<input type="checkbox"/>	<input type="checkbox"/>	Two Dimensional Array
3	VAR	AVE_MONTHLY	ARRAY[0..23,0..30,0..11] OF WORD			<input type="checkbox"/>	<input type="checkbox"/>	Three Dimensional Array
4						<input type="checkbox"/>	<input type="checkbox"/>	

**Function Block & Instruction Library**

Drastically reducing engineering time, a vast library of instructions & function blocks is pre-built and packaged with MasterLogic-200 system. Here is an overview of the function block library available for the control engineer.

Function Type	Functions / Function Blocks
Input Contacts <sup>+</sup>	NC/NO Contact , ±Transition contacts

Coils <sup>†</sup>	Coil/Negated coils, Set/Reset coils (latch), $\pm$ Transition sensing coils
Data type conversions	Bool_to_*, Byte_to_*, Word_to_*, Int*_to_*, UInt*_to_*, Real*_to_*, Time_to_*, Date_to_*, String_to_*, BCD_to_*, *_to_BCD
Bit functions	AND, OR, NOT, XOR, XNR, SHL, SHR, ROL, ROR etc.
ARRAY functions	Move, Rotate, Compare, Fill, Average, Shift etc.
Comparison Functions	GT, EQ, GE, LT, LE, NE
Timer	On Delay, Off Delay, Pulse Timers...
Counter	Count up, Count Down, Count Up/Down...
String Functions	CONCAT, LEFT, RIGHT, MID, INSERT, DELETE, REPLACE...
Process Control	Average, Delay, Limit, Rate, Summer, Totalizer, Analog_Selector, Function Generator, Lead Lag PID with auto tuning, Cascade control , Ratio Control, Alarm, Ramp
Stack Functions	LIFO_***, FIFO_***...
Date & Time functions	Multiply, Subtract, Divide, Add functions on date and time variables
Mathematical functions	Exponential, Degree/Radian, ADD/MUL/DIV/SUB, ABS, MOD, Trigonometric (SIN, COS, TAN...), SQRT, LOG...
Select Functions	Max, Min, Multiplex...
System Control Functions	SCON, DUTY, STOP, ESTOP, DIREC_IN/O, Watchdog reset, Master Clear, Semaphore etc.

<sup>†</sup> Basic instructions in ladder program

**Symbolic (Named) Variables with auto memory allocation**

A significant amount of data memory, as high as 512KB, is allocated for Symbolic variables in MasterLogic-200 CPU. This is equivalent to 50% of the total data memory, thus intensifying the utilization of auto memory allocation.

The control engineers can simply building named variables circumventing the hassles of manual memory allocation and derive the convenience of letting the CPU automatically allocate memory according to the data types. This eliminates human lapses involved in duplicate assignment, unused memory etc.

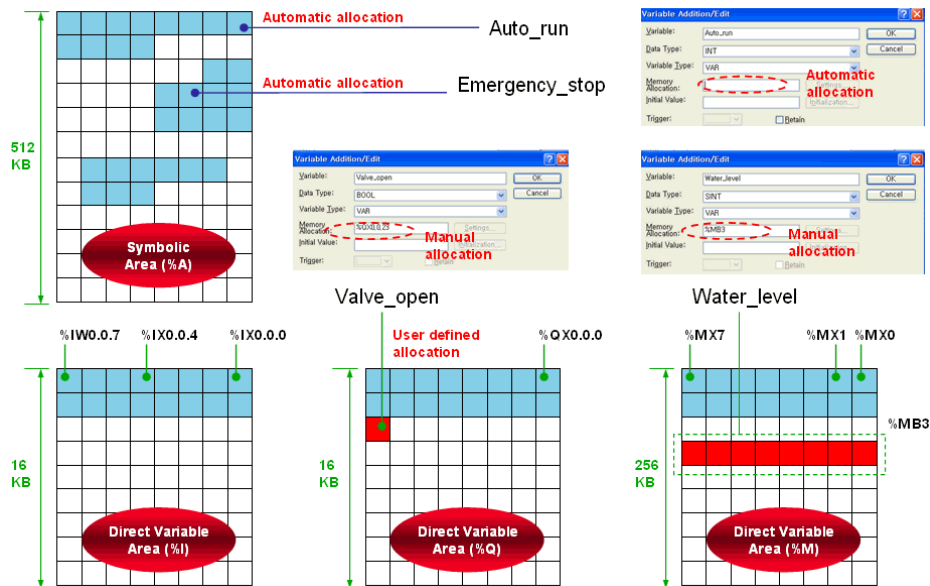

**Retention Memory**

Portions of data memory area provide (non-volatile) memory retention function.

- %R (File Register) memory area comprising 2 blocks of 64KB each serving always as non-volatile memory for the engineers. Data stored here will be retained even upon power failure to CPU and during cold or warm restart options. The data in this area can be cleared only by operating the CPU switch D.CLR for > 3 sec or upon battery failure

- Also the control engineer can selectively configure portion of %M memory areas for memory retention in “Basic Parameters”. A max of 128KB can be configured for memory retention in %M area.

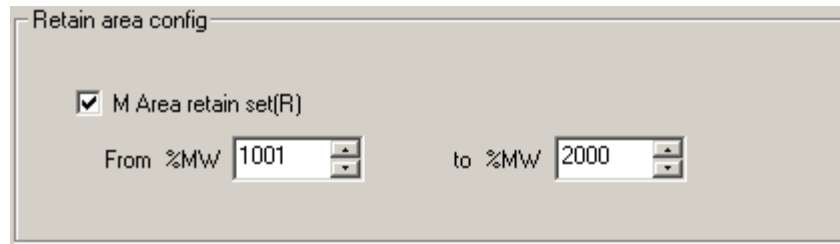

- In addition to the above two, symbolic variables (named variables) occupying 512KB of data memory (local and global) can be individually configured for memory retention during variable declaration phase.

	Variable Kind	Variable	Type	AT	Initial Value	Retain	Used	Comment
1	VAR	AVE_HOURLY	ARRAY[0..23] OF WORD			<input type="checkbox"/>	<input type="checkbox"/>	Single Dimensional Array
2	VAR	AVE_DAILY	ARRAY[0..23,0..30] OF WORD			<input type="checkbox"/>	<input type="checkbox"/>	Two Dimensional Array
3	VAR	AVE_MONTHLY	ARRAY[0..23,0..30,0..11] OF WORD			<input type="checkbox"/>	<input type="checkbox"/>	Three Dimensional Array
4						<input type="checkbox"/>	<input type="checkbox"/>	

Refer to the following table for the maintenance or reset (clear) of the retain area data according to the PLC operation.

Item	Symbolic Variables	M area retain	R area
Reset	Maintaining the previous value	Maintaining the previous value	Maintaining the previous value
Over all reset	Initializing as '0'	Initializing as '0'	Maintaining the previous value
DCLR	Initializing as '0'	Initializing as '0'	Maintaining the previous value
DCLR (3sec)	Initializing as '0'	Initializing as '0'	Initializing as '0'
STOP→RUN*	Warm: Maintaining the previous value	Maintaining the previous value	Maintaining the previous value

	Cold: Initializing as '0'		
--	------------------------------	--	--

\* Cold Restart Mode if the program is downloaded

Please refer to [Cold or Warm Restart Options](#) section to know more about memory retention functions.

### Online Maintenance Functions

#### Hot-swapping

Any faulty I/O module can be swapped online with a new one without having to stop a running CPU. There are two methods:

- o By operating a switch M.XCHG in CPU module (Available for 2MLI-CPUU only)
- o By running a software wizard in SoftMaster

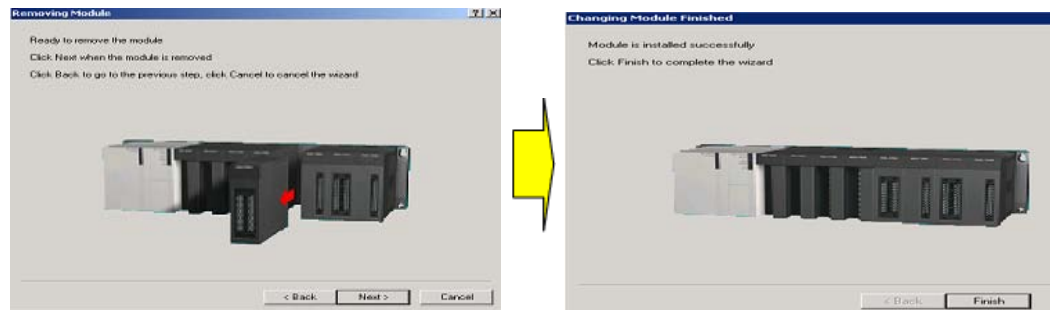

#### Online Editing

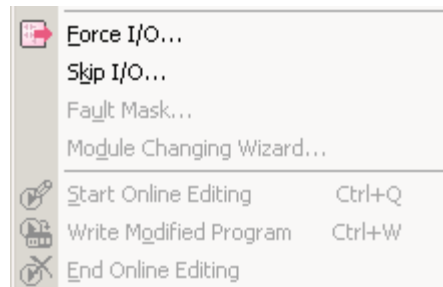

Any part of the PLC program can be edited online when CPU is running & the new program can be downloaded to the CPU without having to stop the CPU.

SoftMaster allows an intermediate step of downloading the modified program to CPU and monitor the outcome. The programmer can continue to make changes if required without quitting the



session.

**Fault Mask**

Fault Mask enables program to continue uninterrupted even if a module error occurs. Fault Mask can be set for any base/slot module either by

- SoftMaster software tool
- Program instruction setting fault mask flag

Only the faulty module stops operating while the overall system continues to operate due to Fault Mask settings. If there is no error in the module, CPU works normally with this setting.

**Skip I/O**

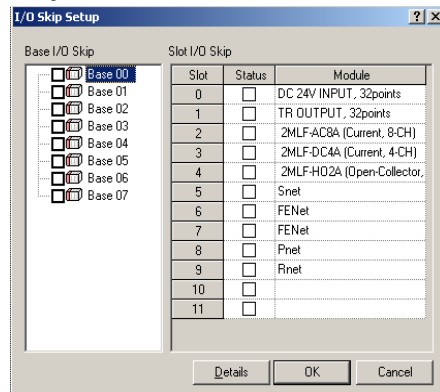

Skip I/O setting for any base/slot module instructs the CPU to skip processing of specified I/O module(s). The input image (%) area would not be refreshed for those modules and output image area will not be transferred to the actual module.

**Force I/O**



This function enables the control engineer to force either ON or OFF values to digital input or output locations in I/O bit image areas.

## Data Trouble-shooting Functions

### Data Tracing

This is one of unique features of MasterLogic PLC. Data tracing works at CPU level, quite different from the trend monitoring feature usually available at software level in many PLCs. Configure the trace parameters (trigger condition, trace variables, sampling size) and trouble-shoot the variables in trend graphic or tabular format.

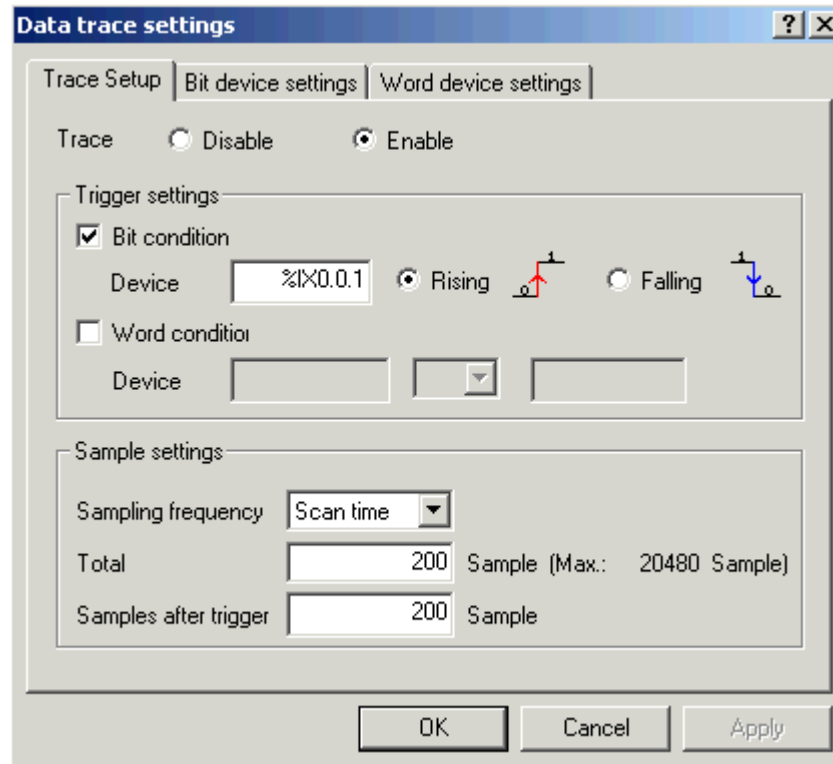

Function	Specification
Data Trace Trigger Condition	Bit variable: Rising, Falling Word variable: <, <=, >, >=, == Also can be manually triggered from SoftMaster
Sampling Frequency options	Scan time, 20ms, 50ms, 100ms, 200ms, 500ms, 1000ms, 2000ms
Total # of samples	Calculated based on trace variable data types
Samples after trigger	Decides whether and how much of samples are needed before or after the trigger
Trace variables	Bit variables: 16 variables max Word variables: 8 variables max
Storage	Trace data will be stored and protected in CPU memory until the trigger condition reoccurs or a new setting is downloaded.
Trace Data Presentation	Optionally in user-friendly graphical tool or tabular data format in MS-Excel

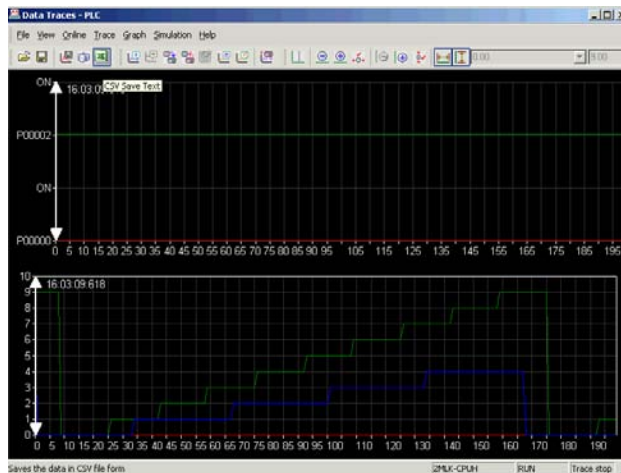

**User-defined Custom Events**

Configure user-defined custom event settings and download to CPU for logging events in database. Trigger conditions can be any bit variable, direct or symbolic. Also 16 variables (bit, word, real data type) can be associated to the event whose current value will be captured when the event is triggered.

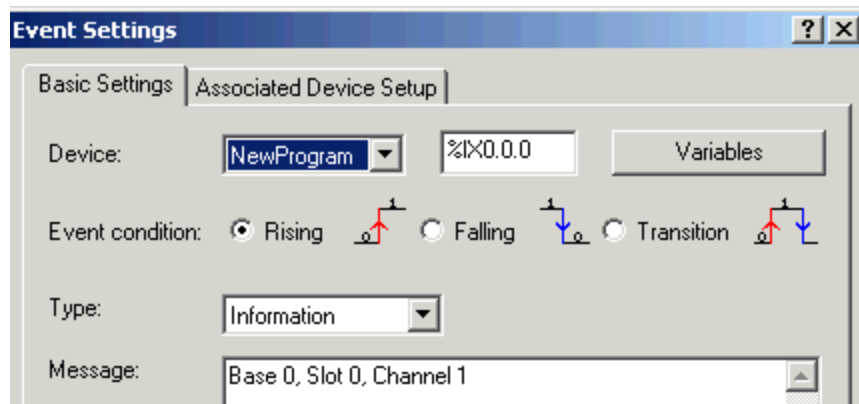

ID	Program	Variable	Device	Type
1	NewProgram		%MWO	INT
2	NewProgram		%QX0.0.0	BOOL
3	NewProgram		%MW2	INT

Custom Event					
Event Settings		Event History			
Number	Type	Event ID	Date	Time	Device
1	Information	3	2005-07-22	11:54:17:267	F00094
2	Information	1	2005-07-22	11:54:18:272	F00095
3	Information	3	2005-07-22	11:54:19:272	F00094

Function	Specification
Max # of variables that can be configured for custom event trigger	10 variables
Associated variables	Max 16 variables (bit, word, real data type) can be associated to the event for current value capture
Max buffer size for custom event capture in CPU	300 events
Variable type for event trigger	Only bit variables
Trigger condition	Rising, Falling, Transition options
Trigger Detection Speed	Scan time (milli-sec time stamping)
Event category	Information, Critical, Alarm
Applications	Trouble-shooting, Limited SOE

### ***RTC (Real-time Clock)***

MasterLogic-200 has a built-in clock (RTC) which runs on battery even in case of power failure. The RTC can be monitored & updated, if necessary, through:

- SoftMaster (manual command from GUI)
- Experion PKS server (auto sync with server clock)
- Programming instructions

All system events, custom events & errors logs are time stamped using RTC.

**Debug Modes**

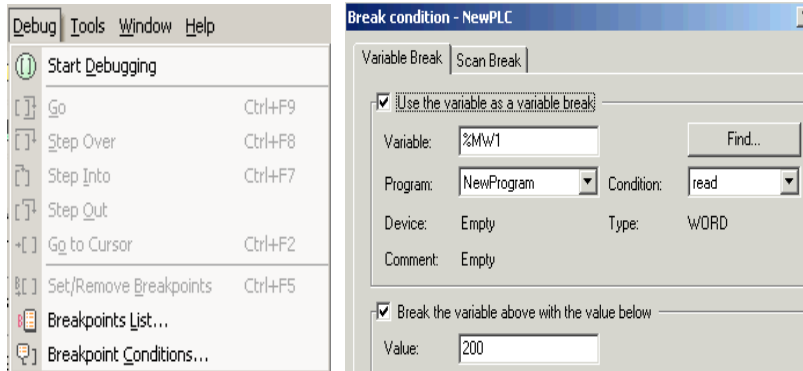

MasterLogic-200 program can be optionally started in DEBUG mode for any specific trouble-shooting. Breakpoints can be either:

- Manually set on / removed from any line of the program regardless of the programming language used.
- Set for trigger by internal memory variable or scan cycle count conditions

**PLC History - System alarm & events**

MasterLogic-200 CPU records four different types of system alarms & events occurring in PLC.

PLC history - NewPLC			
Error Log   Mode Log   Shut down Log   System Log			
Index	Date	Time	Contents
84	2005-08-18	18:41:33.001	Data trace, Use
85	2005-08-18	18:43:32.865	Momently shut-down
86	2005-08-18	18:46:09.001	Data trace, Use
87	2005-08-18	18:57:16.181	USB, OK, Connect
88	2005-08-18	18:57:19.876	USB, OK, Disconnect
89	2005-08-18	18:57:23.541	USB, OK, Connect

Event type	Description	Buffer Size in CPU
Error Log	Any error occurring in system – error code, timestamp, error details	2048 events

System Log	Operation history of key system events with timestamp	2048 events
Mode change Log	CPU mode changes, RUN/STOP/DEBUG with timestamp	1024 events
Power shutdown Log	Power ON/OFF, failure events with timestamp	1024 events

The event buffer in CPU is limited and FIFO cyclic. But all the above 4 types of PLC alarms & events can be archived in Experion and consolidated with Experion system alarms & events display. Please refer to MasterLogic-Experion Integration specification for further details.

## 1.6 Power Supply Modules (2MLI-CPUU)

There are four power supply modules with different specifications to choose from, according to the site requirements e.g. flexible voltage input range, DC input power, output voltages and current rating. The below specifications are applicable for CPU model: 2MLI-CPUU

Item		2MLP-ACF1	2MLP-ACF2	2MLP-AC23	2MLP-DC42
Input	Rated input voltage	AC 100V – AC 240V		AC 200V – AC 240V	DC 24V
	Input voltage range	AC 85V ~ AC 264V		AC 170V ~ AC 264V	-
	Input frequency	50 / 60 Hz (47 ~ 63 Hz)			-
	Inrush current	20 A <sub>Peak</sub> or less			80A <sub>Peak</sub> or less
	Efficiency	65% or more			60% or more
	Input fuse	Built-in (user no change), UL standard (Slow Blow Type)			
	Allowed instantaneous interruption	10 ms and shorter			
Output1	Output voltage	DC 5V ( $\pm 2\%$ )			DC5V ( $\pm 2\%$ )
	Output current	3.0A	6.0A	8.5A	6.0A
	Over current protect	3.2A or more	6.6A or more	9.0A or more	6.6A or more
	Over voltage protect	5.5V ~ 6.5V			
Output2	Output voltage	DC 24V ( $\pm 10\%$ )	-	-	-
	Output current	0.6A			
	Over current protect	0.7A or more			
	Over voltage protect	None			
Relay Output	Application	RUN contact			
	Rated switching voltage/current	DC 24V, 0.5A			
	Minimum switching load	DC 5V, 1 mA			



	Response time	OFF→ON/ ON→OFF: 10 ms or less/12 ms or less		
	Life	Mechanical life: 20 million and more times Electrical life: rated switching current: 100 thousand and more times		
Voltage indicator		Output voltage normal, LED ON		
Cable specification		0.75 ~ 2mm <sup>2</sup>		
Compressed terminal		RAV 1.25 - 3.5, RAV 2 - 3.5		
Weight		0.4kg	0.6kg	0.5kg

### Battery Specifications

Item	Specifications
Nominal voltage/current	DC 3.0V / 1,800mAh
Warranty period	5 years (at ambient temperature)
Purpose	Program and data backup, RTC operation when Power-OFF
Specification	Manganese dioxide lithium battery
Outer dimension (mm)	φ 17.0 X 33.5mm

## 1.7 Power Supply Modules (2MLR-CPUH/#)

There are four power supply modules with different specifications to choose from, according to the site requirements e.g. flexible voltage input range, DC input power, output voltages and current rating.

Item		2MLR-AC12	2MLR-AC22	2MLR-AC13	2MLR- AC23	2MLR-DC42
Input	Rated input voltage	110 VAC	220 VAC	110 VAC	220 VAC	24 VDC
	Input voltage range	85V~132VAC	176V~264VAC	85V~132VAC	176V~264VAC	19.2 ~ 28.8 VDC
	Input frequency	50 / 60 Hz (47 ~ 63 Hz)			-	
	Max. input power	110 VA / 42 W		176 VA / 72 W		-
	Inrush current	20A peak and lower (within 8 ms )			80A peak and lower	
	Efficiency	65% or higher				
	Input fuse	Built in(not replaceable by a user) - AC power: 250V / 3.15A ( Time-lag Type ) UL approved - DC power: 125V/10A (Time-lag type) UL approved				
Allowed instantaneous interruption	Within 20 ms					
Output	Output voltage	5VDC (±2%)				
	Output current	5.5A		8.5A		7.5A
	Output power	27.5W @ 55℃		46.75W @ 55℃		37.5W @ 55℃
	Over current protection	6.0 A ~ 13.0 A		9.3 A ~ 17.0 A		9.0 A~17.0 A
Relay Output	Purpose	RUN contact (refer to 8.2)				
	Rated switching voltage/current	24VDC, 0.5A				
	Min. switching load	5VDC, 1 mA				
	Response time	Off→On/ On→Off: 10 ms and lower/12 ms and lower				
Life	Mechanical life: 20 million and more times, electrical life: rated switching current: 100 thousand and more times					
Voltage status display	LED On when output voltage is normal					
Specification of cable	0.75 ~ 2 mm <sup>2</sup>					
Available clamped terminal	RAV1.25-3.5, RAV2-3.5					
Dimension (W x H x D mm)	55 x 95 x 90			55 x 95 x 110		
Weight	326g	382g	334g	384g	417g	

Applied base and install position	Power part of basic/extension base
-----------------------------------	------------------------------------

### Battery Specifications

Item	Specifications
Nominal voltage/current	DC 3.0V / 1,800mAh
Warranty period	5 years (at ambient temperature)
Purpose	Program and data backup, RTC operation when Power-OFF
Specification	Manganese dioxide lithium battery
Outer dimension (mm)	φ 17.0 X 33.5mm

## 1.8 Base options (2MLI-CPUU)

There are four I/O base options to select from: 4 slot, 6 slot, 8 slot & 12 slot bases. The below specifications are applicable only for CPU model: 2MLI-CPUU

### Main CPU base options

Model Item	2MLB-M12A	2MLB-M08A	2MLB-M06A	2MLB-M04A
No of Modules	12 modules	8 modules	6 modules	4 modules
Dimension (mm)	426 X 98 X 19	318 X 98 X 19	264 X 98 X 19	210 X 98 X 19
Weight (kg)	0.54	0.42	0.34	0.28

### Expansion I/O base options

<b>Model</b> <b>Item</b>	<b>2MLB-E12A</b>	<b>2MLB-E08A</b>	<b>2MLB-E06A</b>	<b>2MLB-E04A</b>
No of Modules	12 modules	8 modules	6 modules	4 modules
Dimension (mm)	426 X 98 X 19	318 X 98 X 19	264 X 98 X 19	210 X 98 X 19
Weight (kg)	0.59	0.47	0.39	0.33

#### Expansion I/O cable options

<b>Model</b> <b>Item</b>	<b>2MLC-E041</b>	<b>2MLC-E061</b>	<b>2MLC-E121</b>	<b>2MLC-E301</b>	<b>2MLC-E501</b>	<b>2MLC-E102</b>	<b>2MLC-E152</b>
Length (m) <sup>+</sup>	0.40	0.60	1.20	3.00	5.00	10.00	15.0
Weight (kg)	0.15	0.16	0.22	0.39	0.62	1.20	1.80

<sup>+</sup>The total cable length between the CPU and the farthest I/O expansion base should not exceed 15m.

**A. Main Base Board**

(Unit: mm)

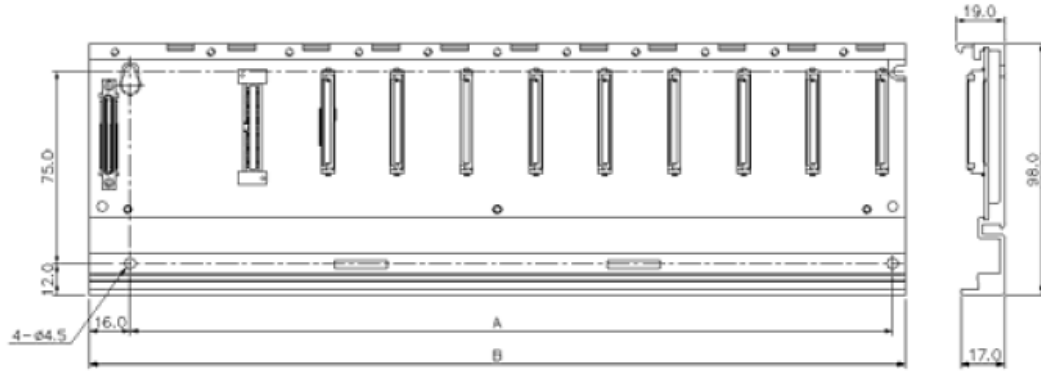

**B. Expansion Base Board**

(Unit: mm)

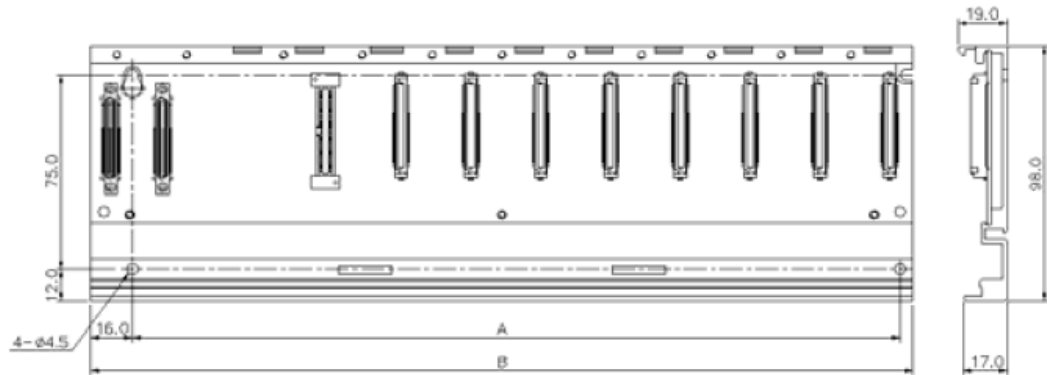

(Unit: mm)

## 1.9 Base Options (2MLR-CPUH/#)

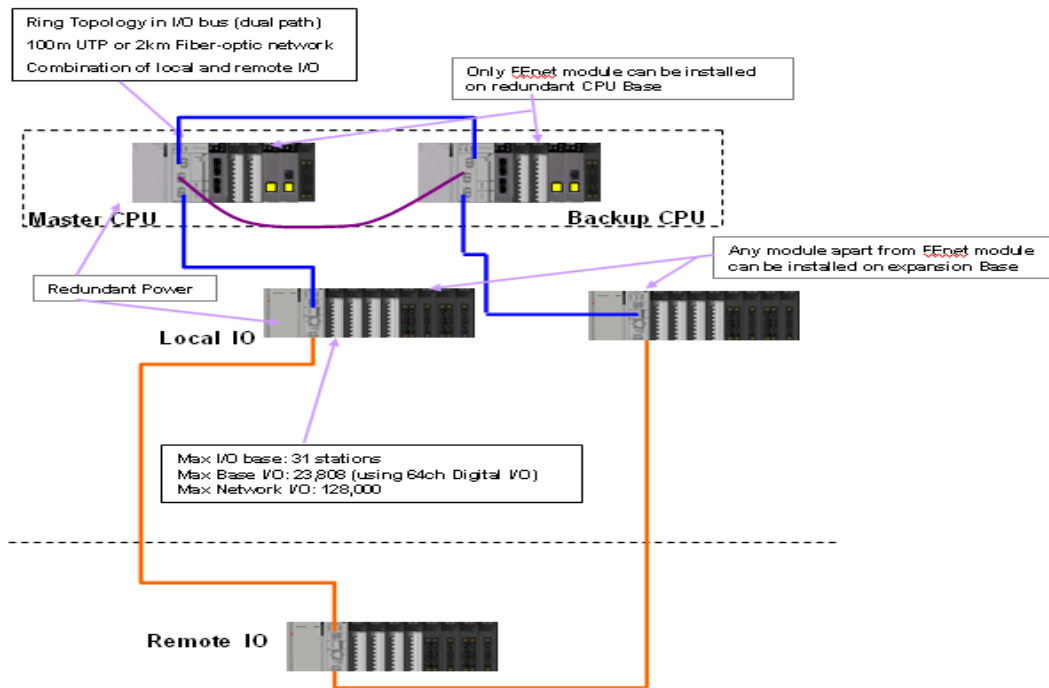

The above diagram demonstrates co-existence of both local I/O base and remote I/O base (i.e. UTP and fiber-optic cables) in a single I/O network.

**Please note that only FENet module can reside on CPU Base.  
FENet module can not be installed on the Expansion base.**

In redundant system employing CPU model: 2MLR-CPUH/#, Local I/O bases can communicate with the CPU via Industrial Ethernet using UTP CAT5 cable traveling up to a max 100m distance.

Remote I/O bases as far as 2km can communicate with the CPU on fiber-optic networks available in both CPU as well I/O base communication slave modules.

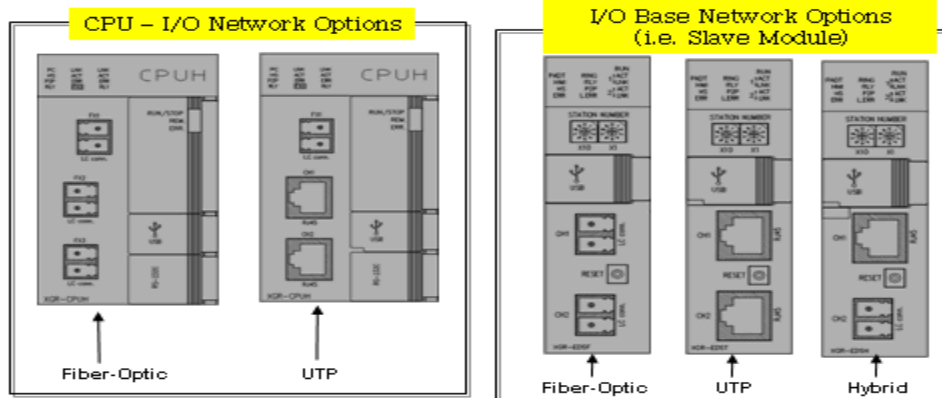

**Main CPU base options**

Item	Model	2MLR-M06P
No of Modules		6 modules
Dimension (mm)		346 X 98 X 19
Current Consumption (mA)		211
Weight		0.34 kg

**Expansion I/O base options**

Item	Model	2MLR-E12P
No of Modules		12 modules
Dimension (mm)		481 X 98 X 19
Current Consumption (mA)		220
Weight		0.59

(Unit: mm)

**A. Main Base Board**

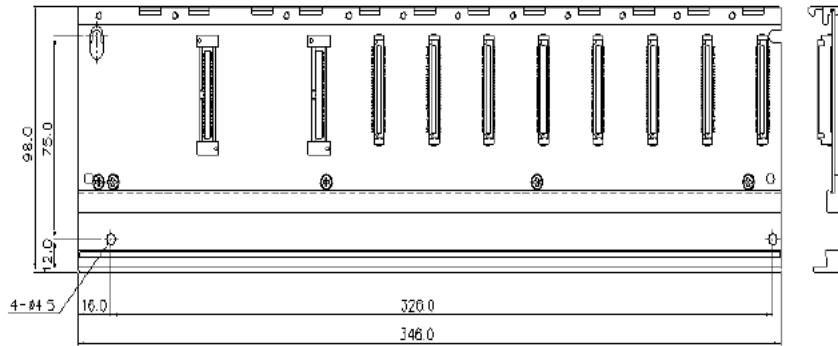

**B. Expansion Base Board**

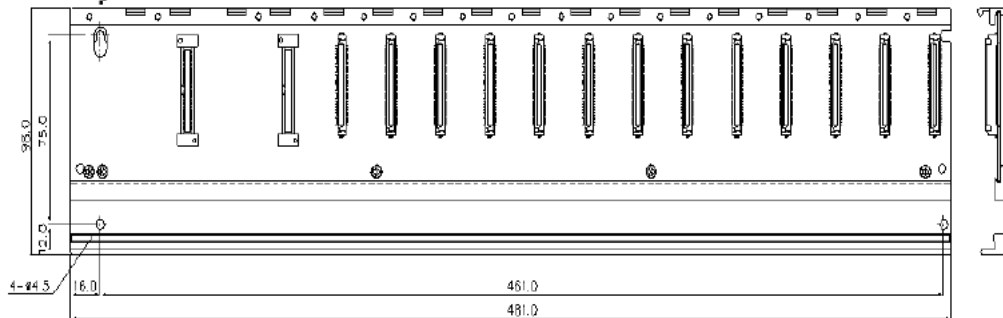



## 1.10 I/O Interface Modules (2MLR-CPUH/#)

Item	Specification			Remarks
	2MLR-DBSF	2MLR-DBST	2MLR-DBSH	
Media	Optical	Electrical	Mixed	
Max. distance between Extension bases	Optical (2km)	Electrical (100m)	Optical (2km) Electrical (100m)	
Cable Spec	62.5/125 Multi-mode Fiber LC type connector (Lucent Connector) Return Loss : over 45db			
Loader connection	Extension drive USB			
Range of station no.	1 ~ 31 (other no. will generate an error )			No.0: not available
Install position	CPU parts(CPU0 connector) in extension base			
Weight (g)	99	100	102	

## 2. Open networks

### 2.1 Network Summary Specifications

A wide range of open networking capability makes adds versatility to MasterLogic-200 PLC's scalable architecture. System engineers have an array of choices and features to design & construct a system architecture that is not just meeting the application but also renders high performance and bandwidth for future expansions.

		Fast Ethernet	Serial Comm	Profibus-DP
		FEnet	Snet	Pnet
Modules		2MLL-EFMT (T.P) 2MLL-EFMF (F.O)	2MLL-CH2A 2MLL-C22A 2MLL-C42A	2MLL-PMEA
Transmission Speed		100/10Mbps	300 ~ 11.5kbps	9.6k ~12Mbps
Physical Layer		IEEE802.3U - 100baseTx (T.P), 100baseFx (Fiber-Optic - Multi Mode)	RS232C / RS422 / 485	RS485
Distance		100m (Switch/Node , UTP/STP) 2Km (Switch/Node , Fiber Optic)	Max 500m (RS422/485)	Max 1.2Km
Max # of nodes		64	32	126 (32/segment)
Service / Protocol	HSL	√ (Peer-to-Peer)	-	√ (Profibus-DP)
	MLDP	√ (Experion Interface)	-	-
	Modbus slave	√ (MODBUS TCP slave)	√ (MODBUS RTU/ASCII slave)	-
	P2P	√ (MODBUS TCP master, User defined Protocol master)	√ (MODBUS RTU/ASCII master, User defined Protocol master)	-

	SoftMaster I/F	✓	✓	
Configuration Software	SoftMaster-NM		SoftMaster-NM & Sycon	
No of communication modules per CPU	Max 24 communication modules per CPU (Max 12 HSL services & 8 P2P services per CPU)			
Network Diagnostics	Auto-scan, Ping Test, Frame Monitor, Link Monitor, Loop back (as applicable)			

### HSL Service

High Speed Link can be defined as a communication service that performs bi-directional data transfers between:

- Two or more MasterLogic-200 PLCs (Peer-to-Peer)
- MasterLogic-200 and Profibus-DP devices (Pnet)

There can be a maximum of 12 HSL services per MasterLogic-200 CPU. Each HSL service can have a max of 128 blocks (either SEND or RECEIVE) and each block can handle of max of 200 words data size.

### P2P Service (point to point)

P2P service can be defined as a communication service that performs:

- MasterLogic acting as MODBUS master and third-party open devices as MODBUS slave (MODBUS RTU/ASCII master on serial or MODBUS TCP master on Ethernet)
- MasterLogic acting as User-Defined Communication master and third-party proprietary devices as slave (both serial and Ethernet TCP-IP)

There can be a maximum of 8 P2P services per MasterLogic-200 CPU. Each P2P service can have a max of 64 blocks (either READ or WRITE).

## 2.2 Fast Ethernet (FEnet)



### Overview

Open standard (IEEE802.3U) high speed Ethernet (FEnet) modules facilitate inter-connecting MasterLogic PLCs with either higher level computers or other peer PLCs on industrial Ethernet network. Network control uses industry standard Carrier Sense Multiple Access with Collision Detection (CSMA/CD) protocol. Two types of modules are available to choose depending on the distance and cabling philosophy.

- Twisted pair (UTP/STP-CAT5) media with RJ45 connector (100m)
- Fiber-optic (x62.5/125um, Multi-mode) media with SC connector (2km)

They provide a variety of services / functions / protocols:

- Peer-to-Peer integration with other MasterLogic PLCs
- Experion integration via special MasterLogic Dedicated Protocol (MLDP)
- MODBUS TCP-IP master / slave protocols
- SoftMaster Interface
- User-defined Protocol for interfacing with third-party devices

### Concurrent services

The above services are based on TCP-IP & UDP-IP protocols and thus many of the above processes can be concurrent, i.e. running at the same time in a single FEnet module. For example, a single FEnet module can be used for a) peer-to-

peer integration with other PLCs, b) Experion integration c) MODBUS TCP-IP master protocol d) SoftMaster I/F all at the same time. However, performance could be limited depending on the load.

### Specifications

		Fast Ethernet	
Modules		2MLL-EFMT	2MLL-EFMF
Ethernet Standard		IEEE802.3U	
Protocol		TCP-IP, UDP-IP	
Network Control Protocol (Access Method)		CSMA/CD	
Software Firewall		IP address settings in SoftMaster-NM	
Public Network Access		DNS server and Gateway IP address setting	
Dynamic IP address for ADSL		DHCP protocol	
Highway Topology (Transmission Method)		Baseband	
Transmission Speed		10/100 Mbps	100 Mbps
Physical Layer		100baseTx (T.P)	100baseFx (Fiber-Optic)
Media		UTP/STP, CAT5 (RJ45 connector)	x62.5/125um, Multi-mode, SC connector
Transmission Distance		100m (Switch/Node , UTP/STP)	2Km (Switch/Node , Fiber Optic)
Max # of nodes		64	
Service / Protocol	HSL	✓ (Peer-to-Peer High Speed Link with other MasterLogic PLCs)	
	HSL Send/Receive blocks	200 words / block, (Max. 128 blocks)	
	MLDP	✓ (Experion Interface – MasterLogic Dedicated Protocol)	
	Modbus TCP slave	✓ (MODBUS TCP slave protocol)	
	P2P	✓ (MODBUS TCP master, User defined Protocol master)	
	SoftMaster I/F	✓	
Configuration Software		SoftMaster-NM	
LEDs		RUN, I/F, HS, P2P, PADT, PC, ERR, TX, RX, 10/100	
Network Diagnostics		Auto-scan, Ping Test, Frame Monitor, Link Monitor	
Current Consumption (mA)		410	630

Weight (g)	105	120
------------	-----	-----

### HSL Service - Peer-to-Peer network of MasterLogic-200 PLCs

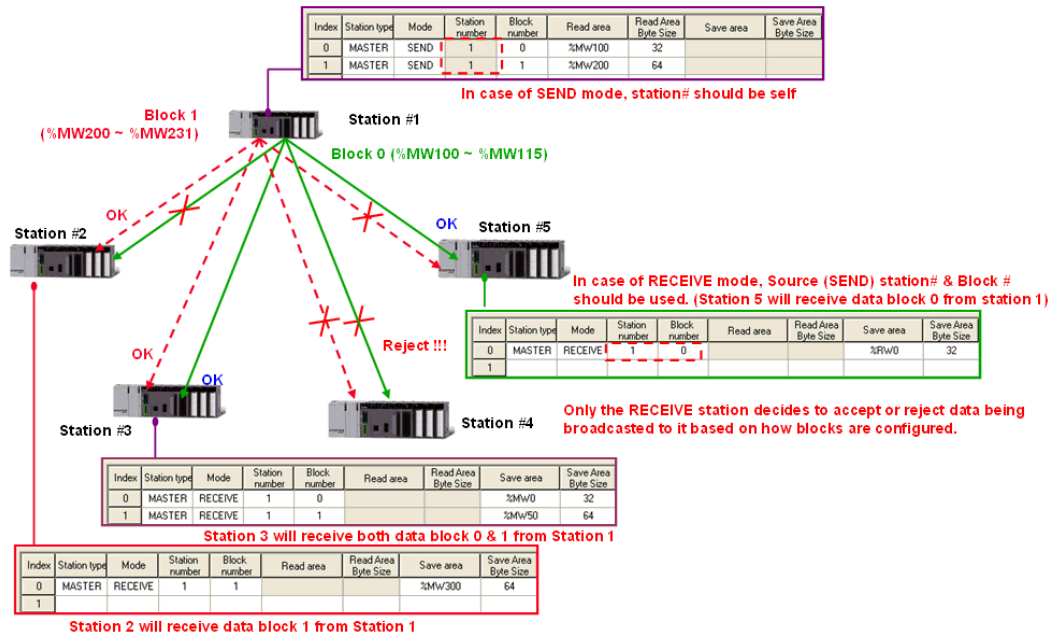

High Speed Link (HSL) services in Fast Ethernet module (FEnet) ensures efficient and reliable peer-to-peer networking of MasterLogic-200 PLCs.

In the above example, there are five PLCs (Station#1 ~ 5) configured for peer-to-peer network. Station#1 is configured with 2 “send” blocks which are broadcasted to rest of all the stations in the network. Only the station with “receive” blocks decides to accept or reject the broadcast packet based on parameters.

Read and Write parameters define the memory areas & size of data transfer for each block. Thus the engineer can configure and get peer-to-peer function working within a few minutes by few clicks and keys.

A max of 128 blocks can be configured in each HSL service and each block can handle of max of 200 words data size. Out of 128, a max of 64 blocks can be configured as “send” and the rest as “receive” blocks. A max of 64 MasterLogic

PLCs (stations) can be connected in a single network for peer-to-peer functionality.

### MasterLogic Dedicated Protocol (MLDP) - Experion Integration

The high speed Ethernet communication modules (FEnet) of MasterLogic-200 system can reside on FTE network providing a high-level interface with Experion PKS servers.

MLDP (MasterLogic Dedicated Protocol) server embedded in these modules offer Experion servers, a special proprietary access on TCP-IP layer to various memory variables of the CPU. For more details on this interface, please refer to MasterLogic-Experion Integration section.

### MODBUS TCP-IP Slave Protocol

Instead of proprietary MLDP server protocol as above, the FEnet module can be configured to serve open standard MODBUS TCP-IP slave protocol for allowing any third-party controllers / HMI / SCADA to communicate with MasterLogic PLCs.

MODBUS Settings (read / write addresses) can be configured as per requirements.

Function Code	Description	Modbus Address	Remarks	Response size*
01	Output Contact Status Read (Read Coil Status)	0XXXX (bit-output)	Bit read	2000 coils
02	Input Contact Status Read (Read Input Status)	1XXXX (bit-input)	Bit read	2000 coils
03	Output Register Read (Read Holding Registers)	4XXXX (word-output)	Word Read	125 registers
04	Input Registers Read (Read Input Registers).	3XXXX (word-input)	Word Read	125 registers

05	Output Contact 1 Bit Write (Force Single Coil)	0XXXX (bit-output)	Bit write	1 coil
06	Output Register 1 Word Write (Preset Single Register)	4XXXX (word-output)	Word Write	1 register
15	Output Contact Continuous Write (Force Multiple Coils)	0XXXX (bit-output)	Bit Write	1600 coils
16	Output Register Continuous Write (Preset Multiple Register)	4XXXX (word-output)	Word Write	100 registers

**SoftMaster I/F Service**

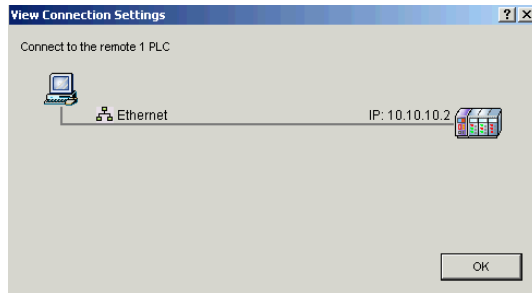

Every FENet module has a ready built-in service for SoftMaster using TCP-IP Port 2002. This service is automatic and can be in the background along with other services.

Any SoftMaster application (programming software) can connect to the PLC via any of its FENet module at any time

irrespective of other functions already being performed by the FENet module.

**P2P Service – MODBUS TCP-IP master**

The same FENet module can act as MODBUS TCP-IP master communicating with other third-party MODBUS TCP-IP slave devices, controllers, RTUs etc. In this architecture, MasterLogic PLC would be the master initiating read/write commands with other MODBUS TCP slave devices using TCP-IP port 502.

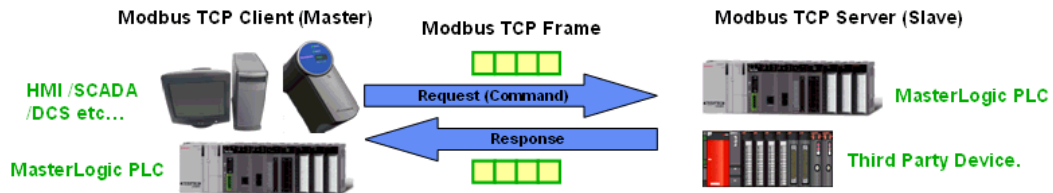



**P2P Service – User-Defined Protocol**

This is another unique feature in MasterLogic PLC. Some devices do not support open standard protocols such as MODBUS-TCP but only proprietary protocols providing access to special data areas / functions within the device.

MasterLogic PLC engineers do not fret during such situations. The FENet module allows configuring user-defined protocol using simple “Frame Editor” techniques to communicate with any third-party devices on special protocols.

Using “SoftMaster-NM” utility, “Send” and “Receive” frames can be configured with following options:

- Header, Data and Tail sections
- Numeric and String Constants
- Data frame with Fixed size & varying size variables
- Automatic BCC calculation
- Hex or ASCII conversions
- Transmitting frame controlled by user condition or system clock (100ms, 200ms, 1sec...)
- Receiving frame & writing to memory variable area is automatic

## 2.3 Serial Communication (Snet)



### Overview

Like Ethernet, Serial Communication (Snet) modules add versatility and openness to MasterLogic architecture. Open standard RS232C/ RS422 / RS485 modules facilitate communication of MasterLogic PLCs with a wide range of serial devices i.e. RTU, panels, weigh bridges, barcode readers, high level computers or even other PLCs.

Three types of modules are available to choose depending on the distance and the partner device.

- Two ports of RS232C
- Two ports of RS422/485
- One RS232C port and one RS422/485 port

They provide a variety of services / functions / protocols:

- MODBUS RTU/ASCII master / slave protocols
- SoftMaster Interface
- User-defined Protocol for interfacing with third-party devices

**Specifications**

		<b>Serial Interface (Snet)</b>		
Modules		2MLL-C22A	2MLL-C42A	2MLL-CH2A
Interface Standard		RS232C – 2 ch	RS422/485 – 2 ch	1 ch – RS232C 1 ch – RS422/485
Modem connection with remote devices		✓	-	✓ (only on RS232C port)
Communication Settings (SoftMaster-NM)	Start Bit	1		
	#Data Bits	7 or 8		
	Stop Bits	1 or 2		
	Parity	Odd/Even/None		
	Baud rate	Options: 300 / 600 / 1200 / 2400 / 4800 / 9600 / 19200 / 38400 / 57600 / 115200 bps		
Synchronization		Asynchronous		
Transmission Distance		15m (extendable by modem / phone line)	500m max	RS232C - 15m (extendable by modem) RS422 - 500m max
Network Configuration		1:1	1:1, 1:N, N:M	RS232C - 1:1 RS422 - 1:1, 1:N, N:M
Station No Setting		Setting range : 0-31 (Max. station No. available : 32 stations)		
Service / Protocol	Modbus RTU / ASCII slave	✓		
	P2P	✓ (MODBUS RTU/ASCII master, User defined Protocol master)		
	SoftMaster I/F	✓		
Configuration Software		SoftMaster-NM		
LEDs		RUN, I/F, TX, RX, ERR		
Network Diagnostics		Auto-scan, Frame Monitor, Link Monitor, Loop back		
Current Consumption (mA)		310	300	310
Weight (g)		121	116	119

**MODBUS RTU / ASCII Slave Protocol**

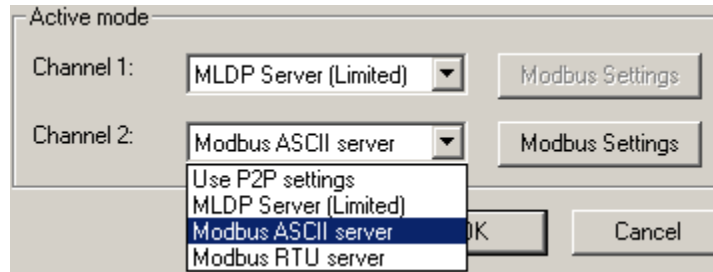

The Snet module can be configured to serve open standard MODBUS RTU or ASCII slave protocol for allowing any third-party controllers / HMI / SCADA to communicate with MasterLogic PLCs.

MODBUS Settings (read / write addresses) can be configured as per requirements.

**SoftMaster I/F Service**

Every Snet module has a ready built-in service for SoftMaster software to connect to the PLC for program download / upload functions.

**P2P Service – MODBUS RTU / ASCII master**

The same Snet module can act as MODBUS RTU / ASCII master communicating with other third-party MODBUS slave devices, controllers, RTUs etc. In this architecture, MasterLogic PLC would be the master initiating read/write commands with other MODBUS slave devices.

Channel	Operating Mode	P2P Driver
1	Modbus RTU server	
2	Use P2P	<div style="border: 1px solid black; padding: 2px;">                     User frame definition                      MLDP client                      Modbus ASCII client                      Modbus RTU client                 </div>

**P2P Service – User-Defined Protocol**

This is another unique feature in MasterLogic PLC. Some serial devices do not support open standard protocols such as MODBUS but only proprietary protocols providing access to special data areas / functions within the device.

Like the FEnet module, the Snet module allows configuring user-defined protocol using simple “Frame Editor” techniques to communicate with any third-party devices on special protocols.

Using “SoftMaster-NM” utility, “Send” and “Receive” frames can be configured with following options:

- Header, Data and Tail sections
- Numeric and String Constants
- Data frame with Fixed size & varying size variables
- Automatic BCC calculation
- Hex or ASCII conversions
- Transmitting frame controlled by user condition or system clock (100ms, 200ms, 1sec...)
- Receiving frame & writing to memory variable area is automatic

## 2.4 Profibus-DP (Pnet)

### Overview

Pnet I/F module is one of the communication modules of MasterLogic-200 PLC system. It uses token ring topology to control the communication and configure the network. Pnet I/F module uses a shielded Twisted Pair Copper Cable to control the fieldbus

This module has the following characteristics

- Conforms to the international standard of EN 50170
- Supports Auto Baud Rate Detect
- Supports Sync/Freeze mode
- Maximum data input: 64 Bytes/Slave
- Maximum data output: 64 Bytes/Slave
- Maximum data size: 128 Bytes/Slave, 6 KB/Master
- Communication speed: 9.6K, 19.2K, 93.7K, 187.5K, 500K, 1.5M, 3M, 6M, 12M

### Specifications

Profibus-DP (Pnet)	
Module Type	Master
Network Type	Profibus-DP
Standard	EN50170/DIN19245
Interface	RS-485 (Electric)
Transmission Route	Bus type
Modulation Type	NRZ

MAC	Local Token Ring	
Max. Distance & Transmission Speed	Distance (m)	Transmission Speed (bps)
	1,200	9.6K/19.2K/93.7K/187.5K
	400	500K
	200	1.5M
	100	3M/6M/12M
Max. number of stations per Profibus network	126	
Max. number of stations per segment	32 (including master & repeater)	
Cable used	Electric-twist shielded pair cable	
Max. communication size	7 Kbytes	
Max. size per slave	244 bytes	
Max. number of Profibus-DP Master Modules per CPU	12	
Configuration Tool	SoftMaster-NM, SyCon	
Current Consumption (mA)	550	
Weight (g)	114	

## 3. SoftMaster

### Overview

SoftMaster is a software tool designed to program and debug MasterLogic 200. It provides integrated PLC programming environment.

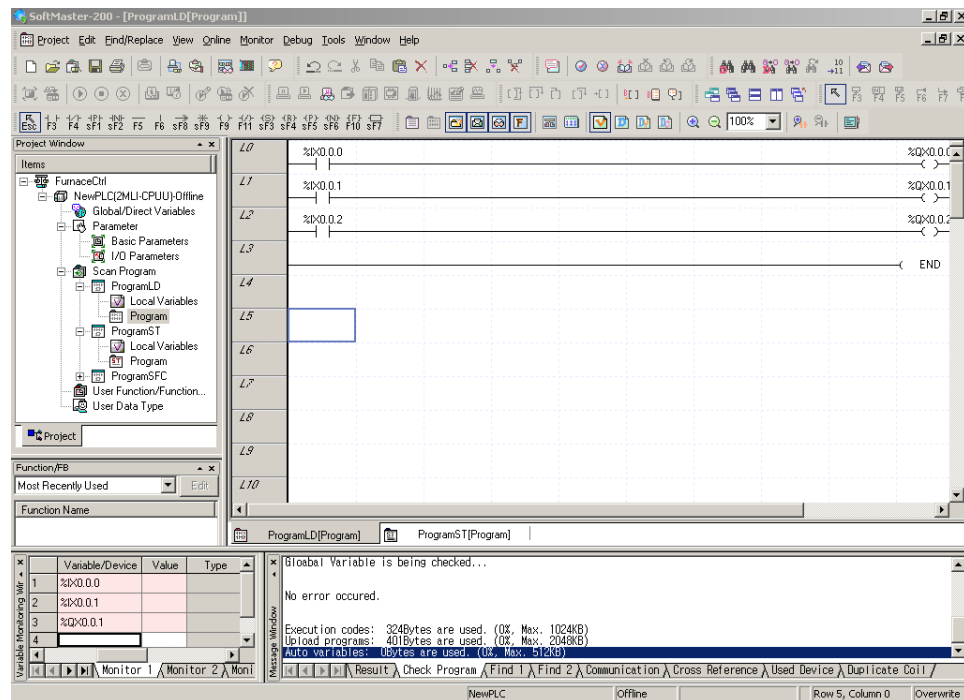

### Project Management

- Program multiple PLCs through a single window
- One project file (.xgp) as central storage for complete PLC info
- Compare project files to detect minor differences



- Import / Export entire PLC or selectively individual component
- Flexible documentation – entire PLC data or selectively

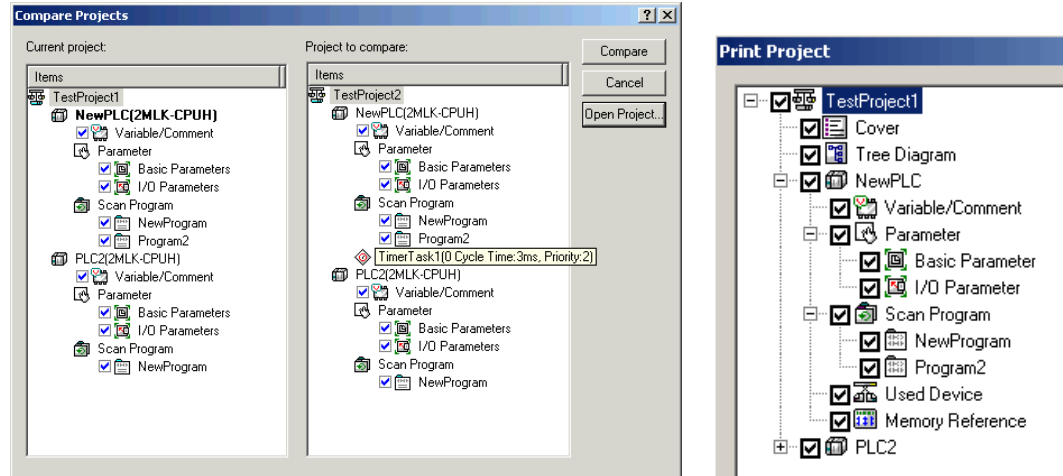

**Options to connect to PLCs**

- USB, RS232C, Ethernet (TP or Fiber-optic)
- Direct connection to PLC or two levels of remote connection to PLC via a communication module

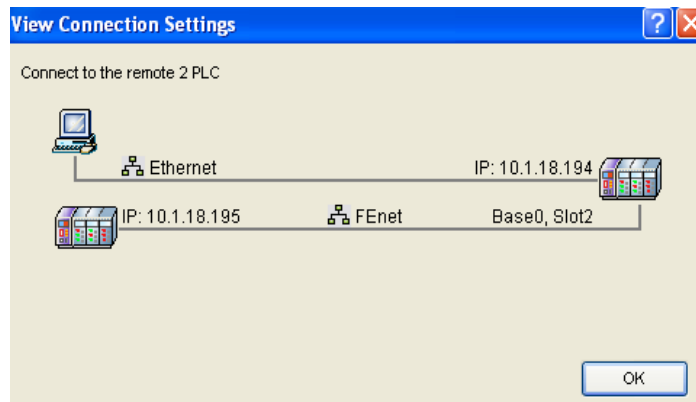

**User defined function blocks**

SoftMaster in association with MasterLogic-200 CPU allows the creation of password protected user defined function blocks. A user can build the custom logic & strategies in these function blocks using configurable input and output parameters & data types. These user defined function blocks can be password protected for security and copyright purposes

**User defined data types**

SoftMaster allows the creation of user defined data types in addition to the standard IEC data types.

**Monitoring**

When SoftMaster is in connected mode, it allows monitoring of the below functions:

1. Program Monitoring
2. Variable Monitoring
3. System Monitoring
4. Address Monitoring
5. Special Module Monitoring
6. Trend Monitoring
7. Data Traces

**Debugging**

SoftMaster allows program debugging with advanced features like Step Over, Step Into, Step Out and Conditional Breakpoints.

**Online**

SoftMaster provides the following features when it is connected with PLC:

1. Online Editing
2. Write programs to PLC
3. Read programs from PLC
4. Change Operation Mode (RUN/STOP/DEBUG)
5. Reset / Clear PLC

6. View PLC information / history / errors and warnings
7. Specify Flash Memory Setting
8. Forced I/O / Skip I/O Setting
9. Fault Mask Setting
10. Online Module Replacement

### **Simulation**

Simulation allows an engineer to programs without PLC, or debug program by using input condition setting or module simulation function.

The following features are supported by the simulation environment:

1. Program simulation  
The program written in LD/SFC/ST can be simulated. Online editing and debugging is supported by the simulation environment.
2. PLC online function  
The program monitoring and online diagnostic functions (e.g. system monitoring / device monitoring) can be used during simulation.
3. Module simulation  
Digital I/O module, A/D conversion module, D/A conversion module, High counter, Temperature control module can be simulated.
4. I/O input condition setting  
Simulation environment supports setting device value or channel value of the I/O module as an input condition.

**System Requirements**

<b>System Configuration</b>	<b>Minimum</b>
Processor	2.0 GHz Pentium IV or faster
RAM	128 MB
Video Resolution	1024 x 768
Hard Drive	10 GB
Operating System	Windows XP/SP2, Windows Vista
External Interface	RS232 Serial or USB

## 4. Model Numbers

### 4.1 CPU modules

Product	Model	Description	Remarks
CPU Module	2MLI-CPUU	High speed CPU module (Fully Non-redundant system) (Max. I/O point: 6,144 points)	
	2MLR-CPUH/T	High speed CPU module (Fully Redundant system), Master, TP/CAT5 (Max. I/O point: 23,808 points)	
	2MLR-CPUH/F	High speed CPU module (Fully Redundant system), Master, Fiber Optic (Max. I/O point: 23,808 points)	

### 4.2 I/O base, cables (2MLI-CPUU)

Product	Model	Description	Remarks
Main CPU Base (only for 2MLI-CPUU)	2MLB-M04A	For 4 module installation	
	2MLB-M06A	For 6 module installation	
	2MLB-M08A	For 8 module installation	
	2MLB-M12A	For 12 module installation	
Expansion I/O Base (only for 2MLI-CPUU)	2MLB-E04A	For 4 module installation	
	2MLB-E06A	For 6 module installation	
	2MLB-E08A	For 8 module installation	
	2MLB-E12A	For 12 module installation	

Product	Model	Description	Remarks
Power module (only for 2MLI-CPUU)	2MLP-ACF1	AC 100V~240V input, DC 5V: 3A, DC 24V: 0.6A	
	2MLP-ACF2	AC 100V~240V input DC 5V: 6A	
	2MLP-AC23	AC 100V~240V input DC 5V: 8.5A	
	2MLP-DC42	DC 24V Input DC 5V: 6A	
Expansion I/O cable (only for 2MLI-CPUU)	2MLC-E041	Length: 0.4m	Total extension distance should not exceed 15m
	2MLC-E061	Length: 0.6m	
	2MLC-E121	Length: 1.2m	
	2MLC-E301	Length: 3.0m	
	2MLC-E501	Length: 5.0m	
	2MLC-E102	Length: 10.0m	
	2MLC-E152	Length: 15.0 m	

### 4.3 I/O base, I/O interface modules, cables (2MLR-CPUH)

Product	Model	Description	Remarks
Main CPU Base (for 2MLR- CPUH/T, 2MLR- CPUH/F)	2MLR-M06P	CPU base for 6 module installation	

Product	Model	Description	Remarks
Expansion I/O Base (for 2MLR-CPUH/T, 2MLR-CPUH/F)	2MLR-E12P	I/O Base for 12 module installation	
Power module (for 2MLR-CPUH/T, 2MLR-CPUH/F)	2MLR-AC13	Power Module, 8.5A, Voltage (AC110V)	
	2MLR-AC23	Power Module, 8.5A, Voltage (AC220V)	
	2MLR-AC12	Power Module, 5.5A, Voltage (AC110V)	
	2MLR-AC22	Power Module, 5.5A, Voltage (AC220V)	
	2MLR-DC42	Power Module, 7.5A, Voltage (DC24V)	
I/O interface modules (for 2MLR-CPUH/T, 2MLR-CPUH/F)	2MLR-DBSF	I/O Interface Module, Fiber Optic	
	2MLR-DBST	I/O Interface Module, TP/CAT5	
	2MLR-DBSH	I/O Interface Module, Hybrid (Fiber Optic & TP/CAT5)	

#### 4.4 Digital I/O modules

Product	Model	Description	Remarks
Digital Input Module	2MLI-D21A	DC 24V Input, 8 point (Current source / sink input)	
	2MLI-D22A	DC 24V Input, 16 point (Current source / sink input)	
	2MLI-D24A	DC 24V Input, 32 point (Current source / sink input)	

Product	Model	Description	Remarks
	2MLI-D28A	DC 24V Input, 64 point (Current source / sink input)	
	2MLI-D22B	DC 24V Input, 16 point (Current source input)	
	2MLI-D24B	DC 24V Input, 32 point (Current source input)	
	2MLI-D28B	DC 24V Input, 64 point (Current source input)	
	2MLI-A12A	AC 110V input, 16 point	
	2MLI-A21A	AC 220V input, 8 point	
Digital Output Module	2MLQ-RY1A	Relay output, 8 point (for 2A, single COM.)	
	2MLQ-RY2A	Relay output, 16 point (for 2A)	
	2MLQ-RY2B	Relay output, 16 point (for 2A), Varistor included	
	2MLQ-TR2A	Transistor output, 16 point (for 0.5A, Sink output)	
	2MLQ-TR4A	Transistor output, 32 point (for 0.1A, Sink output)	
	2MLQ-TR8A	Transistor output, 64 point (for 0.1A, Sink output)	
	2MLQ-TR2B	Transistor output 16 point (for 0.5A, Source output)	
	2MLQ-TR4B	Transistor output 32 point (for 0.1A, Source output)	
	2MLQ-TR8B	Transistor output 64 point (for 0.1A, Source output)	
	2MLQ-SS2A	Triac output, 16 point (for 0.6A)	



## 4.5 Analog I/O, HSC Modules

Product	Model	Description	Remarks
Analog Input modules	2MLF-AV8A	<ul style="list-style-type: none"> <li>Voltage Input: 8 channels</li> <li>DC 1 ~ 5V / 0 ~ 5V / 0 ~ 10V / -10 ~ +10V</li> </ul>	
	2MLF-AC8A	<ul style="list-style-type: none"> <li>Current Input: 8 channels</li> <li>DC 4 ~ 20mA / 0 ~ 20mA</li> </ul>	
	2MLF-AD8A	<ul style="list-style-type: none"> <li>Voltage/Current Input: 8 channels</li> </ul>	
	2MLF-AD16A	<ul style="list-style-type: none"> <li>Voltage/Current Input: 16 Channels</li> </ul>	
	2MLF-AD4S	<ul style="list-style-type: none"> <li>Voltage/Current Input: 4 channels</li> <li>Isolation between channels</li> </ul>	
Analog Output modules	2MLF-DV4A	<ul style="list-style-type: none"> <li>Voltage Output: 4 channels</li> <li>DC 1 ~ 5V / 0 ~ 5V / 0 ~ 10V / -10 ~ +10V</li> </ul>	
	2MLF-DC4A	<ul style="list-style-type: none"> <li>Current Output: 4 channels</li> <li>DC 4 ~ 20mA / 0 ~ 20mA</li> </ul>	
	2MLF-DC4S	Current Output: 4 channels, Isolation between channels	
	2MLF-DV8A	<ul style="list-style-type: none"> <li>Voltage Output: 8 channels</li> <li>DC 1 ~ 5V / 0 ~ 5V / 0 ~ 10V / -10 ~ +10V</li> </ul>	
	2MLF-DC8A	<ul style="list-style-type: none"> <li>Current Output: 8 channels</li> <li>DC 4 ~ 20mA / 0 ~ 20mA</li> </ul>	
Thermocouple Input Module	2MLF-TC4S	Temperature (T/C) Input, 4 channels, Isolation between channels	
RTD Input Module	2MLF-RD4A	Temperature (RTD) Input, 4 channels	
High speed Counter Module	2MLF-HO2A	<ul style="list-style-type: none"> <li>Voltage Input type (Open Collector type)</li> <li>200 kHz, 2 channel</li> </ul>	
	2MLF-HD2A	<ul style="list-style-type: none"> <li>Differential Input type (Line Driver type)</li> <li>500 kHz, 2 channel</li> </ul>	

## 4.6 Communication Modules

Product	Model	Description	Remarks
FEnet Module (Optical/ Electrical)	2MLL-EFMF	<ul style="list-style-type: none"> <li>Fast Ethernet (multi-mode fiber-optic media), Master</li> <li>100/10Mbps support</li> </ul>	
	2MLL-EFMT	<ul style="list-style-type: none"> <li>Fast Ethernet (CAT 5 media), Master</li> <li>100/10Mbps support</li> </ul>	
Snet Module	2MLL-C22A	<ul style="list-style-type: none"> <li>Serial communication</li> <li>RS-232C, 2 channels</li> </ul>	
	2MLL-C42A	<ul style="list-style-type: none"> <li>Serial communication</li> <li>RS-422 (485), 2 channels</li> </ul>	
	2MLL-CH2A	<ul style="list-style-type: none"> <li>Serial communication</li> <li>RS-232C 1 Channel / RS-422 (485) 1 Channel</li> </ul>	
Profibus-DP Module	2MLL-PMEA	Profibus-DP Master Module	

## 4.7 Programming Cables

Product	Model	Description	Remarks
USB cable	USB-301A	Programming cable for USB port	

## 4.8 Software Environment

Product	Model	Description	Remarks
---------	-------	-------------	---------

SoftMaster	SSS-MLPT	Programming tool for MasterLogic PLC	
Experion PKS Interface Driver (Not required for Experion HS / LS)	SSS-MLDP	Driver for integration with Experion PKS	

## 4.9 Others

Product	Model	Description	Remarks
Terminator	2MLT-TERA	Must use for base expansion	
Dummy module	2MLT-DMMA	Dust protection module for unused slot	

Experion, PlantScape, TotalPlant are U.S. registered trademarks of Honeywell International Inc. All other products and brand names shown are trademarks of their respective owners.

While this information is presented in good faith and believed to be accurate, Honeywell disclaims the implied warranties of merchantability and fitness for a particular purpose and makes no express warranties except as may be stated in its written agreement with and for its customer. In no event is Honeywell liable to anyone for any indirect, special or consequential damages. The information and specifications in this document are subject to change without notice

**For More Information**

Learn more about Honeywell's products/solutions visit our website [www.honeywell.com/ps](http://www.honeywell.com/ps) or contact your Honeywell account manager.

**Automation & Control Solutions**

Process Solutions  
Honeywell  
2500 W. Union Hills Dr.  
Phoenix, AZ 85027  
Tel: 877.466.3993 or 602.313.6665

00-00-000  
May 2010  
© 2010 Honeywell International Inc.

